

General Notes

- The purpose of this SP amendment is to increase number of multi-family residential units to 48, increase height to 4 stories, and make other minor changes to the approved SP (BL2016-404)
 - This Property Is Not Included In An Area Designated "Special Flood Hazard" On The Federal Emergency Management Agency Flood Maps Available To Me At This Time. Community Map: 47037C0239 F Panel 239, Effective Date: April 21, 2001.
 - The Utilities Shown Hereon Are Based On Field Observations And Information Obtained For The Utility District. Prior To Any Excavation The Exact Location Of The Underground Utilities
 - The contractor's work to be performed under this project will consist of furnishing all equipment, labor, materials, tools and supervision necessary for the construction of the proposed Apartment Complex and other related work as listed in the plans and specifications.
 - The contractor shall verify all dimensions, utility locations, elevations, existing inverts prior to ordering any material. If a discrepancy is found, the contractor shall notify the engineer or representative immediately.
 - All work shall comply with all local, state and federal codes and laws. All necessary licenses and permits not obtained by the owner shall be the contractor's responsibility.
 - All materials shall be new unless used or salvaged materials are authorized by owner.
 - The concrete shall have a 3000 psi minimum compressive strength in 28 days. Maximum slump shall be 4 inches, unless noted otherwise.
 - All site concrete shall be finished with a fine hair broom.
 - All work performed shall be in the best recognized trade practices and to the entire satisfaction of the owner.
 - All handicap ramp curb shall be painted yellow in transition areas.
- Stormwater**
- Any excavation, fill, or disturbance of the existing ground elevation must be done in accordance with storm water management ordinance No. 78-840 and approved The Metropolitan department of Water Services.
 - The Buffer along waterways will be an area where the surface is left in a natural state and is not disturbed by construction activity. This is in accordance with the Stormwater Management Manual Volume 1 - Regulations.
 - Drawings are for illustration purposes to indicate the basic premise of the development as it pertains to Stormwater approval/comments only. The final lot count and details of the plan shall be governed by the appropriate stormwater regulations at the time of approval of final application.
 - Metro Water Services shall be provided sufficient and unencumbered access in order to maintain and repair utilities in this site.
 - Size driveway culverts per the design criteria set forth by the Metro Stormwater Management Manual. Minimum driveway culvert in Metro ROW is 15" CMP.
 - By graphic plotting only, this property is in Zone(s) "X" of the Flood Insurance Rate Map Community Panel No. 47037C0264H which bears an effective revised date of April 5, 2017. No field surveying was performed to determine this zone and an elevation certificate may be needed to verify this determination or apply for a variance from the Federal Emergency Management Agency
 - The Utilities Shown Hereon Are Based On Field Observations And Information Obtained For The Utility District. Prior To Any Excavation The Exact Location Of The Underground Utilities Should Be Determined. Tennessee One-call 1-800-351-1111.

Nashville Electric Service

- NES riser pole should be installed on development property.
- If underground power is to run through the ingress/egress/water line easement, it will need to be PUDE.
- NES need to know how the property will be platted.
- If it becomes necessary to cross an adjacent piece of property in order to serve this development, the owner will be responsible for acquiring easement to do so.
- NES can meet with developer upon request to determine service options.
- Developer drawing shall show any existing utilities easements on property, the utility poles on the property and the poles along ROW.
- Postal plan is required before NES's final construction drawings can be approved.
- NES needs any drawings that will cover any road improvements.
- Nes follows the National Fire Protection Association rules; Refer to NFPA 70 article 450-27; and NESC Section 15-152.A2 for complete rules (see NES Construction Guidelines under "Builders and Contractors" tab @ www.nespower.com.
- Quantity and location of transformers to be determined by the NES Engineer after receiving final plans and electrical load information. An Exhibit 'B' design will be sent to the developer or representatives of the developer for review. Suggestions or requests to the design should be made during this review process. Any changes requiring re-design, after this document has been signed, will be at the developer's expense.
- Developer's vegetation design shall meet both Metro requirements and NES Vegetation Management requirements/clearances.
- NES facilities will not be allowed to sit in or to pass through retention areas including rain gardens, bio-retention, bio swales and the like. This includes primary duct between pad-mounted equipment, as well as service duct to a meter or meter center.
- NES needs electrical load information on the apartments including any three phase power requirements, house services, trash compactors, irrigation or the like.

NDOT (Nashville Department of Transportation)

- This development will require NDOT approval of detailed construction plans prior to grading the site. Plans must comply with the design regulations established by the Department of NDOT in effect at the time of approval of the preliminary development plan or final development plan or final development plan or building permit, as applicable. Final design and improvements may vary based on actual field conditions.

A New Multiple Family Home Complex Apartment Concept

SP Amendment
1636 Lebanon Pike
Nashville, Tennessee
Davidson County

PARCEL NUMBERS 09400005000 AND 09400004900

MURRAY D. SHANKLIN P.E. DESIGNER

P.O. BOX 9

PORTLAND, TN 37148

Ph. 615 512-2911

ROBERT L. BERNARD OWNER

334 RAYMOND HODGES ROAD

COTTONTOWN, TN 37048

Case Number: 2016SP-29-002

Ph. 615 521-2335

Development Summary:
COUNCIL DISTRICT NO. 15
COUNCIL PERSON: JEFF SYRACUE
Case Number: 2016SP-29-002
Grading Permit Number: 2018020023

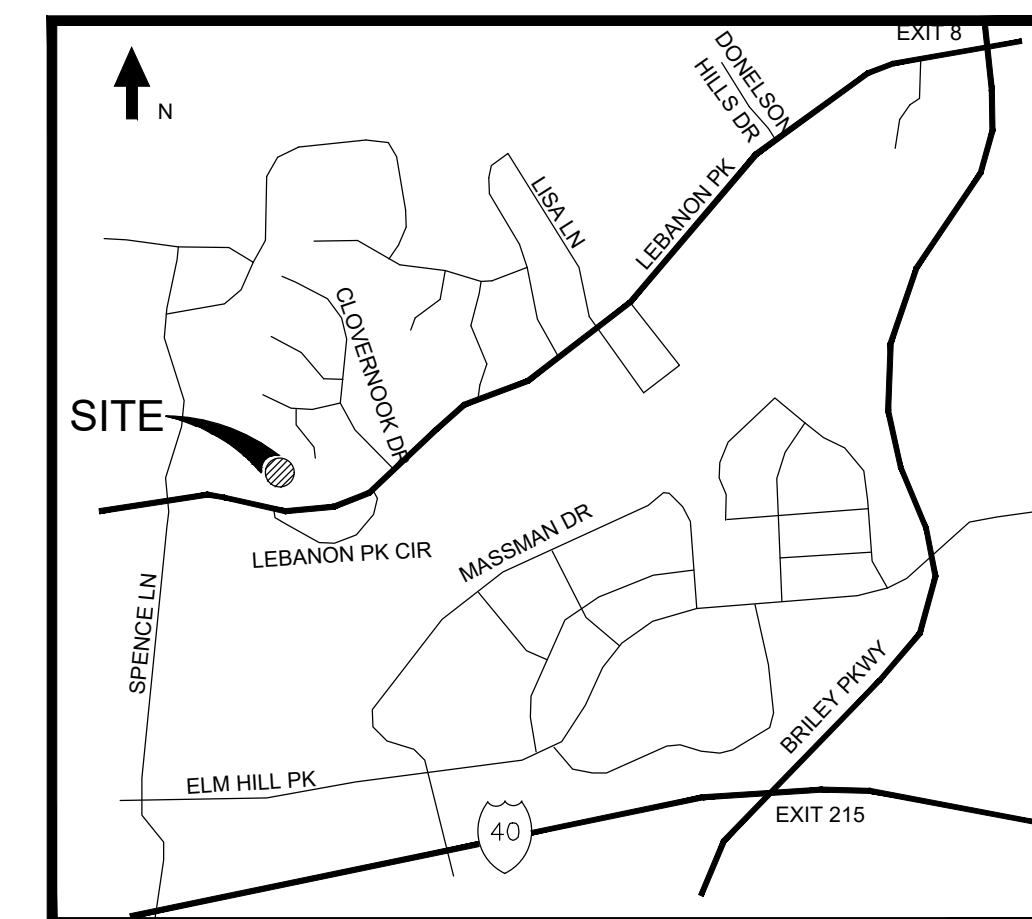

Vicinity Map
NOT TO SCALE

INDEX OF DRAWINGS

SHEET	DESCRIPTION
T1.0	TITLE SHEET
C1.0	EXISTING SITE LAYOUT
C2.0	SITE LAYOUT PLAN
C3.0	GRADING PLAN
C4.0	INITIAL EPSC PLAN
C5.0	PHASE 2 EPSC PLAN
C6.0	FINAL EPSC PLAN
C7.0	EPSC DETAILS
C8.0	UTILITY PLAN
C9.0	BIO-RETENTION DETAILS
C10.0	STANDARD SITE DETAILS
C11.0	STANDARD SITE DETAILS
C12.0	METRO STANDARD DETAILS
C13.0	RETAINING WALL DETAILS

September 6, 2016

Introduced:	September 6, 2016
Passed First Reading:	September 6, 2016
Referred to:	Planning Commission - Approved with conditions and disapproved without all conditions (6-0) Planning, Zoning, & Historical Committee
Public Hearing Scheduled For:	October 4, 2016
Passed Second Reading:	October 4, 2016
Passed Third Reading:	October 18, 2016
Approved:	October 19, 2016
By:	
Effective:	October 21, 2016

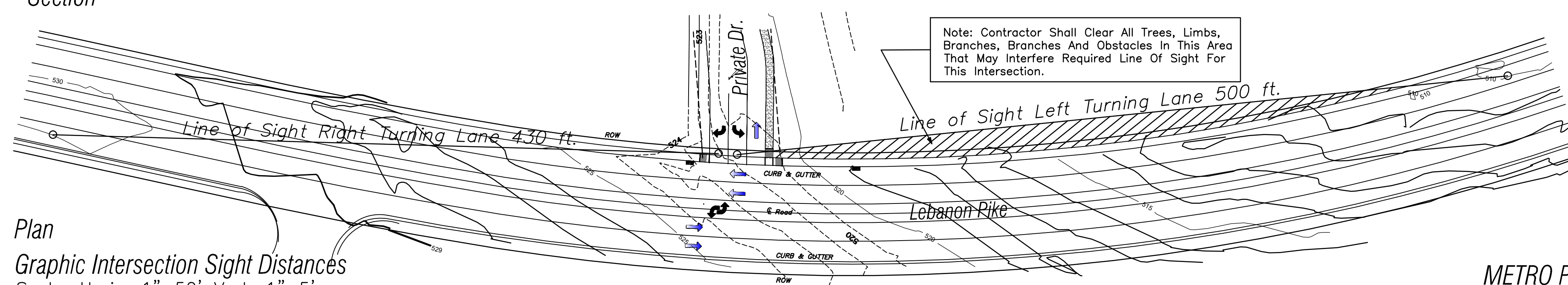
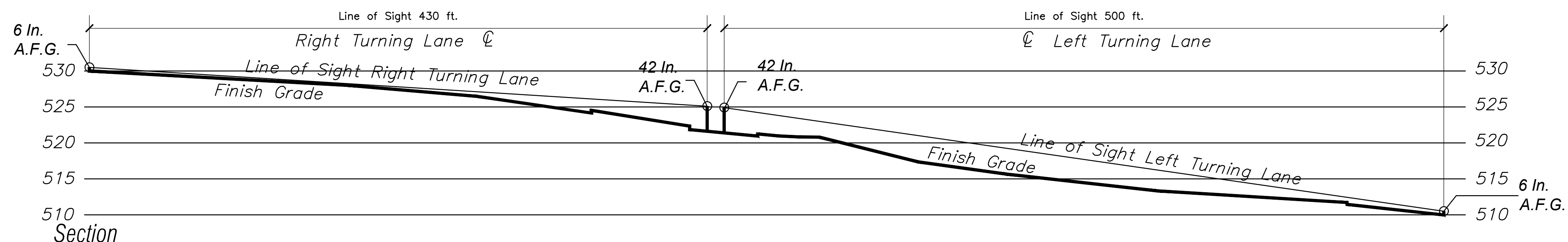

Plan
Graphic Intersection Sight Distances
Scale: Horiz. 1"=50' Vert. 1"=5'

METRO PROJECT 2016SP-29-003

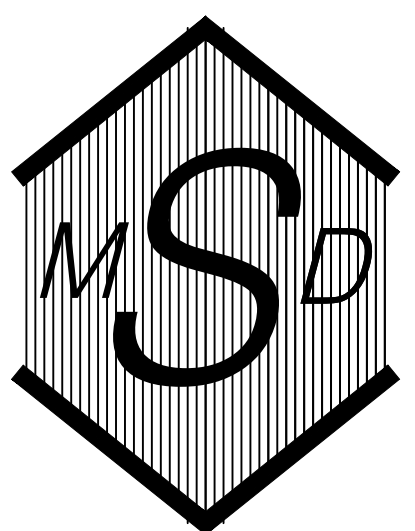

MURRAY D. SHANKLIN, PE
P.O. BOX 9
PORTLAND, TN 37148
615.512.2911
Email: mshanklin@bellsouth.net
mshanklin@bellsouth.net

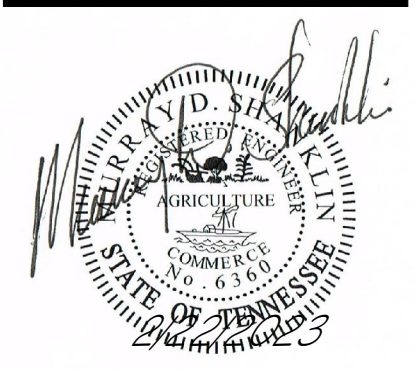

Drawn MDS
Checked By MDS
Project No. 16 ROBERT BERNARD
Date 03/20/2023

Revised 07/15/2019
Revised 09/03/2020
Revised 02/22/2023

A New Multiple Family Home Complex
Apartment Concept
1636 Lebanon Pike
Nashville, Tennessee
Parcel No. 09400005000 and 09400004900

TITLE SHEET

SHEET NO.

T1.0

These plans and specifications and all copies hereof, are the sole and exclusive property of MURRAY D. SHANKLIN, P.E. Any reproduction, publication, exhibition, or use of all or any part hereof without the express written consent of MURRAY D. SHANKLIN, P.E. is strictly prohibited. Anyone viewing these plans is deemed to agree to the above and that MURRAY D. SHANKLIN, P.E. shall be entitled to recover reasonable damages and attorney's fees in any action to enforce the above provisions.

These show only specifications and all copies hereof, are the sole and exclusive property of MURRAY D. SHANKLIN, P.E. Any reproduction, publication, exhibition, or use of all or any part hereof without the express written consent of MURRAY D. SHANKLIN, P.E. is strictly prohibited. Anyone viewing these plans is deemed to agree to the above and that MURRAY D. SHANKLIN, P.E. shall be entitled to recover reasonable damages and attorney's fees in any action to enforce the above provisions.

LEGEND

PARCEL NO.	()
IRON ROD (OLD)	○ IR(O)
CONC MON (OLD)	⊠ MON(O)
IRON ROD (SET)	● IR(IN)
PROPERTY LINE	—
CONTOUR LINE	502
FENCE	—
OVERHEAD POWER LINE	OH
SANITARY SEWER LINE	15"RCP
STORM SEWER LINE	15"RCP
WATER LINE	—
GAS LINE	—
TREE DRIP LINE	—
UTILITY POLE	○
GUY WIRE	—
LIGHT POST	⊙
SANITARY SEWER MANHOLE	⊠
CURB INLET	⊠
CATCH BASIN	⊠
FIRE HYDRANT	⊠
WATER METER	⊠
WATER VALVE	⊠
CONCRETE	⊠

SURVEYOR'S NOTES

1. SURVEYOR'S LIABILITY FOR THE DOCUMENT SHALL BE LIMITED TO THE ORIGINAL PURCHASER AND DOES NOT EXTEND TO ANY UNNAMED PERSON OR ENTITIES WITHOUT AN EXPRESSED RE-CERTIFICATION BY WHOSE SIGNATURE APPEARS UPON THE SURVEY.
2. PARCELS NUMBERS SHOWN AS THUS (00) REFER TO TAX MAP 94, DAVIDSON COUNTY, TENNESSEE.
3. ALL DISTANCES WERE MEASURED WITH E.D.M. EQUIPMENT AND HAVE BEEN ADJUSTED FOR TEMPERATURE.
4. THE PROPERTY DOES NOT LIE WITHIN THE 100 YEAR FLOOD PLAIN AND IS DETERMINED TO BE IN ZONE "X" AS SHOWN ON FEDERAL EMERGENCY MANAGEMENT AGENCY FIRM MAP NUMBER 4703700239 F, DATED APRIL 26, 2001.
5. THIS SURVEYOR WAS NOT PROVIDED WITH A TITLE COMMITMENT, THEREFORE THE PROPERTY IS SUBJECT TO THE FINDINGS OF A DETAILED TITLE SEARCH.
6. PRIOR TO ANY CONSTRUCTION, EXCAVATION OR ANY DISTURBANCE OF THE EXISTING GROUND ELEVATION, THE OWNER AND / OR CONTRACTOR SHOULD ASSUME RESPONSIBILITY OF CONTACTING THE LOCAL UTILITY AUTHORITIES FOR EXACT LOCATION OF UNDERGROUND GAS LINES, TELEPHONE LINES, ELECTRIC CABLES, WATER LINES, ETC. TO AVOID ANY HAZARD OR CONFLICT. IN TENNESSEE, IT IS A REQUIREMENT, PER THE UNDERGROUND UTILITY DAMAGE PREVENTION ACT, THAT ANYONE WHO ENGAGES IN EXCAVATION MUST NOTIFY ALL KNOWN UNDERGROUND UTILITY OWNERS, NO LESS THAN THREE (3) NOR MORE THAN (10) WORKING DAYS PRIOR TO THE DATE OF THEIR EXCAVATION TO AVOID ANY POSSIBLE HAZARD OR CONFLICT. DIAL 811 FOR A ONE CALL CENTER.
7. UTILITIES SHOWN WERE TAKEN FROM FIELD LOCATIONS THAT WERE APPARENT AND COPIED FROM APPROPRIATE GOVERNING AGENCIES MAPS AND ARE APPROXIMATE AT BEST. THERE MAY BE UTILITIES, THE EXISTENCE OF WHICH IS UNKNOWN TO THE SURVEYOR.
8. TOPOGRAPHIC INFORMATION WAS DERIVED BY RANDOM SHOTS PER FIELD SURVEY; CONTOUR INTERVAL IS 1'. DATUM BASED ON NAVD 88.
9. ALL DEED & PLAT REFERENCES ARE MADE TO THE REGISTER'S OFFICE OF DAVIDSON COUNTY, TENNESSEE (RODC).
10. SURVEY FIELD DATA COLLECTED ON 7-23-15.

By graphic plotting only, this property is in Zone(s) "X" of the Flood Insurance Rate Map Community Panel No. 4703700239F which bears an effective revised date of April 5, 2017. No field surveying was performed to determine this zone and an elevation certificate may be needed to verify this determination or apply for a variance from the Federal Emergency Management Agency.

SOURCE OF VERTICAL DATUM

- SITE BM: TAG BOLT ON FIRE HYDRANT NO. 11490 NORTHERN ROW OF LEBANON RD. ELEV: 522.77
- PROJECT BM: NAVD 88 (GPS DERIVED)

UTILITY NOTES AND OWNERS

The utility information shown hereon was taken from actual field evidence, utility agency records, or any other available evidence. Other utilities may exist and may not be shown, or may vary from where shown. No guarantee is expressed or implied in regard to the utility locations shown hereon. The Owner(s) and Contractor(s) shall assume responsibility to verify utility existence, size, location, depth, and availability of service, and be solely responsible for contacting the utility location service prior to commencing construction.

SEWER METRO WATER AND SEWERAGE SERVICES 1600 SECOND AVENUE NORTH NASHVILLE, TN 37208 (615) 862-4505	ELECTRIC NES NASHVILLE ELECTRIC SERVICE 1214 CHURCH STREET NASHVILLE, TN 37203 (615) 747-3641
GAS PIEDMONT NATURAL GAS 665 MAINSTREAM DRIVE NASHVILLE, TN 37228 (704) 364-3120	TELEPHONE AT&T 2501 PARK PLAZA NASHVILLE, TN 37203 (615) 344-5288
CABLE COMCAST 660 MAINSTREAM DRIVE NASHVILLE, TN 37228 (615) 244-0900	

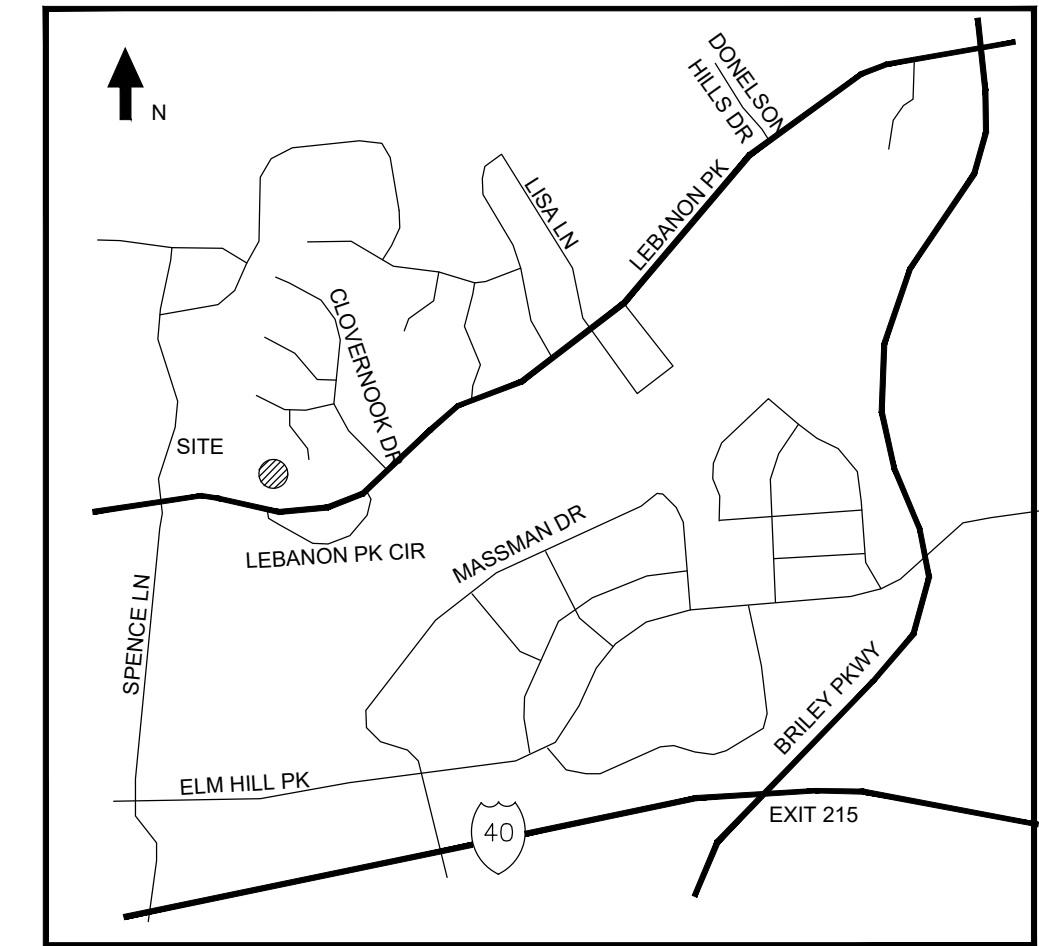
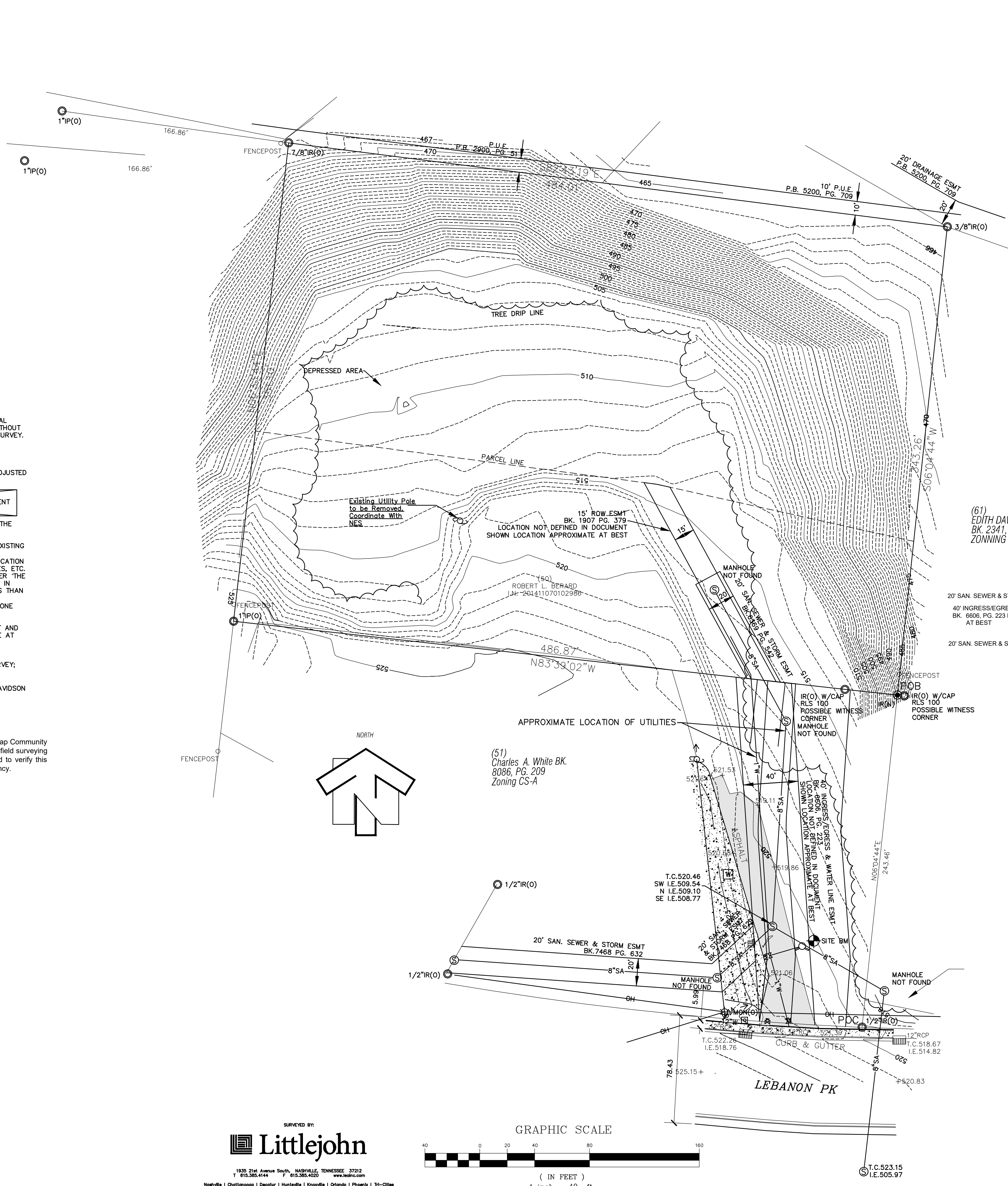
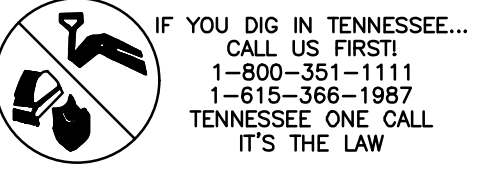

PROPERTY DESCRIPTION

A tract of land in the 15th District, Davidson County, Tennessee. Tract being bounded on the north by Lots 1 and 35 of Clover Nook Subdivision, as recorded in Plat Book 2900, Page 51, Register's Office, Davidson County, Tennessee. (RODC), on the east by the Edith Davidson tract, as recorded in Book 2341, Page 267, RODC, on the south by the Robert L. Beard tract, as recorded in Instrument Number 201411070102986, RODC and on the west by the Bradley W. Whitfield tract, as recorded in Book 10262, Page 762, RODC. Tract being described as follows:

Point of Commencement being a 1/2" iron rod old on the northern Right of Way and being the southeastern corner of the said Robert L. Beard tract. Thence along the common line of the said Robert L. Beard and Edith Davidson tract thence N 06° 04' 44" E 2043.46 feet to an iron rod new and being the POINT OF BEGINNING being thence along the common line of the said Robert L. Beard tract N 83° 30' 02" W 486.87 feet to a 1" iron pipe old; thence along the common line of the said Bradley W. Whitfield tract N 06° 33' 44" E 351.10 feet to a 7/8" iron rod old; thence along the common line of the said Clover Nook Subdivision S 82° 43' 19" E 484.01 feet to a 3/8" iron rod old; thence along the common line of the said Edith Davidson tract S 06° 04' 44" W 343.26 feet to the point of beginning.

Tract contains 168,520 square feet or 3.87 acres.
Bearings based on Tennessee State Plane Coordinate System.

SURVEYOR'S CERTIFICATE

I hereby certify that to the best of my knowledge and belief the hereon shown Boundary & Topographic Survey represents a Category "T" survey having an unadjusted ratio of precision greater than 1:10,000 and is true and correct.

By: ROBERT M. SEARSON TN REGISTERED SURVEYOR'S No. 1666 Date: _____

SITE DATA

PROPERTY LOCATED ON DAVIDSON COUNTY TAX MAP MAP 94, PARCELS 49 & 50, PORTION OF 51

CITY: NASHVILLE
COUNTY: DAVIDSON
STATE: TN
DISTRICT: 15

SITE ADDRESS: 1936 LEBANON PIKE
NASHVILLE, TN 37210

OWNER: PARCELS 49 & 50
ROBERT L. BERARD
334 RAYMOND HODGES RD
COTTONTOWN, TN 37048
I.N. 201411070102986

PARCEL 51
CHARLES A. WHITE
1622 LEBANON PK
NASHVILLE, TN 37210
BK. 8086, PG. 209

FLOOD NOTE

By graphic plotting only, this property is in Zone(s) "X" of the Flood Insurance Rate Map Community Panel No. 4703700239F which bears an effective revised date of April 5, 2017. No field surveying was performed to determine this zone and an elevation certificate may be needed to verify this determination or apply for a variance from the Federal Emergency Management Agency.

PROPERTY MAP REFERENCE

This property currently identified as Parcels 49.00 and 50.00 on Tax Map No. 094-00.

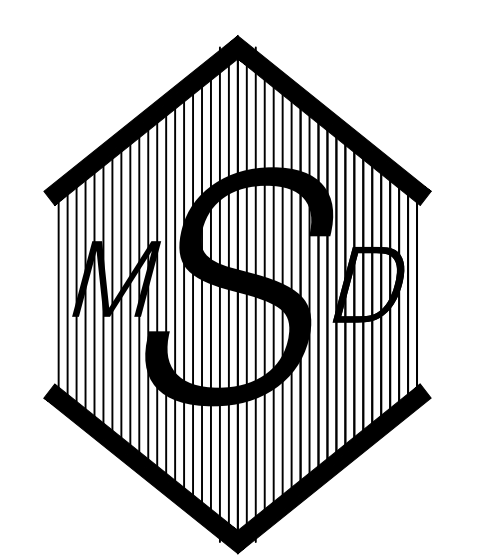
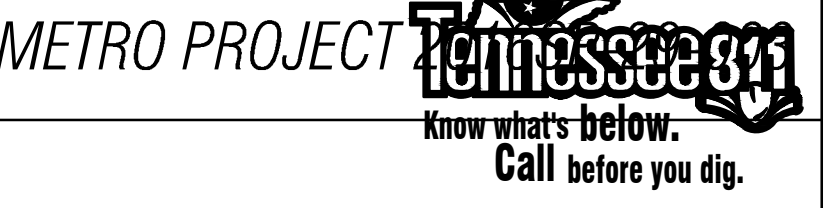
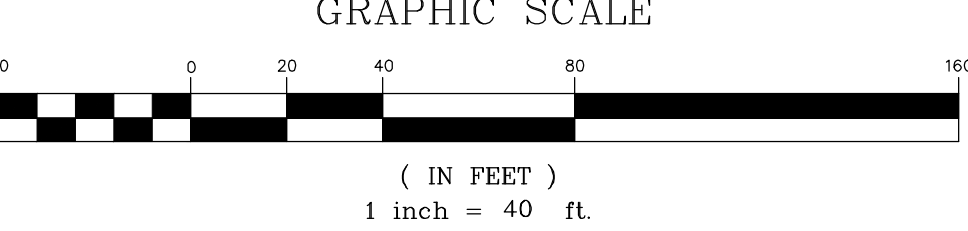

MURRAY D. SHANKLIN, PE
P.O. BOX 9
PORTLAND, TN 37148
615.512.2911
Email: mshanklin@bellsouth.net



Drawn	MDS
Checked By	MDS
Project No.	16 ROBERT BERARD
Date	07/15/2019

Revised 06/21/2016
Revised 07/03/2016
Revised 03/06/2019
Revised 07/15/2019
Revised 08/03/2020

A New Multiply Family Home Complex
Apartment Concept
1636 Lebanon Pike
Nashville, Tennessee
Parcel No. 09400005000 and 09400004900

SHEET TITLE:

Existing Site Layout

SHEET NO.

C1.0

These plans and specifications and all copies hereof, are the sole and exclusive property of MURPHY D. SHANKLIN, P.E. Any reproduction, publication, exhibition, or use of all or any part hereof without the express written consent of MURPHY D. SHANKLIN, P.E. is strictly prohibited. Anyone viewing these plans is deemed to agree to the above and that MURPHY D. SHANKLIN, P.E. shall be entitled to recover reasonable damages and attorney's fees in any action to enforce the above provisions.

LEGEND	
PARCEL NO.	()
IRON ROD (OLD)	○ IR(O)
CONC MON (OLD)	⊠ MON(O)
IRON ROD (SET)	● IR(N)
PROPERTY LINE	---
CONTOUR LINE	502
FENCE	---
OVERHEAD POWER LINE	OH
SANITARY SEWER LINE	---
STORM SEWER LINE	15"RCP
WATER LINE	---
GAS LINE	---
TREE DRIP LINE	---
UTILITY POLE	○
GUY WIRE	↑
LIGHT POST	⊙
SANITARY SEWER MANHOLE	⊙
CURB INLET	⊠
CATCH BASIN	⊠
FIRE HYDRANT	⊠
WATER METER	⊠
WATER VALVE	⊠
CONCRETE	⊠

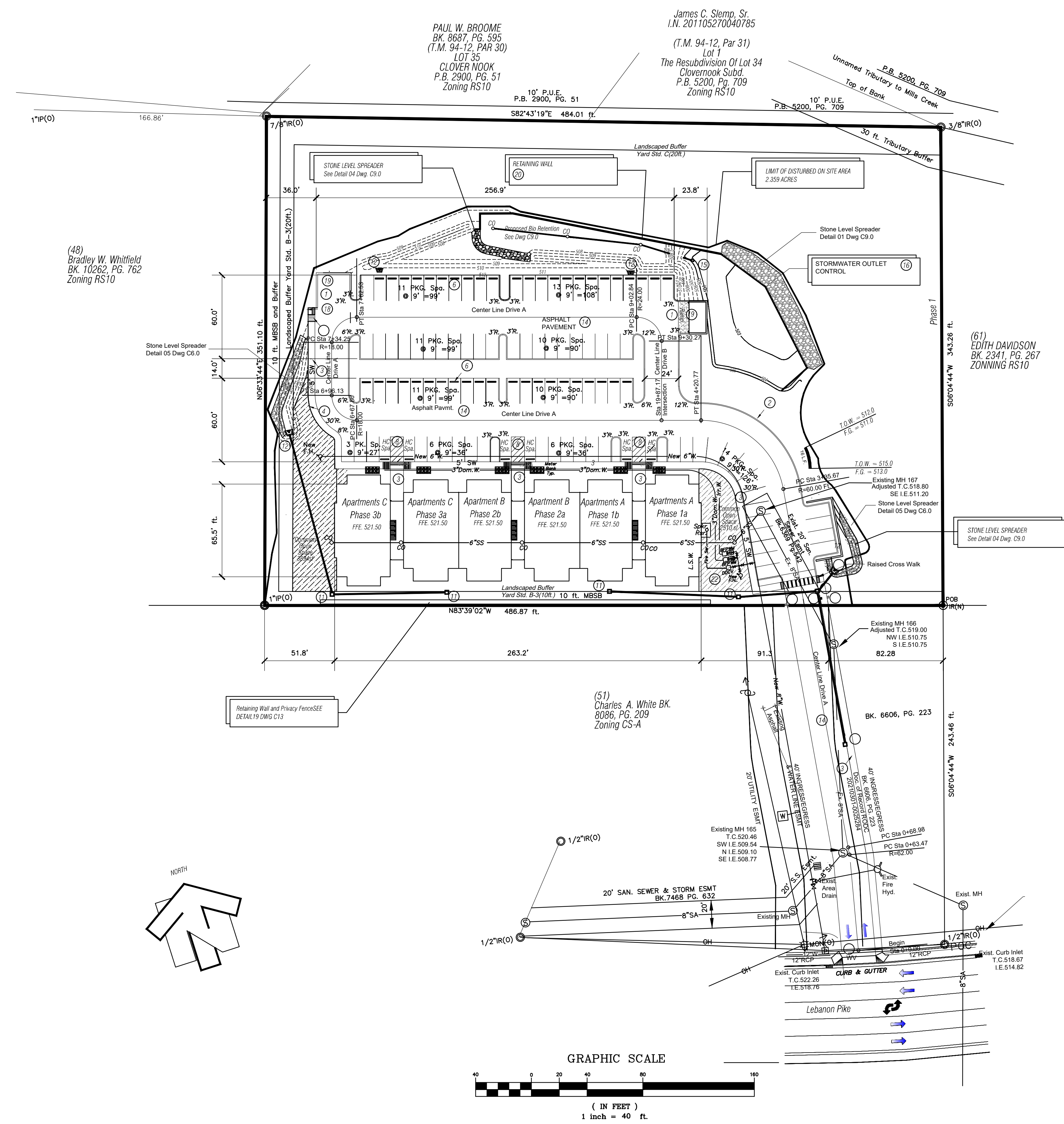
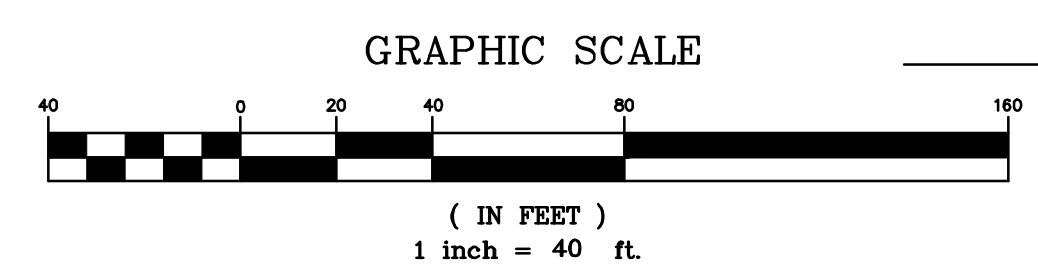
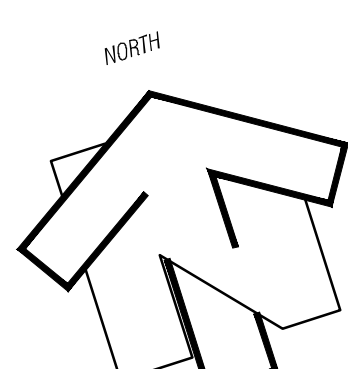

SITE DATA TABLE						
SOURCE OF INFORMATION: Metro Nashville Planning Department						
NAME OF CONTACT: Executive Director						
ADDRESS: 800 2nd Avenue South P.O. Box 196300 Nashville, TN 37219-6300						
PHONE: (615) 862-7150 FAX: (615) 862-7130 WEBSITE: www.nashville.gov/mpc						
ZONING DISTRICT(S): SP (Fall Back Zoning RM15-A)						
ZONING DEFINITION: Specific Plan District						
Building Setback Requirements						
	Observed	Required	Notes			
FRONT YARD SETBACK	75'	65'	(U6) Street Classification			
SIDE YARD SETBACK	-	0'				
REAR YARD SETBACK	91'	20'				
Building Height Requirements						
APARTMENTS	Maximum Eave Height 43 ft.	4 Stories.				
	Maximum Overall Height 35 ft.					
Parking Tabulation						
	Observed	Required	Notes			
REGULAR SPACES	65	64	2.0 PER 2 B.R. APT.			
2 BEDROOM APTS.	40	40	2.5 PER 3 B.R. APT.			
3 BEDROOM APTS.	105	104				
TOTAL PARKING SPACES						
HANDICAP PARKING: INCLUDED IN THE TOTAL PARKING 6 HC SPACES ARE PROVIDED						
Bulk Restrictions						
	Observed	Required	Notes			
MINIMUM LOT AREA	168.520 SQ. FT.	NONE				
MINIMUM LOT WIDTH	PER SP	PER SP				
MAXIMUM HEIGHT	PER SP	PER SP				
LOT AREA	3.87 ac.	3.87 ac.				
FAR	41.11%	60% MAX.				
DENSITY UNITS/ACRE	12.37					
ISR	36.97%	90% MAX.				
Building Data						
BUILDING CONSTRUCTION PHASE						
	1a	1b	2a	2b	3a	3a
	NO. UNITS	NO. UNITS	NO. UNITS	NO. UNITS	NO. UNITS	NO. UNITS
2 BEDROOM APTS.		8	8	8	8	
3 BEDROOM APTS.		8	8	8	8	
TOTAL NUMBER APARTMENT UNITS						48
BUILDING AREA						
BUILDING FOOTPRINT AREA:	17,314 SF					
BUILDING AREA TOTAL 4 FLOORS:	69,256 SF					

BUILDING DATA						
BUILDING CONSTRUCTION PHASE						
	1a	1b	2a	2b	3a	3a
	NO. UNITS	NO. UNITS	NO. UNITS	NO. UNITS	NO. UNITS	NO. UNITS
2 BEDROOM APTS.		8	8	8	8	
3 BEDROOM APTS.		8	8	8	8	
TOTAL NUMBER APARTMENT UNITS						48
BUILDING AREA						
BUILDING FOOTPRINT AREA:	17,314 SF					
BUILDING AREA TOTAL 4 FLOORS:	69,256 SF					

Bulk Restrictions			
	Observed	Required	Notes
MINIMUM LOT AREA	168.520 SQ. FT.	NONE	
MINIMUM LOT WIDTH	PER SP	PER SP	
MAXIMUM HEIGHT	PER SP	PER SP	
LOT AREA	3.87 ac.	3.87 ac.	
FAR	41.11%	60% MAX.	
DENSITY UNITS/ACRE	12.37		
ISR	36.97%	90% MAX.	

BUILDING DATA						
BUILDING CONSTRUCTION PHASE						
	1a	1b	2a	2b	3a	3a
	NO. UNITS	NO. UNITS	NO. UNITS	NO. UNITS	NO. UNITS	NO. UNITS
2 BEDROOM APTS.		8	8	8	8	
3 BEDROOM APTS.		8	8	8	8	
TOTAL NUMBER APARTMENT UNITS						48
BUILDING AREA						
BUILDING FOOTPRINT AREA:	17,314 SF					
BUILDING AREA TOTAL 4 FLOORS:	69,256 SF					

By graphic plotting only, this property is in Zone(s) "X" of the Flood Insurance Rate Map Community Panel No. 47037C0264H which bears an effective revised date of April 5, 2017. No field surveying was performed to determine this zone and an elevation certificate may be needed to verify this determination or apply for a variance from the Federal Emergency Management Agency.

- KEY NOTES ○
- | | |
|---|--------------------------|
| 1 - TYP. CONCRETE RAMP | SEE DETAIL 01, SHT C10.0 |
| 2 - TYPICAL CURB DETAIL | SEE DETAIL 02, SHT C10.0 |
| 3 - CONC. WALK W/ TURNDOWN | SEE DETAIL 03, SHT C10.0 |
| 4 - CONC. WALK W/HANDRAIL | SEE DETAIL 04, SHT C10.0 |
| 5 - METAL HANDRAIL | SEE DETAIL 05, SHT C10.0 |
| 6 - CONCRETE WHEEL STOP | SEE DETAIL 06, SHT C10.0 |
| 7 - DRIVEWAY ENTRANCE DETAILS | SEE DETAIL 01, SHT C12.0 |
| 8 - SITE HANDICAP DETAILS | SEE DETAIL 08, SHT C10.0 |
| 9 - JUNCTION BOX | SEE DETAIL 09, SHT C10.0 |
| 10 - CURB DRAIN | SEE DETAIL 10, SHT C10.0 |
| 11 - AREA DRAIN | SEE DETAIL 11, SHT C10.0 |
| 12 - CONCRETE HEADWALL (PRECAST) | SEE DETAIL 12, SHT C10.0 |
| 13 - CONCRETE DITCH SECTION | SEE DETAIL 13, SHT C10.0 |
| 14 - PAVEMENT SECTION DETAIL | SEE DETAIL 14, SHT C10.0 |
| 15 - OUTLET PIPE PROTECTION | SEE DETAIL 15, SHT C10.0 |
| 16 - STORMWATER OUTLET CONTROL | SEE DETAIL 01, SHT C9.0 |
| 17 - ROOF DRAIN WITH CLEAN OUT DETAIL | SEE DETAIL 17, SHT C10.0 |
| 18 - DETECTABLE WARNING SURFACE | SEE DETAIL 18, SHT C10.0 |
| 19 - DUMPSTER STORAGE AREA PLAN | SEE DETAIL 19, SHT C11.0 |
| 20 - RETAINING WALL | SEE DETAIL 01, SHT C9.0 |
| 21 - RETAINING WALL | SEE DETAIL 01, SHT C9.0 |
| 22 - GROUND MOUNTED ELECTRICAL TRANSFORMER | INSTALLED BY NES. |
| 23 - GATE POST (PROVIDE KNOX BOX AS APPROVED SEE DETAIL 01, SHT C9.0) | |

THE UTILITIES SHOWN HEREON ARE BASED ON FIELD OBSERVATIONS AND INFORMATION OBTAINED FOR THE UTILITY DISTRICT. PRIOR TO ANY EXCAVATION THE EXACT LOCATION OF THE UNDERGROUND UTILITIES SHOULD BE DETERMINED. TENNESSEE ONE-CALL 1-800-351-1111.

IT IS THE CONTRACTOR'S RESPONSIBILITY TO CONTACT UTILITY COMPANIES PRIOR TO ANY CONSTRUCTION. THE LOCATION OF UTILITIES SHOWN ON THESE PLANS ARE APPROXIMATE AND POSSIBLY INCOMPLETE. THEREFORE CERTIFICATION TO THE LOCATION OF ALL UNDERGROUND UTILITIES IS WITHHELD.

CONSTRUCTION SCHEDULE						
	JUN	JUL	AUG	SEP	OCT	NOV
TEMPORARY SEDEMENT STRUCTURES	[Bar chart showing duration from June to November]					
SEDIMENT BASIN	[Bar chart showing duration from June to November]					
DIVERSION DITCHES	[Bar chart showing duration from June to November]					
TEMPORARY VEGETATION	[Bar chart showing duration from June to November]					
CLEARING AND GRUBBING	[Bar chart showing duration from June to November]					
TOP SOIL STRIPPING AND STORAGE	[Bar chart showing duration from June to November]					
BUILDING PAD AND DRIVEWAY BASE	[Bar chart showing duration from June to November]					
INTERMEDIATE AND PERMANENT VEGETATION	[Bar chart showing duration from June to November]					

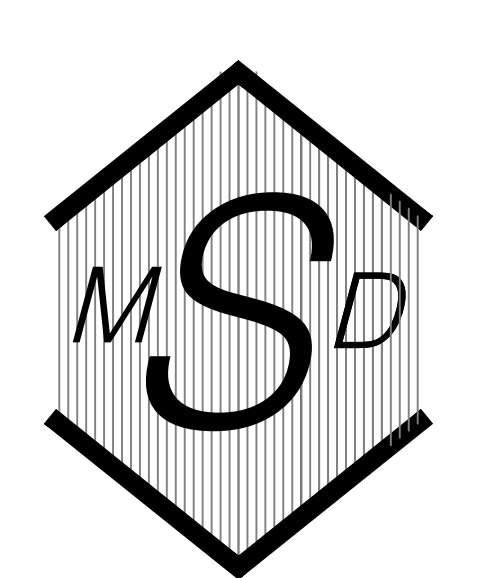

MURRAY D. SHANKLIN, PE
P.O. BOX 9
PORTLAND, TN 37148
615.512.2911
Email: mshanklin@bellsouth.net

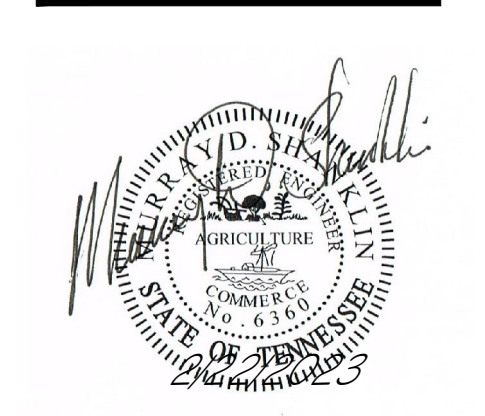

Draw: MDS
Checked By: MDS
Project No.: 16 ROBERT BERARD
Date: 07/15/2019

Revised 06/21/2016
Revised 07/03/2016
Revised 03/08/2019
Revised 07/15/2019
Revised 08/03/2020
Revised 10/02/2020
Revised 11/03/2023

A New Multiply Family Home Complex
Apartment Concept
1636 Lebanon Pike
Nashville, Tennessee
Parcel No. 09400005000 and 09400004900

SHEET TITLE:
Site Layout Plan

SHEET NO.
C2.0

SITE LAYOUT NOTES

TOPOGRAPHICAL INFORMATION SHOWN HEREON WAS PROVIDED BY LITTLEJOHN, 1935 21ST AVENUE SOUTH, NASHVILLE, TENNESSEE 615-385-4144.

BY GRAPHIC PLOTTING ONLY, THIS PROPERTY IS IN ZONE(S) "X" OF THE FLOOD INSURANCE RATE MAP COMMUNITY PANEL NO. 47037C0264H WHICH BEARS AN EFFECTIVE REVISED DATE OF APRIL 5, 2017. NO FIELD SURVEYING WAS PERFORMED TO DETERMINE THIS ZONE AND AN ELEVATION CERTIFICATE MAY BE NEEDED TO VERIFY THIS DETERMINATION OR APPLY FOR A VARIANCE FROM THE FEDERAL EMERGENCY MANAGEMENT AGENCY.

THE UTILITY INFORMATION SHOWN HEREON WAS TAKEN FROM ACTUAL FIELD EVIDENCE, UTILITY AGENCY RECORDS, OR ANY OTHER AVAILABLE EVIDENCE. OTHER UTILITIES MAY EXIST AND MAY NOT BE SHOWN, OR MAY VARY FROM WHERE SHOWN. NO GUARANTEE IS EXPRESSED OR IMPLIED IN REGARD TO THE UTILITY LOCATIONS SHOWN HEREON. THE OWNER(S) AND CONTRACTOR(S) SHOULD ASSUME RESPONSIBILITY TO VERIFY UTILITY EXISTENCE, SIZE, LOCATION, DEPTH, AND AVAILABILITY OF SERVICE, AND BE SOLELY RESPONSIBLE FOR CONTACTING THE UTILITY LOCATION SERVICE PRIOR TO COMMENCING CONSTRUCTION.

PRIOR TO CONSTRUCTION, EXCAVATION, OR DISTURBANCE OF THE EXISTING GROUND ELEVATION, THE CONTRACTOR SHALL ASSUME THE RESPONSIBILITY AND EXPENSE OF CONTACTING THE LOCAL UTILITY OWNERS AND DEFINITELY ESTABLISHING THE EXISTENCE, EXACT LOCATIONS AND SIZES OF UNDERGROUND UTILITIES TO AVOID ANY HAZARD OR CONFLICT.

TENNESSEE LAW REQUIRES NO LESS THAN THREE NOR MORE THAN TEN WORKING DAYS NOTICE TO UNDERGROUND UTILITY OWNERS PRIOR TO INTENT TO EXCAVATE. A LIST OF THESE UTILITIES MAY BE OBTAINED FROM EACH COUNTY'S REGISTER OF DEEDS. THOSE UTILITIES THAT PARTICIPATE IN THE TN ONE-CALL SYSTEM CAN BE NOTIFIED AT 1-800-351-1111.

CONTRACTOR IS TO PROTECT UTILITIES THAT ARE TO REMAIN AND ALL EXISTING IMPROVEMENTS INCLUDING BUT NOT LIMITED TO STRUCTURES, PAVEMENT, RAMPS, TREES, SIDEWALKS, CULVERTS, ETC. CONTRACTOR SHALL REPAIR ANY DAMAGE TO EXISTING IMPROVEMENTS AND UTILITIES TO REMAIN ACCORDING TO LOCAL STANDARDS AND AT THE CONTRACTOR'S EXPENSE. CONTRACTOR IS TO COORDINATE ALL CONSTRUCTION WITH THE APPROPRIATE UTILITY AUTHORITIES.

THE CONTRACTOR SHALL CONFORM TO ALL LOCAL CODES AND RECEIVE APPROVAL WHERE NECESSARY BEFORE DEMOLITION OR CONSTRUCTION.

ALL FEES, LICENSES, AND PERMITS NECESSARY FOR THE CONSTRUCTION OF THIS PROJECT ARE TO BE OBTAINED BY THE CONTRACTOR PRIOR TO THE INITIATION OF CONSTRUCTION AND THE COST OF SAME TO BE BORNE BY THE CONTRACTOR.

THE CONTRACTOR SHALL VERIFY ALL DIMENSIONS BEFORE PROCEEDING WITH THE WORK. ANY DISCREPANCIES SHALL BE RESOLVED PRIOR TO CONSTRUCTION.

IN THE EVENT OF ANY DISCREPANCIES AND/OR ERRORS FOUND IN THE DRAWINGS OR IF PROBLEMS ARE ENCOUNTERED DURING CONSTRUCTION, THE CONTRACTOR IS REQUIRED TO CONTACT THE ENGINEER BEFORE PROCEEDING WITH THE WORK.

ALL ACCESSIBLE ROUTES SHALL COMPLY WITH ADA GUIDELINES.

EXISTING AND PROPOSED CONTOURS SHOWN ARE AT 1 FOOT INTERVALS. SPOT ELEVATIONS ARE SHOWN IN CRITICAL AREAS. ALL GRADES SHOWN ARE FINISHED GRADES. THE CONTRACTOR SHALL INSURE POSITIVE DRAINAGE. NO STANDING WATER SHALL OCCUR ANYWHERE ON THE SITE.

THE CONTRACTOR SHALL PROVIDE A ROCK EXCAVATION PRICE IN THE CASE ROCK IS ENCOUNTERED ON THE SITE.

As Built Note

In accordance with the Metro Stormwater Management Manual, Volume Section 3.9, As-Built Certification, MWS Stormwater Division must approve the following as built prior to issuance of the Use & Occupancy Permit:

- Underground detention and water quality infrastructure
- Above ground detention and water quality infrastructure
- Public storm sewer infrastructure
- Cut and fill in the floodplain
- Sink hole alterations

The Engineer shall contact Stormwater Development Review staff for submittal requirements

SCHEDULE OF DRAINAGE STRUCTURE

MARK	DISCRIPTION	TOP OF CASTING ELEV.	INVERT ELEV. In	INVERT ELEV. Out	Slope (%)	Pipe Size	
1	Headwall			513.85			See Det. 12 Dwg. C10.0
2	Curb Drain	519.00	514.47	514.47	1.00	21"x18" CMP	See Det. 10 Dwg. C10.0
3	Curb Drain	519.50	515.48	515.48	1.00	15"x10' CMP	See Det. 11 Dwg. C10.0
4	Area Drain	519.50	516.08	516.08	1.00	15"x60' CMP	See Det. 11 Dwg. C10.0
5	Area Drain	519.00		517.00		15"x92' CMP	See Det. 11 Dwg. C10.0
6	Headwall			509.00			See Det. 12 Dwg. C10.0
7	Area Drain	519.50	516.20	516.20	6.01	18"x107' CMP	See Det. 11 Dwg. C10.0
8	Area Drain	519.50	517.00	517.00	1.00	15"x55' CMP	See Det. 11 Dwg. C10.0
9	Headwall	519.00		509.00			See Det. 15 Dwg. C10.0
10	Junction Box	520.00	517.00	517.00	2.00	8" PVC	See Det. 09 Dwg. C10.0
13	Headwall			509.00			See Det. 12 Dwg. C10.0
11	Junction Box	520.00	517.00	517.00	2.00	8" PVC	See Det. 09 Dwg. C10.0
14	Headwall			509.00			See Det. 12 Dwg. C10.0
12	Outlet Control Structure			502.00	3.00	6" PVC	See Det. 20 Dwg. C11.0

LEGEND

PARCEL NO.	()
IRON ROD (OLD)	○ IR(O)
CONC MON (OLD)	⊠ MON(O)
IRON ROD (SET)	● IR(N)
PROPERTY LINE	—
CONTOUR LINE	~ 502
FENCE	—
OVERHEAD POWER LINE	OH
SANITARY SEWER LINE	15"RCP
STORM SEWER LINE	—
WATER LINE	—
GAS LINE	—
TREE DRIP LINE	~
UTILITY POLE	⊕
GUY WIRE	←
LIGHT POST	⊙
SANITARY SEWER MANHOLE	⊙
CURB INLET	⊞
CATCH BASIN	⊞
FIRE HYDRANT	⊞
WATER METER	⊞
WATER VALVE	⊞
CONCRETE	⊞

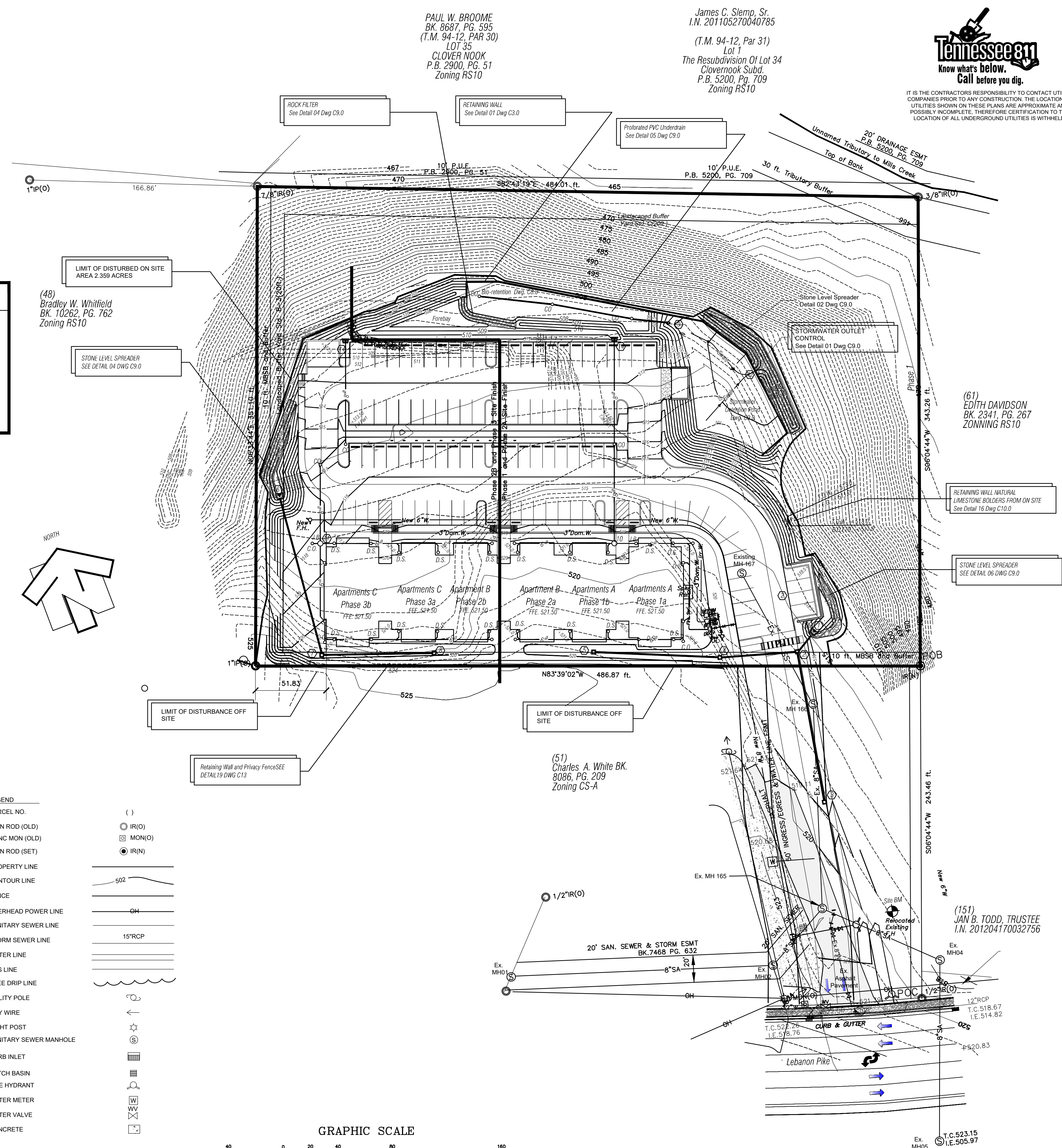
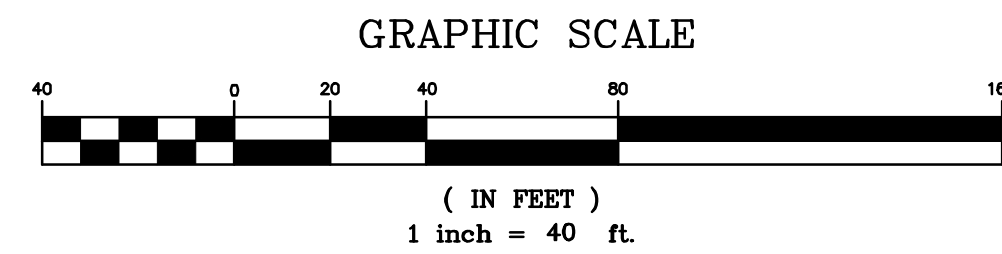

PAUL W. BROOME
BK. 8687, PG. 595
(T.M. 94-12, PAR 30)
LOT 35
CLOVER WOOK
P.B. 2900, PG. 51
Zoning RS10

James C. Stemp, Sr.
I.N. 201105270040785
(T.M. 94-12, Par 31)
Lot 1
The Resubdivision Of Lot 34
Clovernook Subd.
P.B. 5200, Pg. 709
Zoning RS10



IT IS THE CONTRACTOR'S RESPONSIBILITY TO CONTACT UTILITY COMPANIES PRIOR TO ANY CONSTRUCTION. THE LOCATION OF UTILITIES SHOWN ON THESE PLANS ARE APPROXIMATE AND POSSIBLY INCOMPLETE. THEREFORE CERTIFICATION TO THE LOCATION OF ALL UNDERGROUND UTILITIES IS WITHHELD.

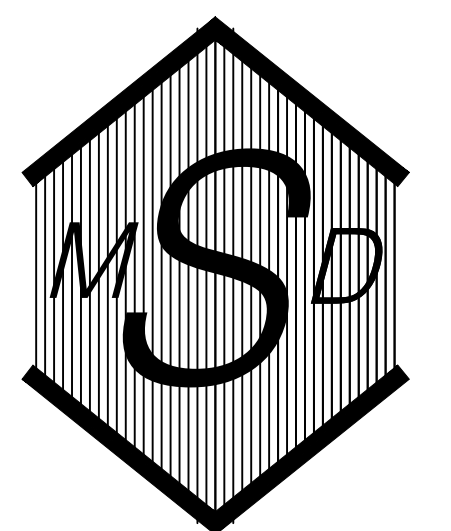

MURRAY D. SHANKLIN, PE
P.O. BOX 9
PORTLAND, TN 37148
615.512.2911
Email: mshanklin@ellsouth.net



Draw: MDS
Checked by: MDS
Project No.:
Date: 07/15/2019

Revised 03/08/2019
Revised 07/15/2019

A New Multiply Family Home Complex
Apartment Concept
1636 Lebanon Pike
Nashville, Tennessee
P.I.

SHEET TITLE:

Grading Plan

SHEET NO.

C3.0

These plans and specifications and all copies hereof, are the sole and exclusive property of MURRAY D. SHANKLIN, PE. Any reproduction, publication, exhibition, or use of all or any part thereof without the express written consent of MURRAY D. SHANKLIN, PE. is strictly prohibited. Anyone violating these plans is deemed to agree to the above and that MURRAY D. SHANKLIN, PE. shall be entitled to recover reasonable damages and attorney's fees in any action to enforce the above provisions.

These plans and specifications and all copies hereof, are the sole and exclusive property of MURRAY D. SHANKLIN, P.E. Any reproduction, publication, exhibition, or use of all or any part hereof without the express written consent of MURRAY D. SHANKLIN, P.E. is strictly prohibited. Anyone viewing these plans is deemed to agree to the above and that MURRAY D. SHANKLIN, P.E. shall be entitled to recover reasonable damages and attorney's fees in any action to enforce the above provisions.

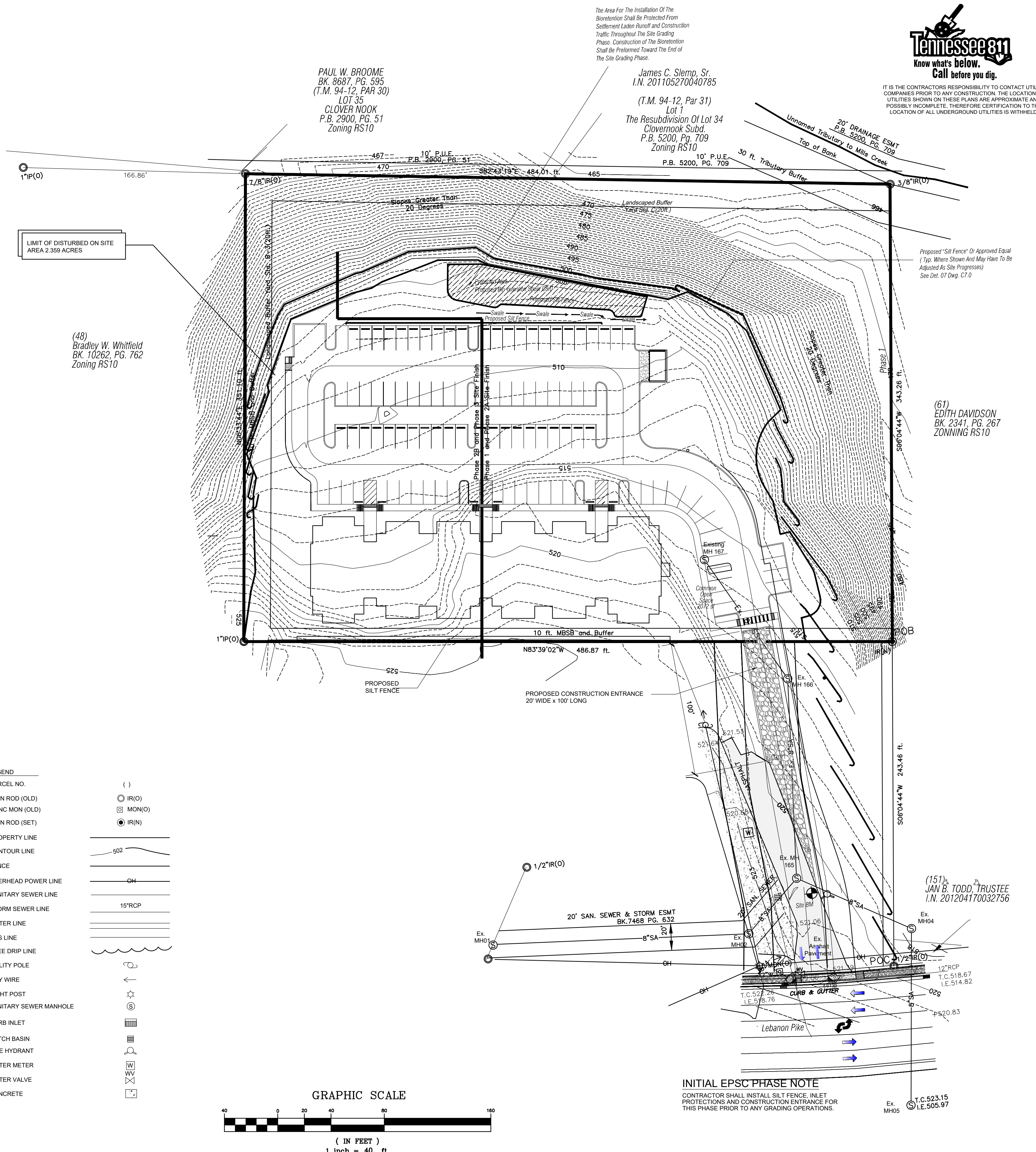
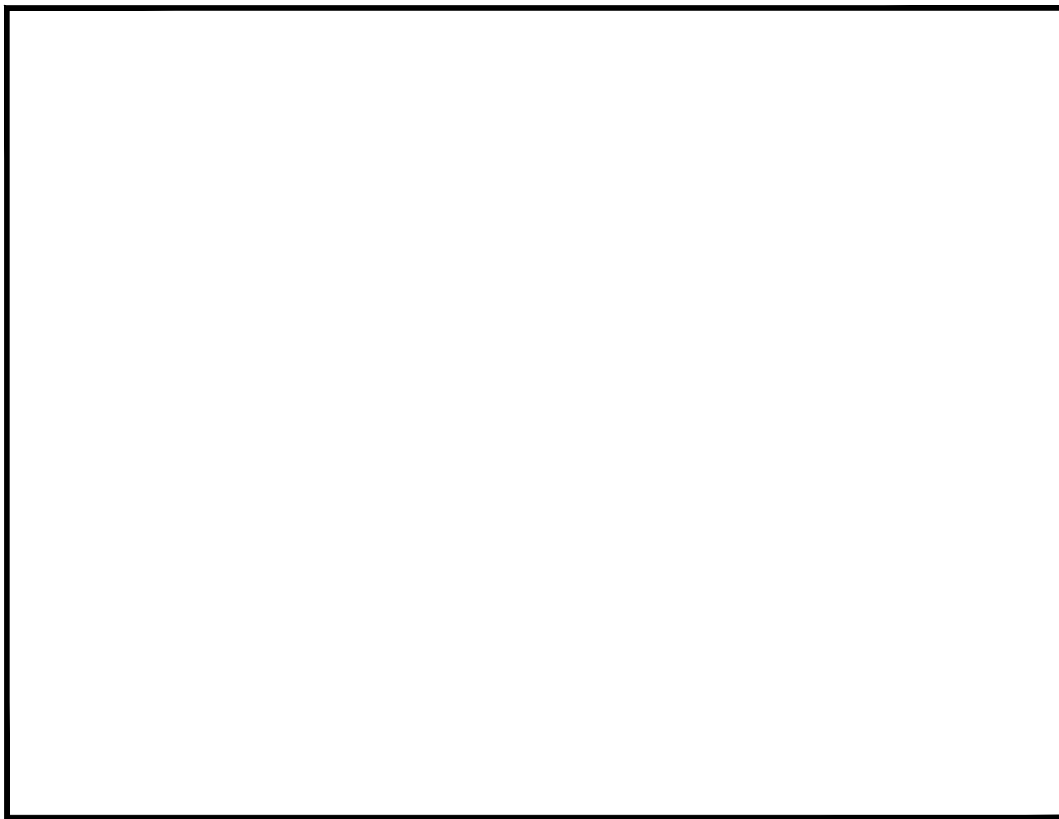

LEGEND

PARCEL NO.	()
IRON ROD (OLD)	○ IR(O)
CONC MON (OLD)	□ MON(O)
IRON ROD (SET)	● IR(N)
PROPERTY LINE	—
CONTOUR LINE	502
FENCE	—
OVERHEAD POWER LINE	OH
SANITARY SEWER LINE	—
STORM SEWER LINE	15"RCP
WATER LINE	—
GAS LINE	—
TREE DRIP LINE	—
UTILITY POLE	○
GUY WIRE	↑
LIGHT POST	☆
SANITARY SEWER MANHOLE	⊙
CURB INLET	▣
CATCH BASIN	▣
FIRE HYDRANT	⊕
WATER METER	⊕
WATER VALVE	⊕
CONCRETE	▣

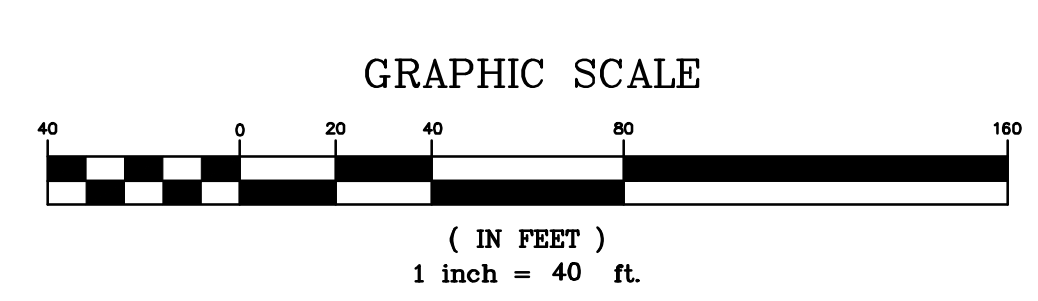

INITIAL EPSC PHASE NOTE
 CONTRACTOR SHALL INSTALL SILT FENCE, INLET PROTECTIONS AND CONSTRUCTION ENTRANCE FOR THIS PHASE PRIOR TO ANY GRADING OPERATIONS.

The Area For The Installation Of The Bioretention Shall Be Protected From Settlement Laden Runoff and Construction Traffic Throughout The Site Grading Phase. Construction Of The Bioretention Shall Be Preferred Toward The End Of The Site Grading Phase.

PAUL W. BROOME
 BK. 8687, PG. 595
 (T.M. 94-12, PAR 30)
 LOT 35
 CLOVER WOOD
 P.B. 2900, PG. 51
 Zoning RS10

James C. Stemp, Sr.
 I.N. 201105270040785
 (T.M. 94-12, Par 31)
 Lot 1
 The Resubdivision Of Lot 34
 Cloverbrook Subd.
 P.B. 5200, Pg. 709
 Zoning RS10

10' P.U.E. P.B. 2900, PG. 51
 10' P.U.E. P.B. 5200, PG. 709

20' DRAINAGE ESMT P.B. 5200, PG. 709
 30 ft. Tributary Buffer
 Unnamed Tributary to Mills Creek
 Top of Bank

Proposed "Silt Fence" Or Approved Equal (Typ. Where Shown And May Have To Be Adjusted As Site Progresses) See Det. 07 Dwg. C7.0

(48) Bradley W. Whitfield
 BK. 10262, PG. 762
 Zoning RS10

(61) EDITH DAVIDSON
 BK. 2341, PG. 267
 ZONING RS10

(151) JAN B. TODD TRUSTEE
 I.N. 201204170032756



M.S.D.

MURRAY D. SHANKLIN, PE
 P.O. BOX 9
 PORTLAND, TN 37148
 615.512.2911
 Email: mshanklin@velisouth.net

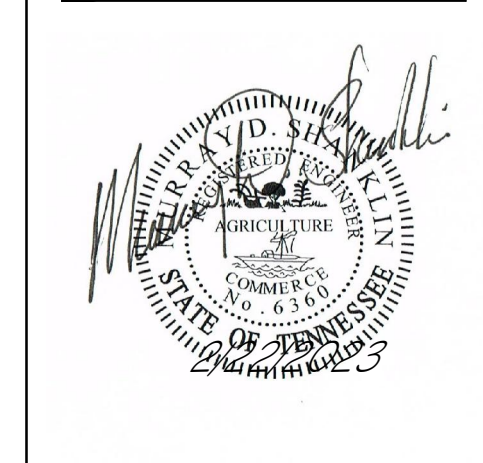

Drawn	MDS
Checked By	MDS
Project No.	16 ROBERT BERARD
Date	
Revised	06/21/2016
Revised	07/03/2016
Revised	03/08/2019
Revised	07/15/2019

A New Multiply Family Home Complex
Apartment Concept
 1636 Lebanon Pike
 Nashville, Tennessee
 Parcel No. 09400005000 and 09400004900

SHEET TITLE:
Initial EPSC Plan

SHEET NO.

C4.0

Erosion, Sediment And Pollution Control Notes

Erosion Control Work Performed By The Contractor Shall Conform To The Stormwater Permitting Requirements Of The Tennessee Department Of Environment And Conservation, Division Of Water Pollution Control, And The "Tennessee Erosion And Sediment Control Handbook" Latest Edition.

The Escape Of Sediment From The Site Shall Be Prevented By The Installation Of Erosion Control Measures And Practices Prior To Or Concurrent With Land-Disturbing Activities.

Maintenance, Erosion Control Measures Will Be Maintained At All Times. If Full Implementation Of The Approved Plan Does Not Provide For Effective Erosion Control, Additional Erosion And Sediment Control Measures Shall Be Implemented To Control Or Treat The Sediment Source.

All Sediment Controls And Critical Slopes 3:1 Must Be Stabilized Within Seven Calendar Days Of Disturbance. All Other Disturbed Areas Of The Project Site Must Be Stabilized Within Fourteen Calendar Days.

All Points Of Ingress And Egress Shall Be Protected To Minimize Tracking Of Mud Onto Public Right-of-ways And Roads. Any Earth, Gravel, And/or Other Material Tracked, Spilled, Or Washed Onto Road Or Adjacent Properties Must Be Immediately Removed And Disposed Of In A Proper Manner. Flushing Will Not Be Permitted. All Material Must Be Removed By Means Of Shoveling And Sweeping.

Sediment Control Devices Are To Remain In Place Until Site Is Permanently Stabilized.

After Site Is Permanently Stabilized And Before Erosion Control Measures Are Removed, The Contractor Shall Clean Debris And Silt From All Storm Sewers, Structures And Ditches In Area Of Work.

All Excavated Material Shall Be Placed On High Side Whenever Possible And Confined To An Area Where It Will Not Obstruct The Normal Flow Of The Drainage.

Pumping Of Sediment Laden Water Will Not Be Allowed Unless It Is Filtered By Way Of An Approved Sediment Trapping Device.

The Contractor Shall Also Be Responsible For Keeping Filters And Silt Fences Clear Of Sediment Buildup During Construction.

Continuous Inspection And Maintenance Of The Sediment Control Devices Is Mandatory.

Any Sediment Control Devices Disturbed During Site Grading And Utility Construction Must Be Restored Immediately.

Expose The Smallest Areas Of Soil For As Short A Time As Possible.

Keep Dust Within Tolerable Limits By Sprinkling Or Other Acceptable Means. Use Temporary Vegetation And / Or Mulch To Protect Bare Areas From Erosion During Construction.

All Cull/ill Areas To Have A Minimum Of 6-inch Depth Topsoil Cover. Areas Dressing With Topsoil Will Receive 12 Pounds Per 1000 Square Feet Of Fertilizer, 8 Pounds Or More Of Seed Per 1000 Square Feet (See 1001 Seed Chart) And A Straw Mulch Of 70% - 80% Coverage (Approximately 125 Pounds Per 1000 Square Feet) Except As Otherwise Determined By Plan.

Disturbed Areas Are To Be Graded To Drain As Indicated On Plan To Sediment Barriers During And Upon Completion Of Construction.

Upon Stabilization Of The Project Site With A Good (acceptable) Stand Of Grass And/or Ground Cover, The Erosion Installations Will Be Removed And The Area Disturbed Will Be Seeded And Mulched With The Same Treatment As Other New Grassed Areas Of The Project. Any Areas That Are Left Disturbed For Over 14 Days, The Contractor Shall Stabilize With Temporary Seeding And Mulching, With The Same Treatment As Other New Grassed Areas Of The Project.

When Two Sections Of Silt Fence Are Joined Together, They Shall Be Overlapped, Folded And Stapled To Prevent Sediment Bypass. Silt Fence To Be Fastened Securely Every 5' Along First Accumulated Sediment Must Be Removed When It Reaches 50% Of The Height Of The Fabric, Wood Posts, 2"x2" Hardwood With Min. Cross Section Area Of 3 Inches, Steel Post, Either T Or U Type, Not Weighing Less Than 1 Lb./ft. Silt Fence: Per Tdol Section S-0-27, Asphalt M 298, Class A.

Contractor shall provide an area for concrete washdown and equipment fueling in accordance with Metro CP-10 and CP-13 respectively. Contractor to coordinate exact location with NPDES department during preconstruction meeting. Control of other site wastes such as discarded building material, chemical, litter, and sanitary wastes that may cause adverse impact to water quality is also required by the Grading Permittee.

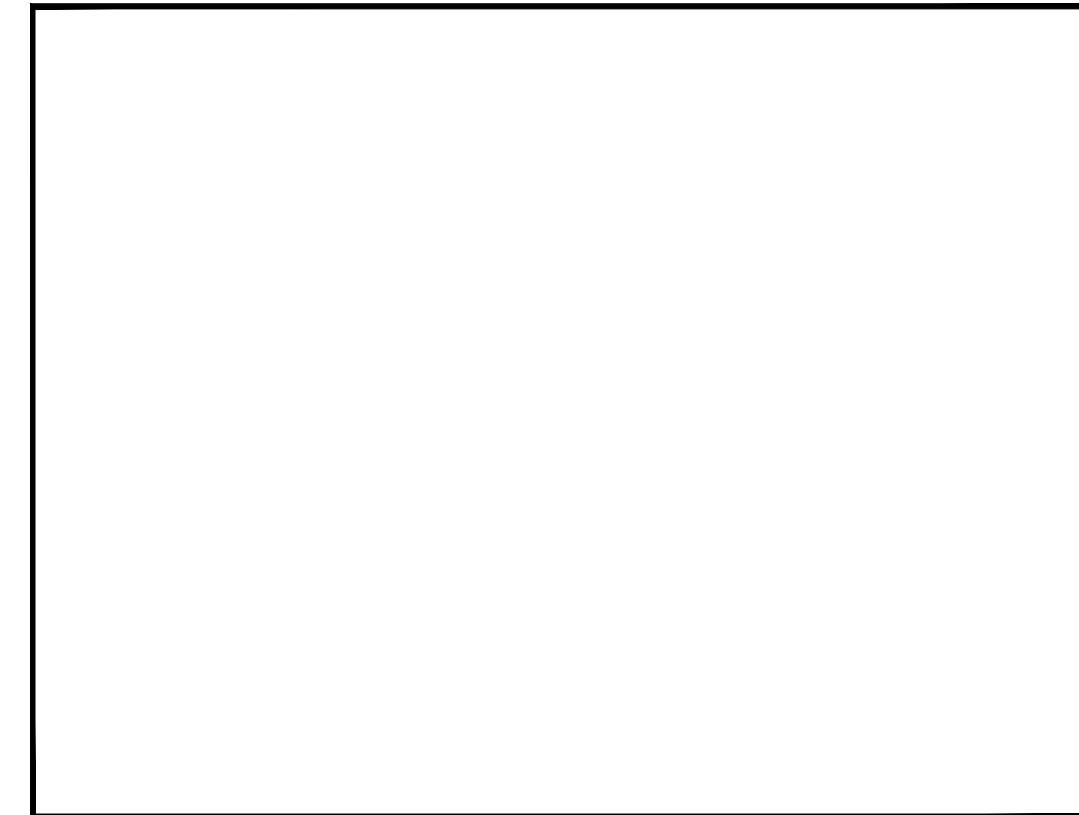

LEGEND

PARCEL NO.	()
IRON ROD (OLD)	○ IR(O)
CONC MON (OLD)	⊠ MON(O)
IRON ROD (SET)	● IR(N)
PROPERTY LINE	—
CONTOUR LINE	50.2
FENCE	—
OVERHEAD POWER LINE	OH
SANITARY SEWER LINE	15"RCP
STORM SEWER LINE	15"RCP
WATER LINE	—
GAS LINE	—
TREE DRIP LINE	—
UTILITY POLE	○
GUY WIRE	←
LIGHT POST	☆
SANITARY SEWER MANHOLE	⊙
CURB INLET	⊞
CATCH BASIN	⊞
FIRE HYDRANT	⊞
WATER METER	W
WATER VALVE	WV
CONCRETE	⊞

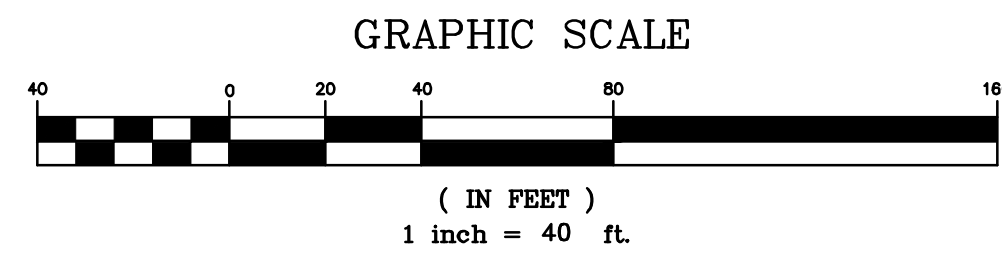
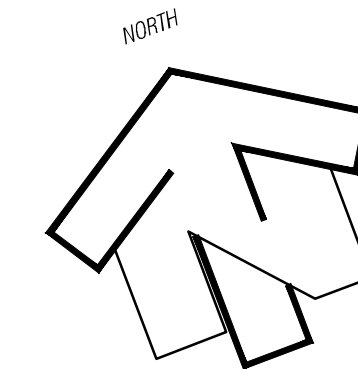

PAUL W. BROOME
BK. 8687, PG. 595
(T.M. 94-12, PAR 30)
LOT 35
CLOVER NOOK
P.B. 2900, PG. 51
Zoning RS10

James C. Stemp, Sr.
I.N. 201105270040785
(T.M. 94-12, Par 31)
Lot 1
The Resubdivision Of Lot 34
Cloverbrook Subd.
P.B. 5200, Pg. 709
Zoning RS10



IT IS THE CONTRACTOR'S RESPONSIBILITY TO CONTACT UTILITY COMPANIES PRIOR TO ANY CONSTRUCTION. THE LOCATION OF UTILITIES SHOWN ON THESE PLANS ARE APPROXIMATE AND POSSIBLY INCOMPLETE. THEREFORE CERTIFICATION TO THE LOCATION OF ALL UNDERGROUND UTILITIES IS WITHHELD.

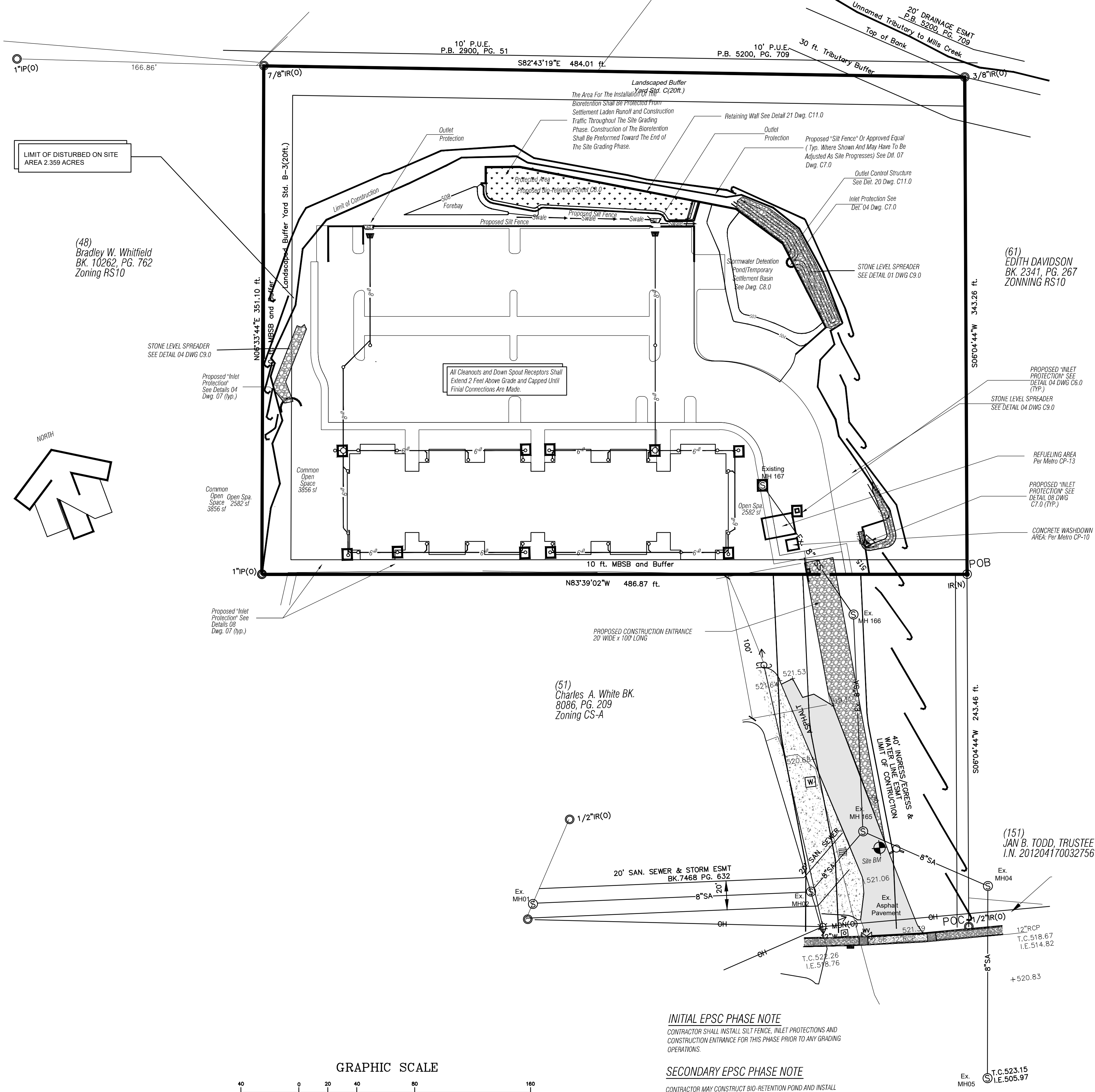

INITIAL EPSC PHASE NOTE
CONTRACTOR SHALL INSTALL SILT FENCE, INLET PROTECTIONS AND CONSTRUCTION ENTRANCE FOR THIS PHASE PRIOR TO ANY GRADING OPERATIONS.

SECONDARY EPSC PHASE NOTE
CONTRACTOR MAY CONSTRUCT BIO-RETENTION POND AND INSTALL INLET PROTECTION AROUND OUTLET STRUCTURE FOR SITE EPSC MEASURES.

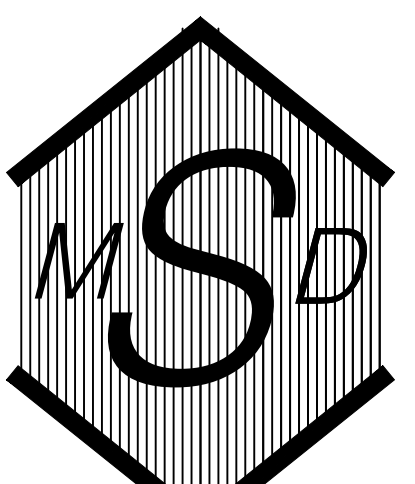

MURRAY D. SHANKLIN, PE
P.O. BOX 9
PORTLAND, TN 37148
615.512.2911
Email: mshanklin@bellsouth.net

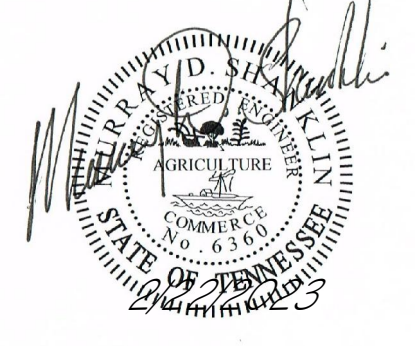

Drawn: MDS
Checked By: MDS
Project No.: 16 ROBERT BERARD
Date: 07/15/2019

Revised 06/21/2016
Revised 07/03/2016

A New Multiply Family Home Complex
Apartment Concept
1636 Lebanon Pike
Nashville, Tennessee
Parcel No. 09400005000 and 09400004900

SHEET TITLE:
**Phase 2
EPSC
Plan**

SHEET NO.
C5.0

Erosion, Sediment And Pollution Control Notes

Erosion Control Work Performed By The Contractor Shall Conform To The Stormwater Permitting Requirements Of The Tennessee Department Of Environment And Conservation, Division Of Water Pollution Control, And The Tennessee Erosion And Sediment Control Handbook Latest Edition.

The Escape Of Sediment From The Site Shall Be Prevented By The Installation Of Erosion Control Measures And Practices Prior To Or Concurrent With Land-Disturbing Activities.

Maintenance, Erosion Control Measures Will Be Maintained At All Times. If Full Implementation Of The Approved Plan Does Not Provide For Effective Erosion Control, Additional Erosion And Sediment Control Measures Shall Be Implemented To Control Or Treat The Sediment Source.

All Sediment Controls And Critical Slopes 3:1 Must Be Stabilized Within Seven Calendar Days Of Disturbance. All Other Disturbed Areas Of The Project Site Must Be Stabilized Within Fourteen Calendar Days.

All Points Of Ingress And Egress Shall Be Protected To Minimize Tracking Of Mud Onto Public Right-of-Ways And Roads. Any Earth, Gravel, And/Or Other Material Tracked, Spilled, Or Washed Onto Road Or Adjacent Properties Must Be Immediately Removed And Disposed Of In A Proper Manner. Flushing Will Not Be Permitted. All Material Must Be Removed By Means Of Sweeping And Sweeping.

Sediment Control Devices Are To Remain In Place Until Site Is Permanently Stabilized. After Site Is Permanently Stabilized And Before Erosion Control Measures Are Removed, The Contractor Shall Clean Debris And Silt From All Storm Sewers, Structures And Ditches In Area Of Work.

All Excavated Material Shall Be Placed On High Side Wherever Possible And Confined To An Area Where It Will Not Obstruct The Normal Flow Of The Drainage.

Pumping Of Sediment Laden Water Will Not Be Allowed Unless It Is Filtered By Way Of An Approved Sediment Trapping Device.

The Contractor Shall Also Be Responsible For Keeping Filters And Silt Fences Clear Of Sediment Buildup During Construction.

Continuous Inspection And Maintenance Of The Sediment Control Devices Is Mandatory.

Any Sediment Control Devices Disturbed During Site Grading And Utility Construction Must Be Restored Immediately.

Expose The Smallest Areas Of Soil For As Short A Time As Possible.

Keep Dust Within Tolerable Limits By Sprinkling Or Other Acceptable Means. Use Temporary Vegetation And / Or Mulch To Protect Bare Areas From Erosion During Construction.

All Cut/Fill Areas To Have A Minimum Of 6-inch Depth Topsoil Cover. Areas Dressed With Topsoil Will Receive 12 Pounds Per 1000 Square Feet Of Fertilizer, 8 Pounds Or More Of Seed Per 1000 Square Feet (see Top Seed Chart) And A Straw Mulch Of 70% - 80% Coverage (approximately 125 Pounds Per 1000 Square Feet) Except As Otherwise Determined By Plan.

Disturbed Areas Are To Be Graded To Drain As Indicated On Plan To Sediment Barriers During And Upon Completion Of Construction.

Upon Stabilization Of The Project Site With A Good (acceptable) Stand Of Grass And/Or Ground Cover, The Erosion Control Measures Shall Be Removed And The Area Disturbed Will Be Seeded And Mulched With The Same Treatment As Other New Grassed Areas Of The Project. Any Areas That Are Left Disturbed For Over 14 Days, The Contractor Shall Stabilize With Temporary Seeding And Mulching, With The Same Treatment As Other New Grassed Areas Of The Project.

When Two Sections Of Silt Fence Are Joined Together, They Shall Be Overlapped, Folded And Stapled To Prevent Sediment Bypass. Silt Fence To Be Fastened Securely Every 10' Along Post. Accumulated Sediment Must Be Removed When It Reaches 50% Of The Height Of The Fabric. Wood Posts, 2"x2" Hardwood With Min Cross Section Area Of 3 Inches. Steel Post, Either T Or U Type, Not Weighing Less Than 1 Lb./ft. Silt Fence: Per Detail Section S-27, AASHTO M 298, Class A.

Contractor shall provide an area for concrete washdown and equipment fueling in accordance with Metro CP-10 and CP-13 respectively. Contractor to coordinate exact location with MPDES department during preconstruction meeting. Control of other site wastes such as discarded building material, chemical, litter, and sanitary wastes that may cause adverse impact to water quality is also required by the Grading Permits.

PAUL W. BROOME
BK. 8687, PG. 595
(T.M. 94-12, PAR 30)
LOT 35
CLOVER NOOK
P.B. 2900, PG. 51
Zoning RS10

James C. Stemp, Sr.
I.N. 201105270040785
(T.M. 94-12, PAR 31)
Lot 1
The Resubdivision Of Lot 34
Cloverbrook Subd.
P.B. 5200, PG. 709
Zoning RS10



IT IS THE CONTRACTORS RESPONSIBILITY TO CONTACT UTILITY COMPANIES PRIOR TO ANY CONSTRUCTION. THE LOCATION OF UTILITIES SHOWN ON THESE PLANS ARE APPROXIMATE AND POSSIBLY INCOMPLETE. THEREFORE CERTIFICATION TO THE LOCATION OF ALL UNDERGROUND UTILITIES IS WITHHELD.



MURRAY D. SHANKLIN, PE
P.O. BOX 9
PORTLAND, TN 37148
615.512.2911
Email: mds Shanklin@bellsouth.net

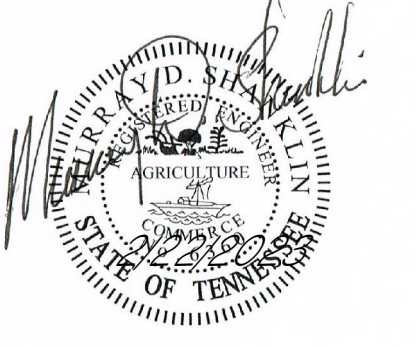

Drawn MDS
Checked By MDS
Project No. 16 ROBERT BERARD
Date 07/15/2019

Revised 06/21/2016
Revised 07/03/2016
Revised 03/08/2019

A New Multiply Family Home Complex
Apartment Concept
1636 Lebanon Pike
Nashville, Tennessee
Parcel No. 09400005000 and 09400004900

SHEET TITLE:
Final EPSC Plan

SHEET NO.
C6.0

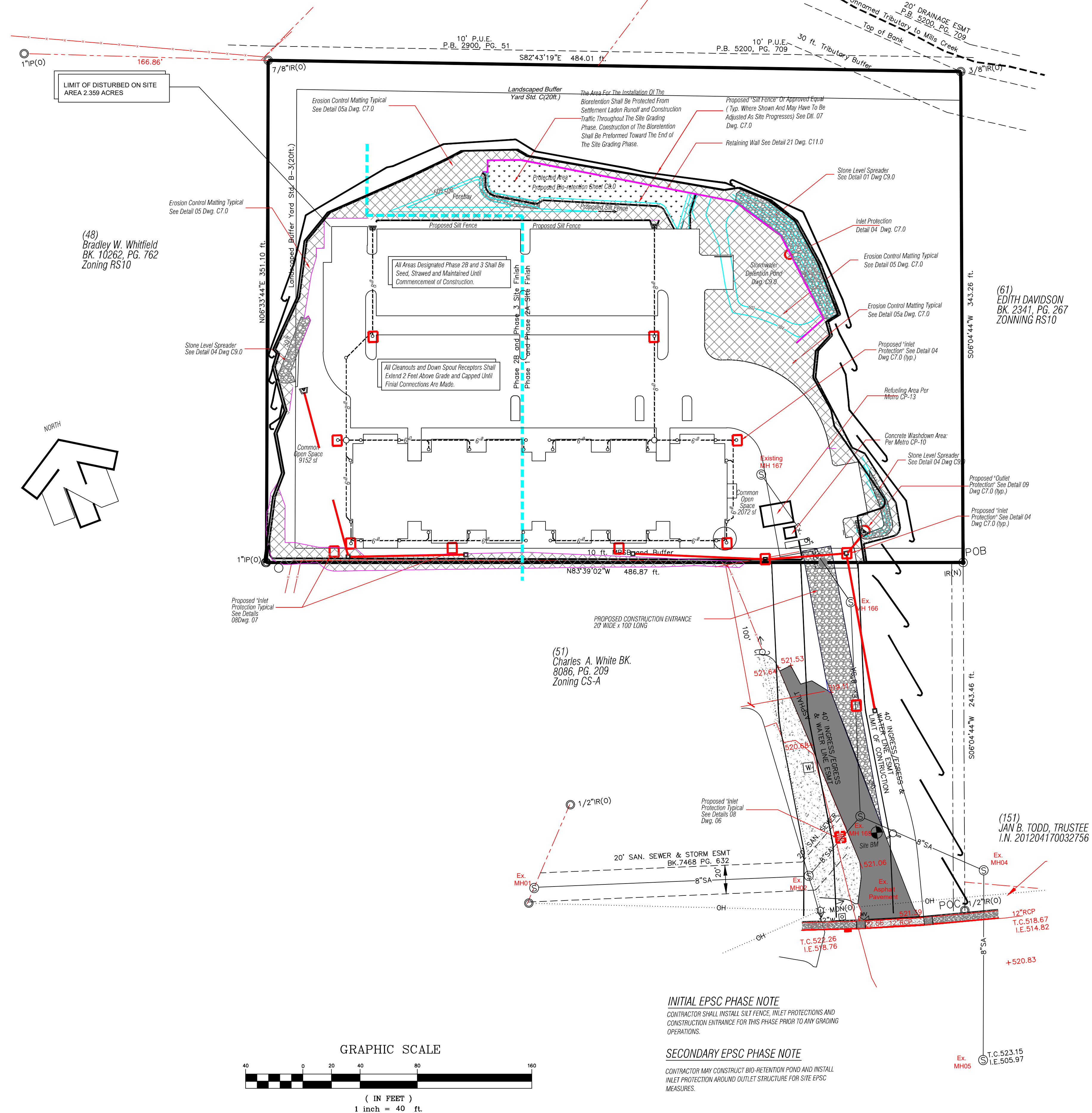

INITIAL EPSC PHASE NOTE
CONTRACTOR SHALL INSTALL SILT FENCE, INLET PROTECTIONS AND CONSTRUCTION ENTRANCE FOR THIS PHASE PRIOR TO ANY GRADING OPERATIONS.

SECONDARY EPSC PHASE NOTE
CONTRACTOR MAY CONSTRUCT BIO-RETENTION POND AND INSTALL INLET PROTECTION AROUND OUTLET STRUCTURE FOR SITE EPSC MEASURES.

These plans and specifications are the property of MURRAY D. SHANKLIN, PE. Any reproduction, publication, exhibition, or use of all or any part thereof without the express written consent of MURRAY D. SHANKLIN, PE. is strictly prohibited. Anyone violating these plans is deemed to agree to the above and that MURRAY D. SHANKLIN, PE. shall be entitled to recover reasonable attorneys' fees in any action to enforce the above provisions.

These plans and specifications are the property of Murray D. Shanklin, P.E. and shall remain confidential. Any reproduction, publication, exhibition, or use of all or any part thereof without the express written consent of Murray D. Shanklin, P.E. is strictly prohibited. Anyone viewing these plans is deemed to agree to the above and that Murray D. Shanklin, P.E. shall be entitled to recover reasonable damages and attorney's fees in any action to enforce the above provisions.

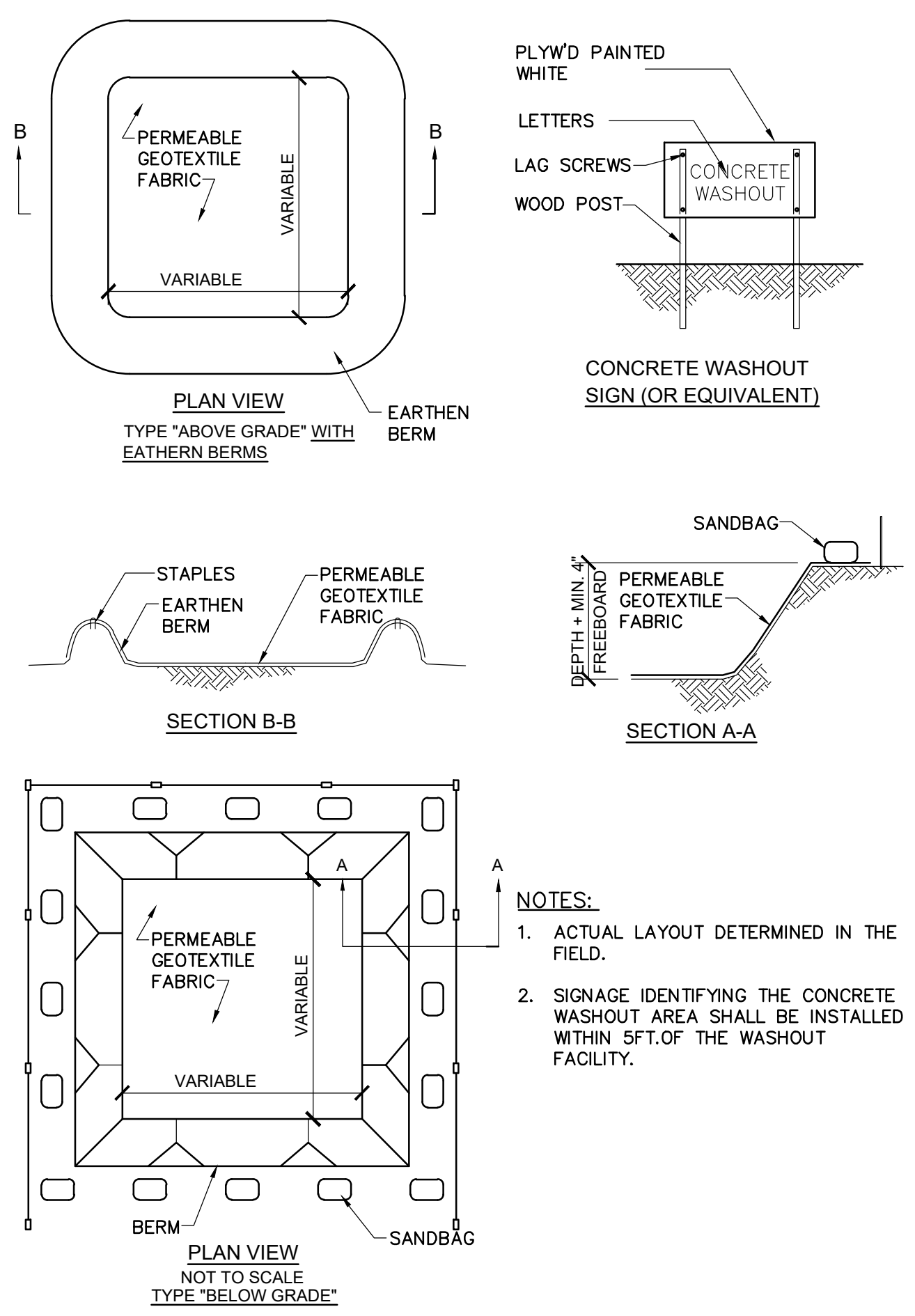

Temp. Erosion Control - Metro CP-10 N.T.S. 01 Detail Concrete Washdown Area

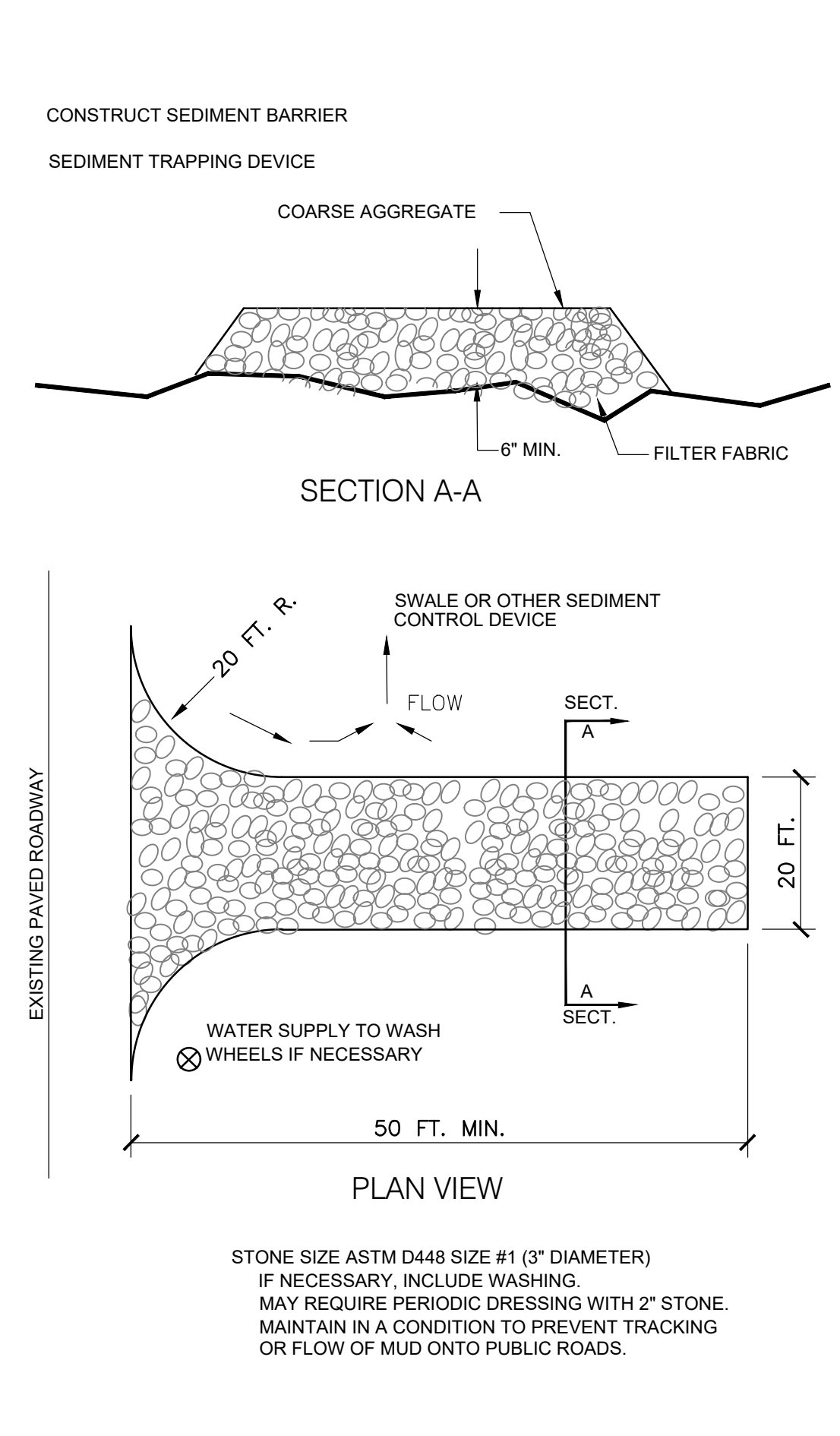

Temp. Erosion Control - Metro TCP-03 N.T.S. 02 Temp. Construction Entrance/exit

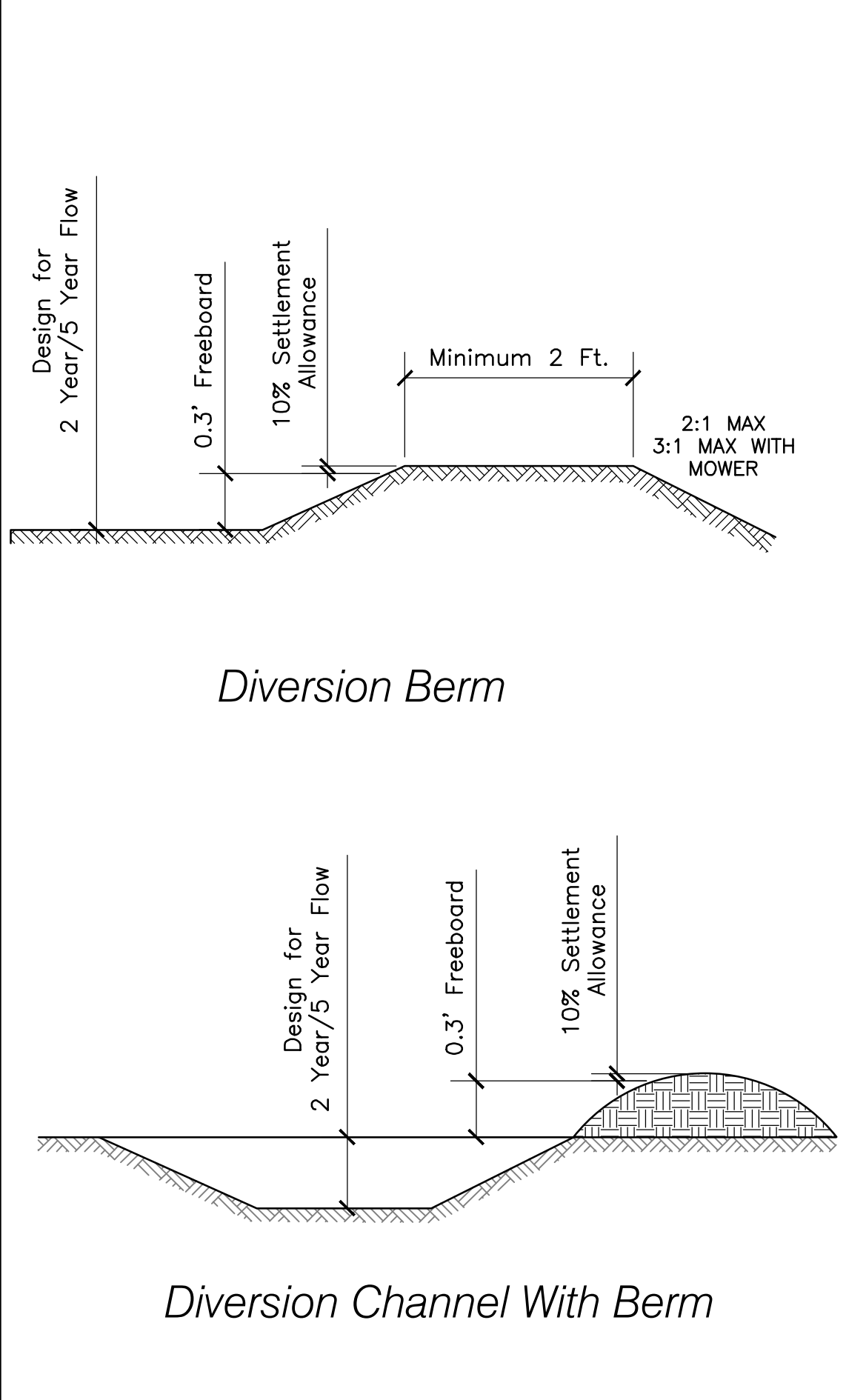

Temp. Erosion Control - Metro TCP-22 N.T.S. 03 Temporary Diversion

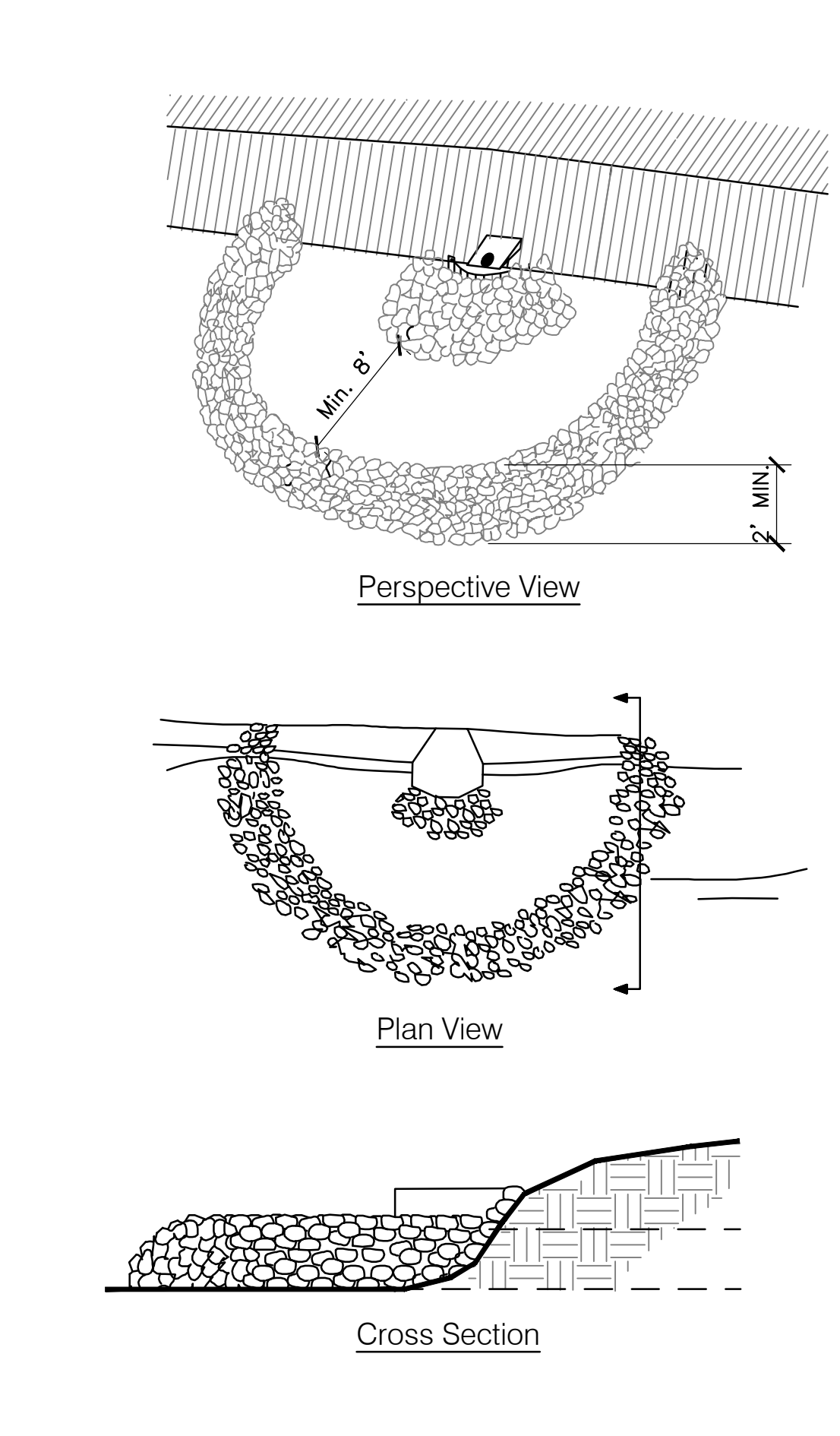

Temp. Erosion Control - Metro TCP-24 N.T.S. 04 Detail Stone Filter Inlet Protection

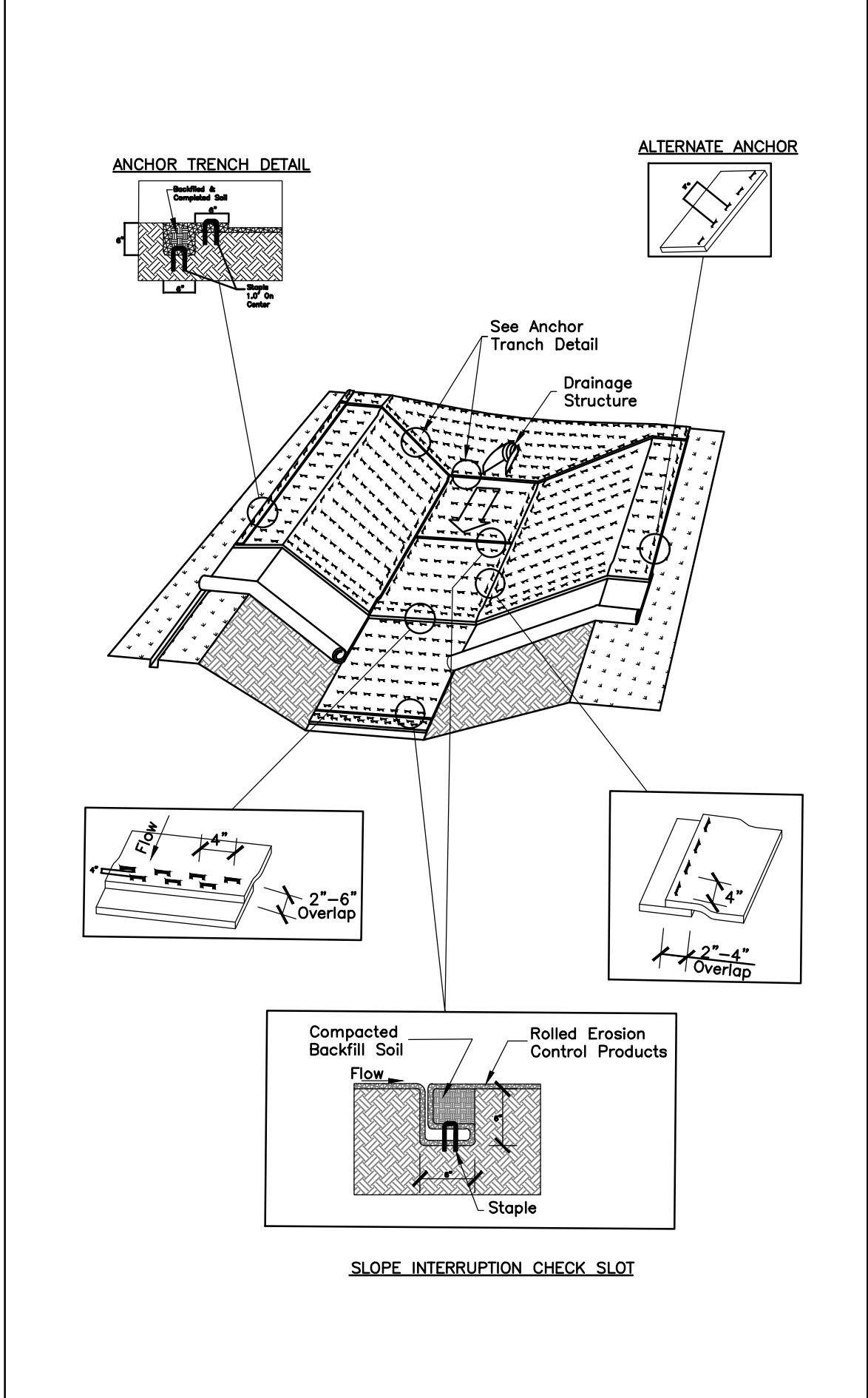

Temp. Erosion Control - Metro TCP-09 N.T.S. 05 Detail Net and Mats

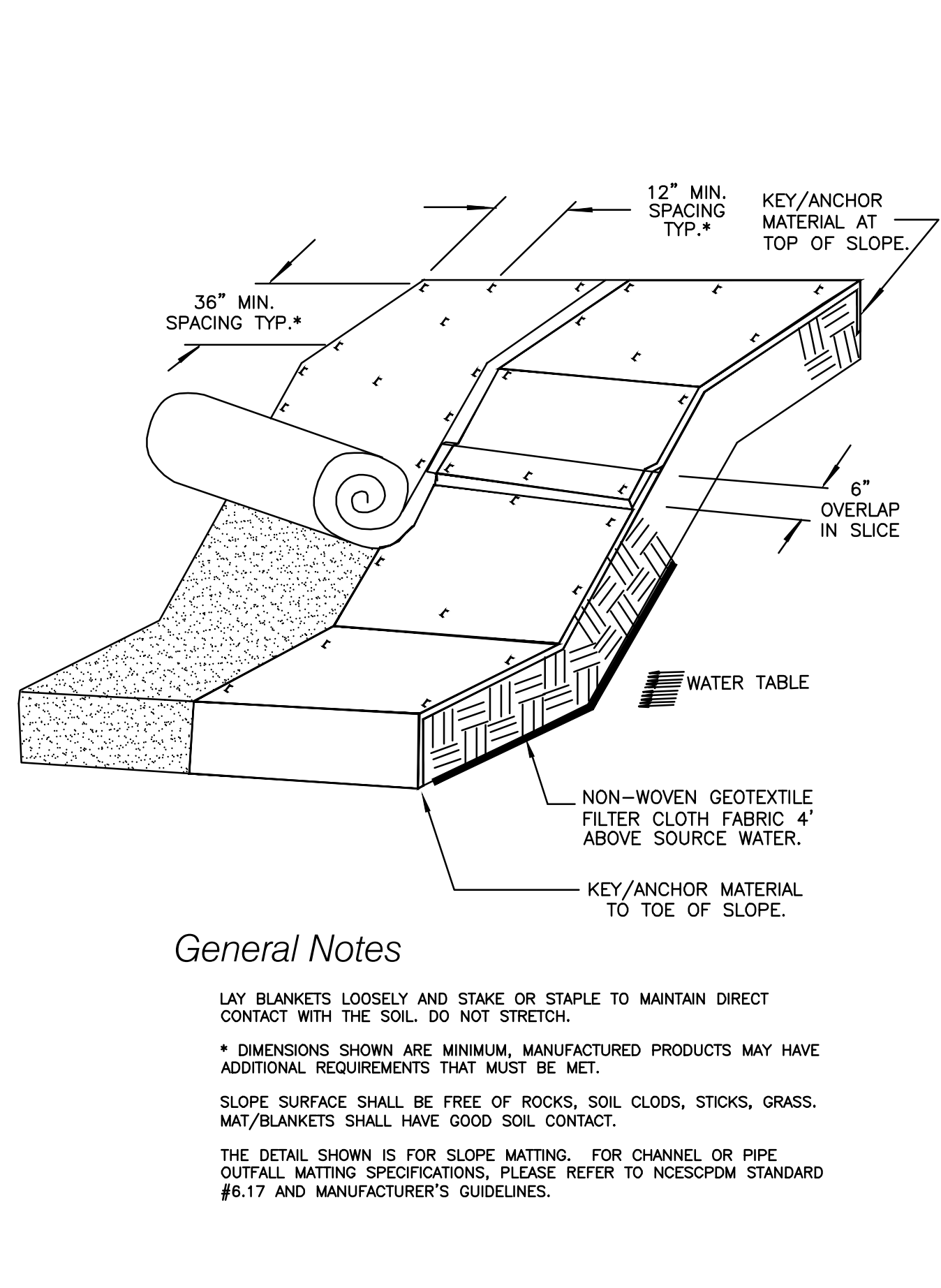

Temp. Erosion Control - Metro TCP-10 N.T.S. 05a Detail Embankment Matting

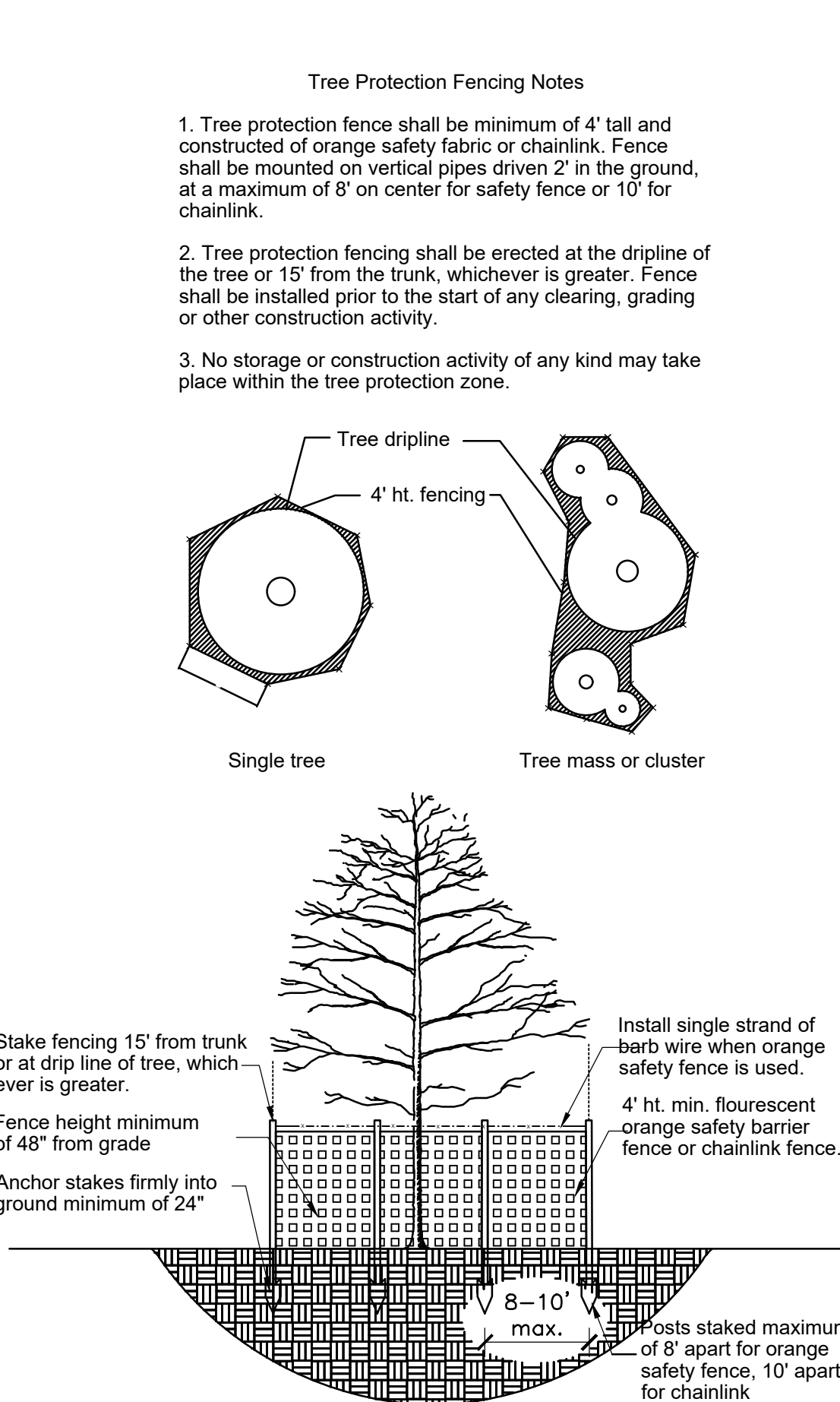

Temp. Erosion Control - Metro N.T.S. 06 Tree Protection Detail

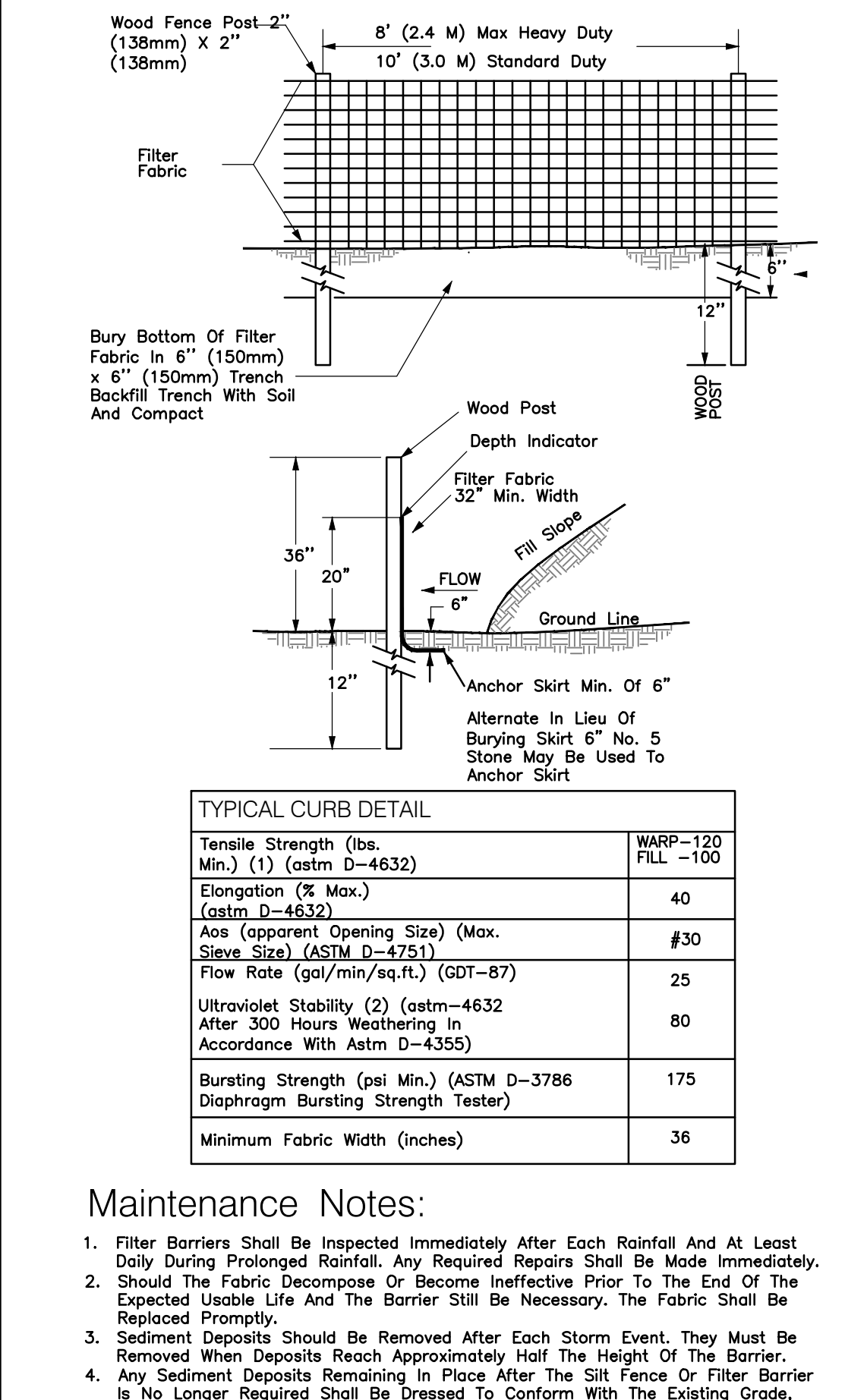

Temp. Erosion Control - Metro TCP-13 N.T.S. 07 Detail Silt Fence

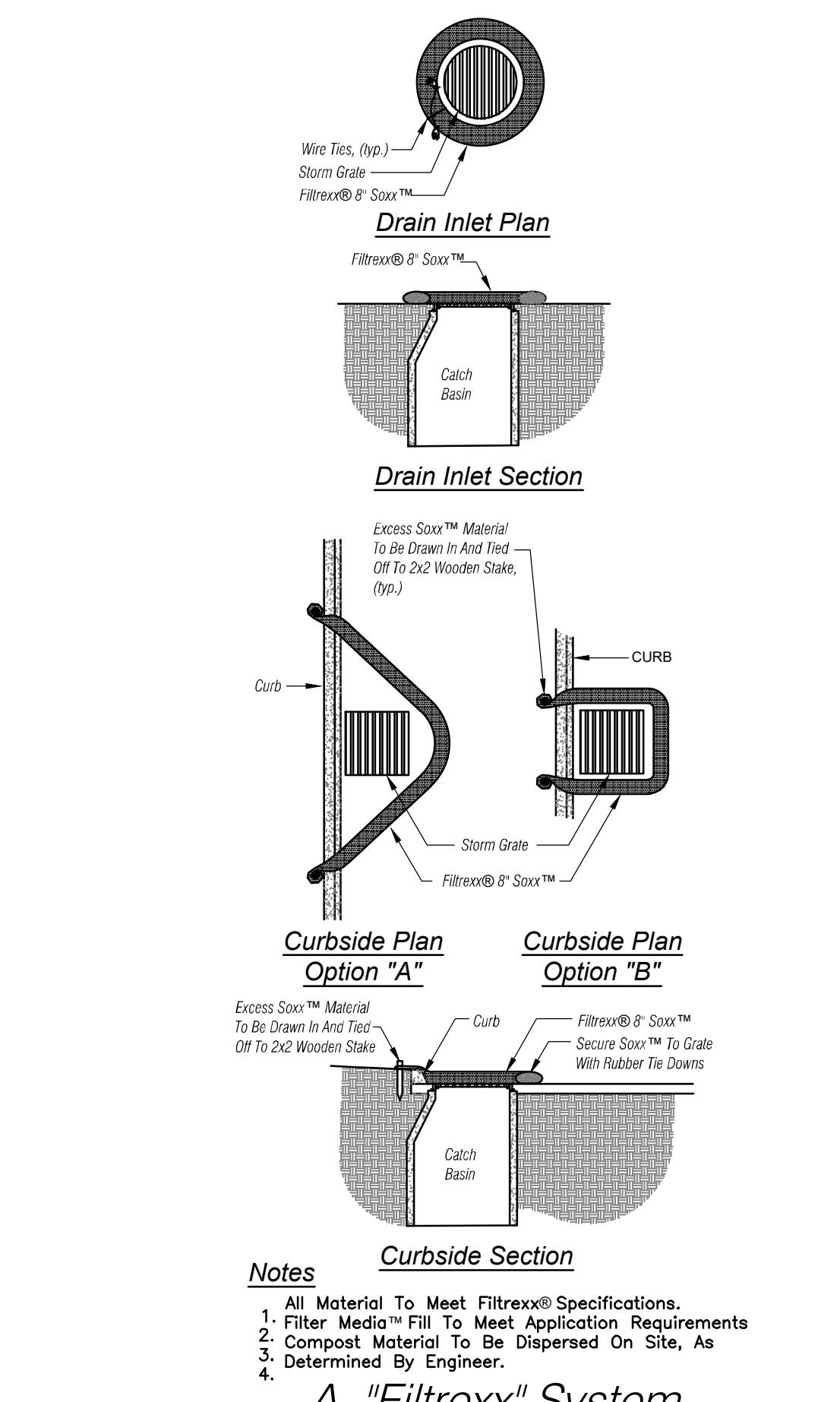

Temporary Erosion Control Per Metro TCP-24 08 Detail Inlet Protection

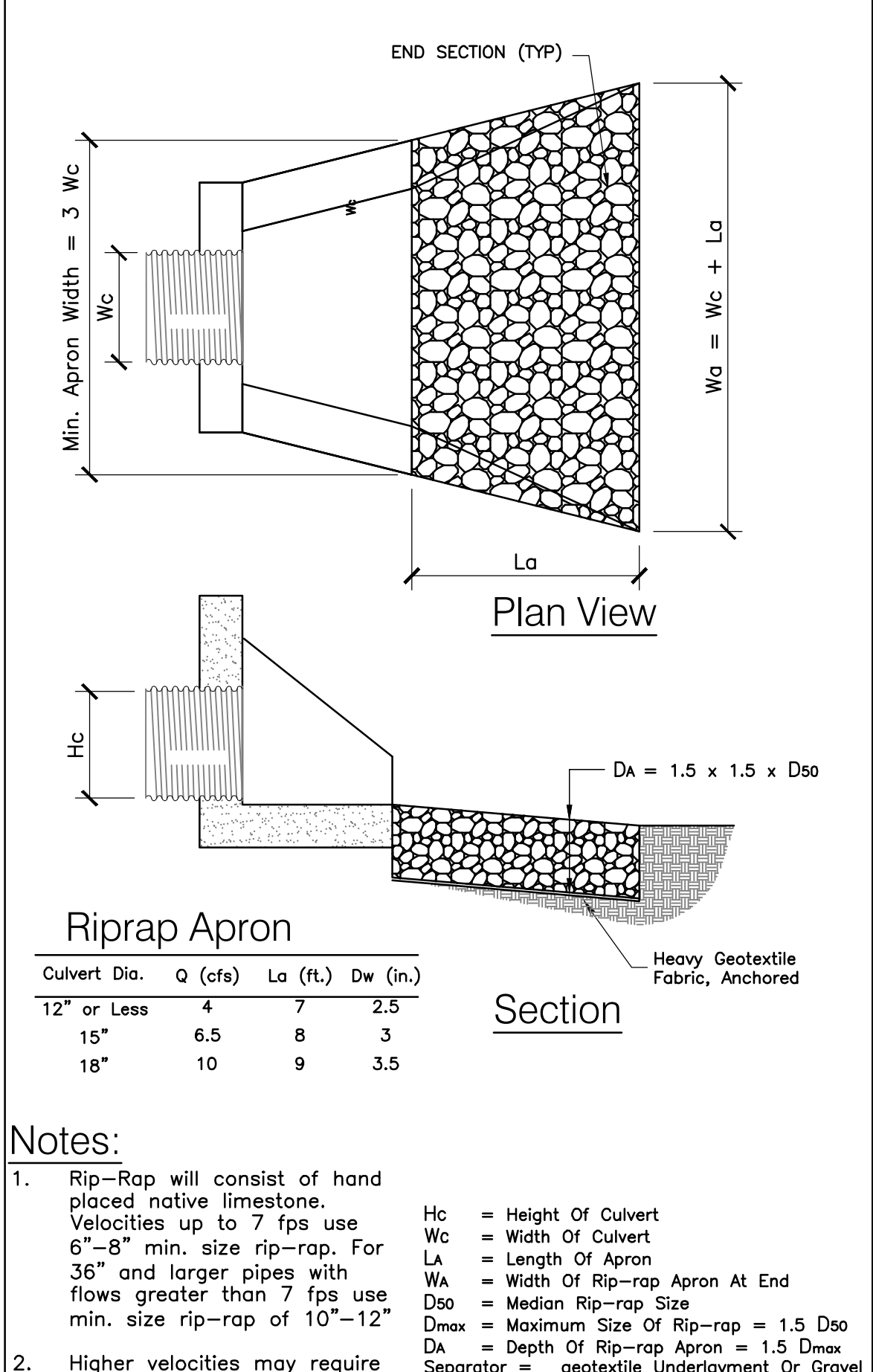

Temp. Erosion Control - Metro TCP-09 N.T.S. 09 Detail Rip-Rap Outlet Protection N.T.S. METRO PROJECT 2016SP-29-003

MURRAY D. SHANKLIN, P.E.
P.O. BOX 9
PORTLAND, TN 37148
615.512.2911
Email: mshanklin@south.net

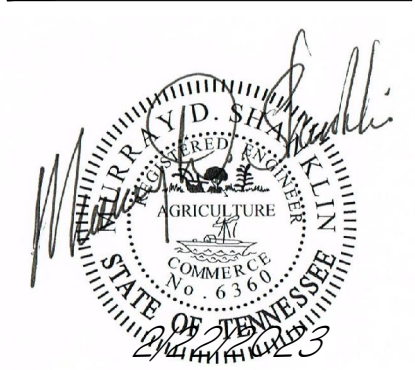

Drawn	MDS
Checked By	MDS
Project No.	16 ROBERT BERARD
Date	07/15/2019
Revised	06/21/2016
Revised	07/03/2016
Revised	03/08/2019

A New Multiply Family Home Complex
Apartment Concept
1636 Lebanon Pike
Nashville, Tennessee
Parcel No. 09400005000 and 09400004900

SHEET TITLE:
EPSC Details

SHEET NO.

C7.0

These plans and specifications are to be used only for the project herein. Any reproduction, publication, distribution, or use of all or any part thereof without the express written consent of MURRAY D. SHANKLIN, PE, is strictly prohibited. Any reproduction, publication, distribution, or use of all or any part thereof without the express written consent of MURRAY D. SHANKLIN, PE, shall be deemed to be a violation of the copyright laws of the State of Tennessee.

SEWER
METRO WATER AND SEWERAGE SERVICES
1800 SECOND AVENUE NORTH
NASHVILLE, TN 37208
(615) 862-4505

GAS
PIEDMONT NATURAL GAS
665 MAINSTREAM DRIVE
NASHVILLE, TN 37229
(704) 364-3120

CABLE
COMCAST
660 MAINSTREAM DRIVE
NASHVILLE, TN 37228
(615) 244-5000

ELECTRIC
NES NASHVILLE ELECTRIC SERVICE
1214 CHURCH STREET
NASHVILLE, TN 37203
(615) 747-3641

TELEPHONE
AT&T
2501 PARK PLAZA
NASHVILLE, TN 37203
(615) 344-5288

UTILITY NOTES

- ALL SEWER CONSTRUCTION SHALL BE IN ACCORDANCE WITH SPECIFICATIONS AND STANDARD DETAILS OF THE METRO WATER SERVICES AND OSHA GUIDELINES.
- THE CONTRACTOR IS RESPONSIBLE FOR REIMBURSING THE METRO WATER SERVICES THE COST OF INSPECTION.
- THE CONTRACTOR IS TO PROVIDE AND MAINTAIN THE CONSTRUCTION IDENTIFICATION SIGN FOR PRIVATE DEVELOPMENT APPROVED.
- AFTER COMPLETION OF THE SANITARY SEWER, THE DEVELOPER IS RESPONSIBLE FOR THE TELEVISIONING OF THE LINES PRIOR TO FINAL ACCEPTANCE. THE VIDEO TAPING MUST BE COORDINATED WITH THE METRO WATER SERVICES INSPECTION SECTION. ALL COSTS WILL BE BORNE BY THE DEVELOPER.
- ALL CONNECTIONS TO EXISTING MANHOLES OR CATCHBASINS SHALL BE BY CORING AND RESILIENT CONNECTOR METHOD.
- UPON COMPLETION OF CONSTRUCTION OF SEWER, THE ENGINEER SHALL PROVIDE THE DEPARTMENT WITH A COMPLETE SET OF AS-BUILT PLANS ON MOIST ERASABLE MYLAR IN REVERSE AND IN DIGITAL (.DWG) FORMAT. SEWER PLANS SHALL BE SEALED BY A LICENSED PROFESSIONAL ENGINEER OR A REGISTERED LAND SURVEYOR AND SHALL INCLUDE ACTUAL FIELD ANGLES BETWEEN LINES, ALL ACTUAL SERVICE LINES AND TEE LOCATIONS, THE DISTANCE OF THE END OF THE SERVICE LINE TO PROPERTY CORNERS AND LINES AND/OR STATION AND OFFSET FROM SEWER CENTERLINE TO END OF SERVICE LINE, THE DEPTH TO THE TOP OF THE END OF THE SERVICE LINE, AND SHALL REFLECT ALL ALIGNMENT AND GRADE CHANGES. ALL DRAWINGS MUST BE COMPLETED AND SUBMITTED PRIOR TO ACCEPTANCE OF THE SEWERS INTO THE PUBLIC SYSTEM AND ANY CONNECTIONS BEING MADE.
- UTILITIES SHOWN HEREON WERE TAKEN FROM VISIBLE OBSTRUCTIONS IN THE FIELD. LOCATIONS SHOWN ARE APPROXIMATE AND SHOULD NOT BE RELIED UPON AS ACCURATE. ADDITIONALLY, UTILITIES OTHER THAN THOSE SHOWN MAY BE ENCOUNTERED.
- PRIOR TO CONSTRUCTION, EXCAVATION, OR DISTURBANCE OF THE EXISTING GROUND ELEVATION, THE CONTRACTOR SHALL ASSUME THE RESPONSIBILITY AND EXPENSE OF CONTACTING THE LOCAL UTILITY OWNERS AND DEFINITELY ESTABLISHING THE EXISTENCE, EXACT LOCATIONS AND SIZES OF UNDERGROUND UTILITIES TO AVOID ANY HAZARD OR CONFLICT.
- TENNESSEE LAW REQUIRES NO LESS THAN THREE NOR MORE THAN TEN WORKING DAYS NOTICE TO UNDERGROUND UTILITY OWNERS PRIOR TO INTENT TO EXCAVATE. A LIST OF THESE UTILITIES MAY BE OBTAINED FROM EACH COUNTY'S REGISTER OF DEEDS. THOSE UTILITIES THAT PARTICIPATE IN THE TN ONE-CALL SYSTEM CAN BE NOTIFIED AT 1-800-351-1111.
- CONTRACTOR IS TO PROTECT UTILITIES THAT ARE TO REMAIN AND ALL EXISTING IMPROVEMENTS INCLUDING BUT NOT LIMITED TO STRUCTURES, PAVEMENT, RAMPS, TREES, SIDEWALKS, CURBS, ETC. CONTRACTOR SHALL REPAIR ANY DAMAGE TO EXISTING IMPROVEMENTS AND UTILITIES TO REMAIN ACCORDING TO LOCAL STANDARDS AND AT THE CONTRACTOR'S EXPENSE. CONTRACTOR IS TO COORDINATE ALL CONSTRUCTION WITH THE APPROPRIATE UTILITY AUTHORITIES.

WATER NOTES

- ALL WATER CONSTRUCTION SHALL BE IN ACCORDANCE WITH SPECIFICATIONS AND STANDARD DETAILS OF METRO WATER SERVICES.

WATER QUALITY AND DETENTION

- WATER QUALITY AND DETENTION MEASURES ARE PROVIDED BY A REGIONAL FACILITY AS A PART OF SWGR# 201300135

SCHEDULE OF DRAINAGE STRUCTURE

MARK	DISCRIPTION	TOP OF CASTING ELEV.	INVERT ELEV. In	INVERT ELEV. Out	Slope (%)	Pipe Size	
1	Headwall			513.85	1.00	21"x18" CMP	See Det. 12 Dwg. C10.0
2	Curb Drain	517.75	514.03	514.03	1.00	18"x44" CMP	See Det. 10 Dwg. C10.0
3	Curb Drain	519.00	514.47	514.47	1.00	15"x101" CMP	See Det. 10 Dwg. C10.0
4	Area Drain	519.50	515.48	515.48	1.00	15"x60" CMP	See Det. 11 Dwg. C10.0
5	Area Drain	519.50	516.08	516.08	1.00	15"x92" CMP	See Det. 11 Dwg. C10.0
6	Area Drain	519.00		517.00			See Det. 11 Dwg. C10.0
7	Headwall			509.00			See Det. 12 Dwg. C10.0
8	Area Drain	519.50	516.20	516.20	6.01	18"x107" CMP	See Det. 11 Dwg. C10.0
9	Area Drain	519.50	517.00	517.00	1.00	15"x55" CMP	See Det. 11 Dwg. C10.0
10	Headwall	519.00		509.00			See Det. 15 Dwg. C10.0
11	Junction Box	520.00	517.00	517.00	2.00	8" PVC	See Det. 09 Dwg. C10.0
14	Headwall			509.00			See Det. 12 Dwg. C10.0
12	Junction Box	520.00	517.00	517.00	2.00	8" PVC	See Det. 09 Dwg. C10.0
15	Headwall			509.00			See Det. 12 Dwg. C10.0
13	Outlet Control Structure			502.00	3.00	6" PVC	See Det. 20 Dwg. C11.0

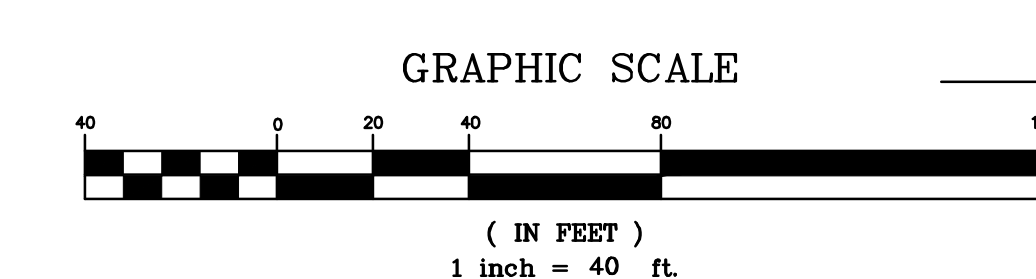
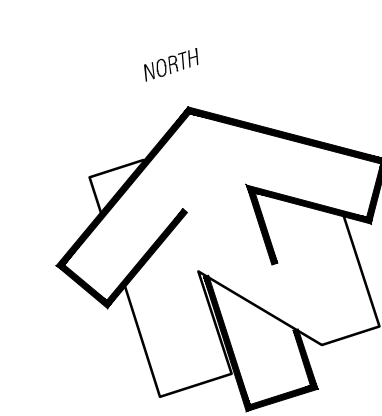
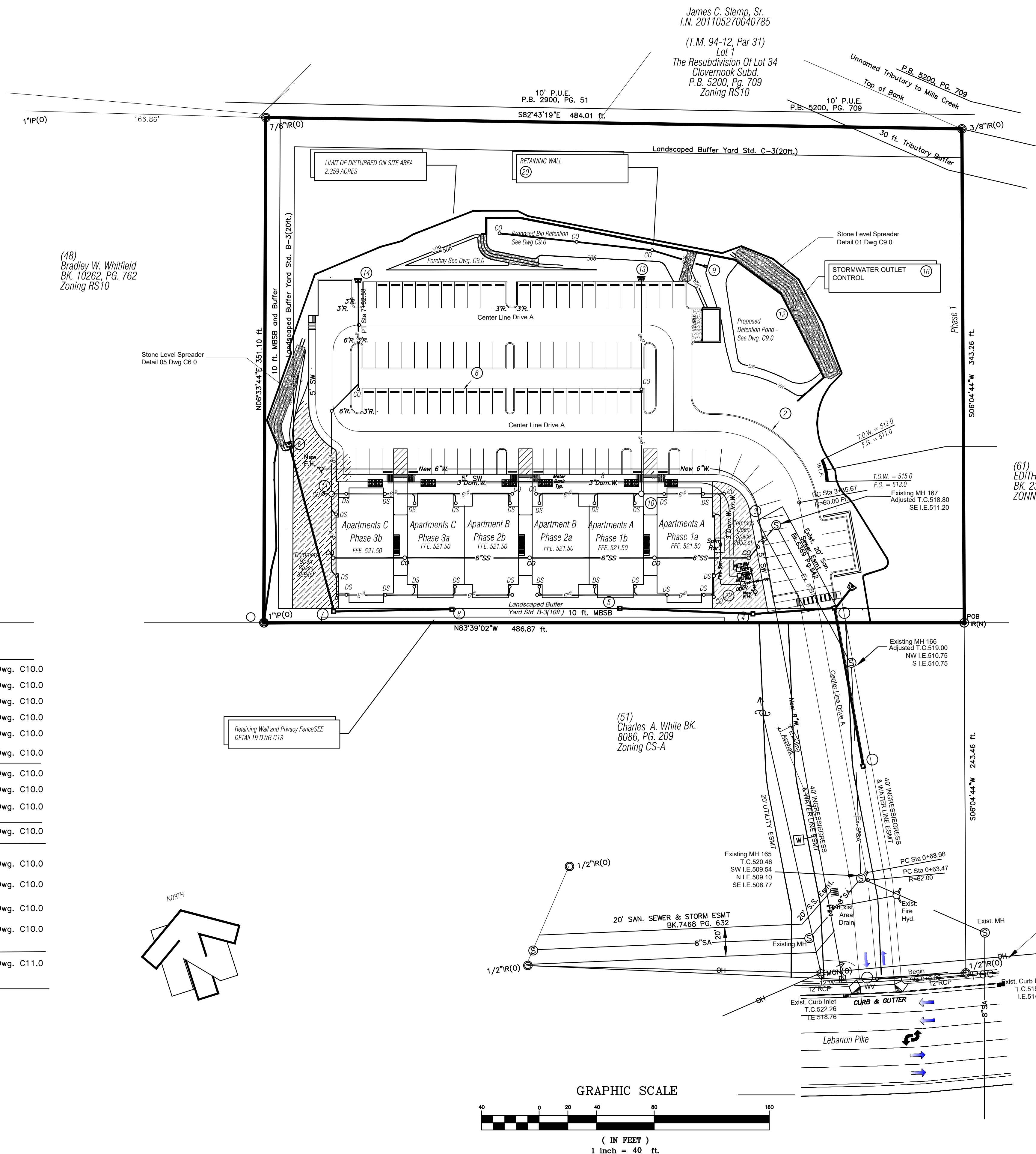

- LEGEND**
- PARCEL NO. ()
 - IRON ROD (OLD) (O) IR(O)
 - CONC MON (OLD) (M) MON(O)
 - IRON ROD (SET) (S) IR(N)
 - PROPERTY LINE
 - CONTOUR LINE 502
 - FENCE
 - OVERHEAD POWER LINE OH
 - SANITARY SEWER LINE
 - STORM SEWER LINE 15"RCP
 - WATER LINE
 - GAS LINE
 - TREE DRIP LINE
 - UTILITY POLE
 - GUY WIRE
 - LIGHT POST
 - SANITARY SEWER MANHOLE
 - CURB INLET
 - CATCH BASIN
 - FIRE HYDRANT
 - WATER METER
 - WATER VALVE
 - CONCRETE

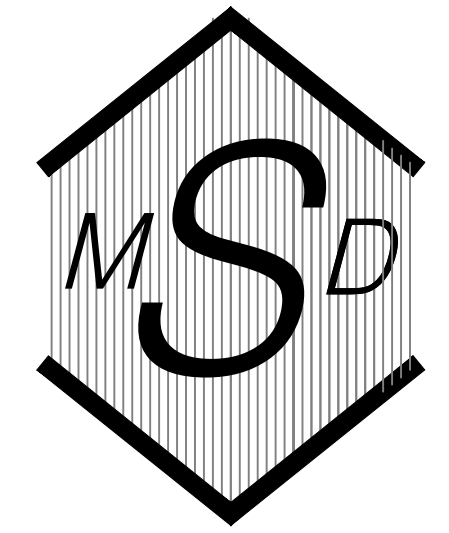

MURRAY D. SHANKLIN, PE
P.O. BOX 9
PORTLAND, TN 37148
615.512.2911
Email: mshanklin@bellsouth.net

Drawn MDS
Checked By MDS
Project No. 16 ROBERT BERARD
Date 07/15/2019

Revised 08/21/2016
Revised 07/03/2016
Revised 03/08/2019
Revised 07/15/2019
Revised 08/03/2020
Revised 10/02/2020
Revised 01/03/2023

A New Multiply Family Home Complex
Apartment Concept
1636 Lebanon Pike
Nashville, Tennessee
Parcel No. 09400005000 and 09400004900

SHEET TITLE:
Utility Plan

SHEET NO.
C8.0

These plans and specifications and all copies hereof, are the sole and exclusive property of MURRAY D. SHANKLIN, P.E. Any reproduction, publication, exhibition, or use of all or any part thereof without the express written consent of MURRAY D. SHANKLIN, P.E. is strictly prohibited. Anyone violating these plans is deemed to agree to the above and that MURRAY D. SHANKLIN, P.E. shall be entitled to recover reasonable damages and attorney's fees in any action to enforce the above provisions.

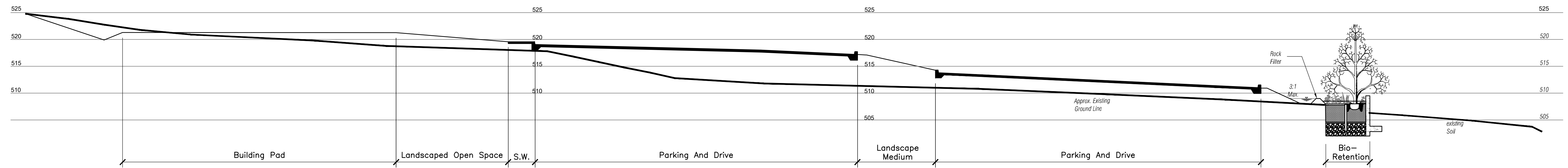

Profile Perpendicular to Bio Retention Stormwater Treatment

Scale 1/4" = One Foot

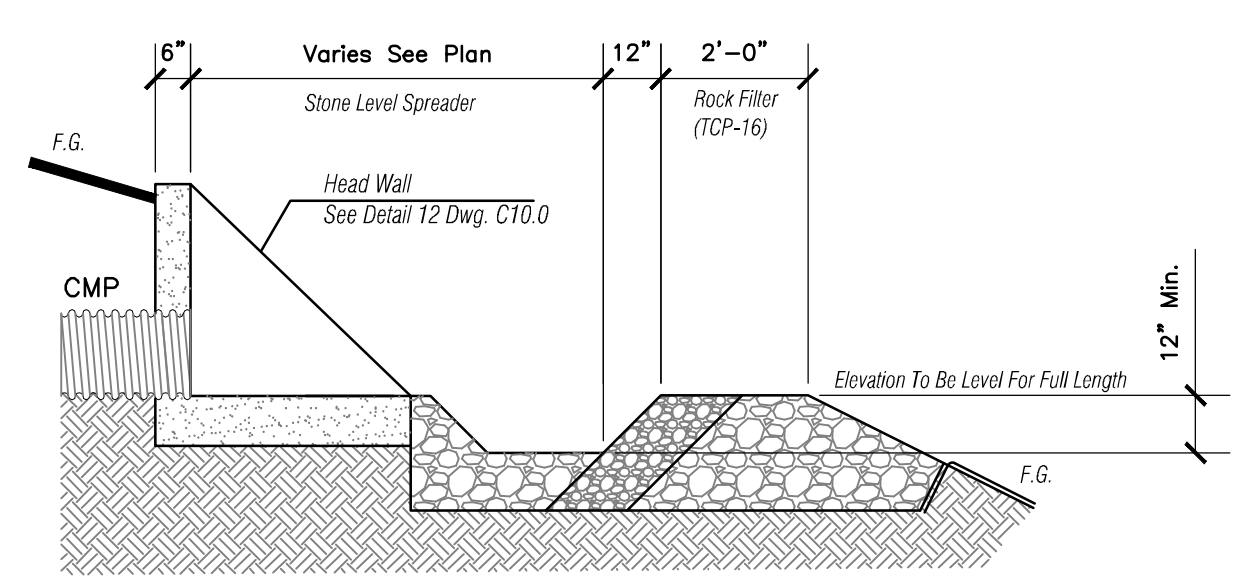

06 Detail
Section Through Headwall At Leveler Stone - Typical

N.T.S.

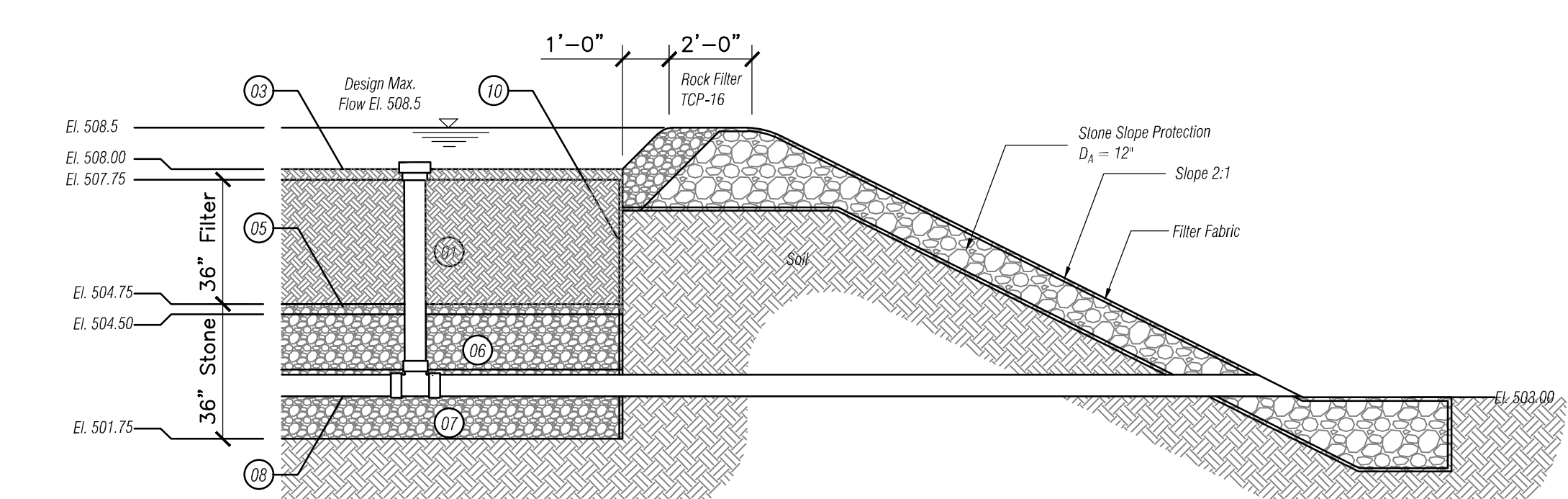

05 Detail
Showing Controlled Overflow

N.T.S.

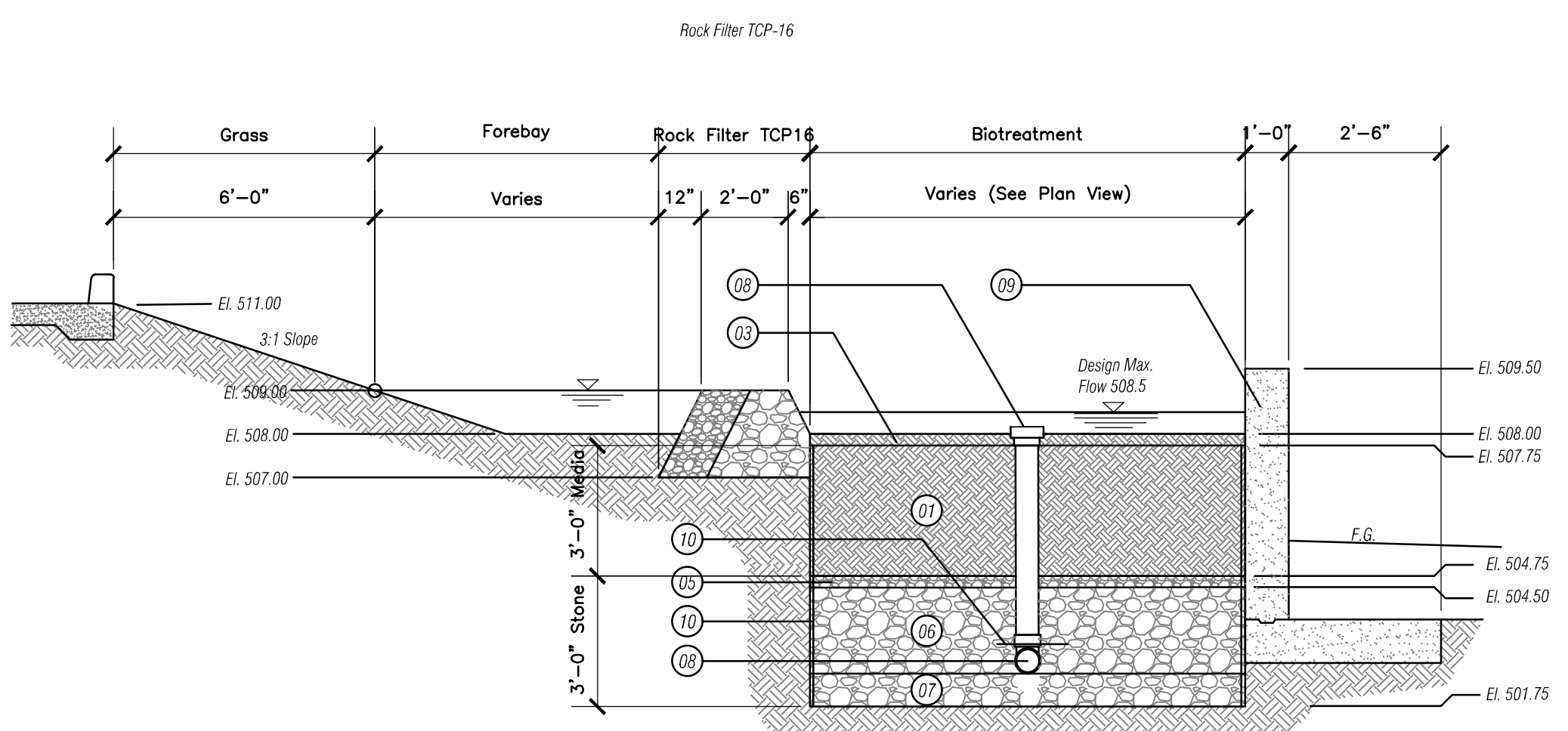

04 Detail
Showing Forebay and Bio-Retention

N.T.S.

Calculated Forebay Area

Elev.	Area	Volume	Tv(req)	Vol. Req.
508.0	612	895	5712*0.15 = 857 cf	
509.0	1176			

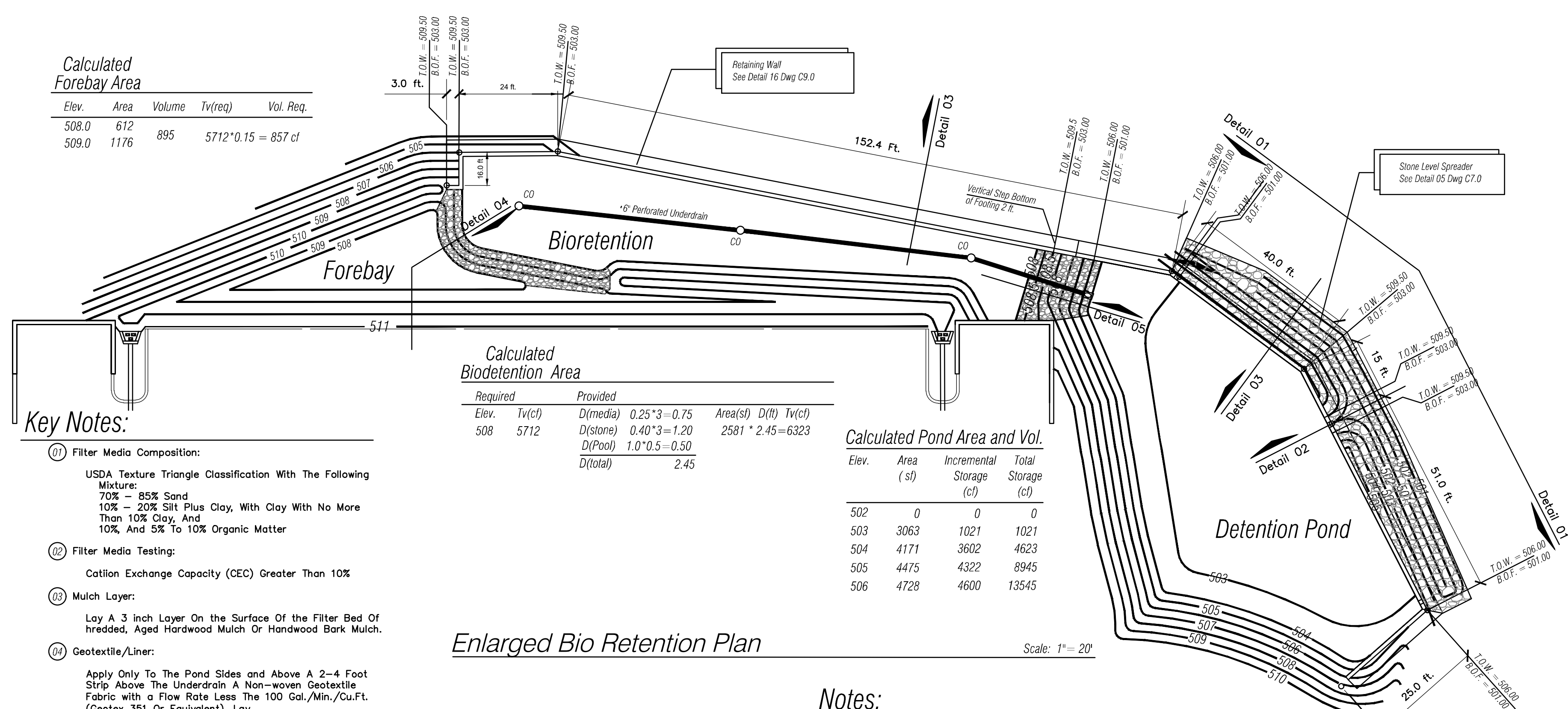

Calculated Bioretention Area

Required Elev.	Tv(cf)	D(media)	D(stone)	D(Pool)	D(total)	Area(st)	D(t)	Tv(cf)
508	5712	0.25*3 = 0.75	0.40*3 = 1.20	1.0*0.5 = 0.50	2.45	2581 * 2.45 = 6323		

Calculated Pond Area and Vol.

Elev.	Area (sf)	Incremental Storage (cf)	Total Storage (cf)
502	0	0	0
503	3063	1021	1021
504	4171	3602	4623
505	4475	4322	8945
506	4728	4600	13545

Key Notes:

- 01 Filter Media Composition:
USDA Texture Triangle Classification With The Following Mixture:
70% - 85% Sand
10% - 20% Silt Plus Clay, With Clay With No More Than 10% Clay, And
10% And 5% To 10% Organic Matter
- 02 Filter Media Testing:
Cation Exchange Capacity (CEC) Greater Than 10%
- 03 Mulch Layer:
Lay A 3 Inch Layer On The Surface Of The Filter Bed Of hredded, Aged Hardwood Mulch Or Hardwood Bark Mulch.
- 04 Geotextile/Liner:
Apply Only To The Pond Sides And Above A 2-4 Foot Strip Above The Underdrain A Non-woven Geotextile Fabric with a Flow Rate Less The 100 Gal./Min./Cu.Ft. (Geotex 351 Or Equivalent). Lay
- 05 Choking Layer:
3 Inch Layer Of Choker Stone #8 Or #89 Clean Washed Gravel), Which Is Laid Over The Underdrain Stone
- 06 Reservoir Layer:
Nine Inch Layer Stone Shall Be #57 Clean And Clean Washed.
- 07 Stone Storage Sump Layer:
Twelve Inches Of Minimum Layer Stone Shall Be Clean Washed #57 Stone.
- 08 Underdrains, Cleanouts, and Observation Wells:
Six Inch Corrugated HDPE or PVC Pipe With 3/8 Inch Perforations At 6 Inches ON Center; Position Each Underdrain On A 1% To 2% Slope Located No More Than 20 Feet From The Next Pipe.
- 09 Retaining Wall See Detail 21 Dwg. C11.0
- 10 Filter Fabric:
Install A Permanent Filter Fabric Liner Along All Exterior Sides Of Excavation Between The Filter Media And The Existing Soil.
Install A Permanent Filter Fabric Directly Above The Underdrain Pipe 2-4 Feet Width And Along The Full Length Of The Pipe.

Notes:

The BioRetention Area Shall Be Protected During Construction and Only Worked with Minimal Size Equipment to Avoid Compacting.
See Landscape Plan LS1.0 for Varieties and Locations of Trees
Compost Shall be Applied for the Top 2 To 4 Inches after Planting Area Preparations are Completed.
All Work Shall Be In Accordance With Metro "Best Management Practice Manual 5, GID-1 And Related References.

Contractor Note:

The Contractor, Engineer, or Owners Representative Shall Notify MWS Development Review At Least 24Hours Prior To The Installation Of The Planting Soil Filter Bed. At The Completion Of Installation, The Above Referenced Person Will collect One Sample Per Bioretention Bed For Analysis and Confirmation Of The Soil Characteristics as Defined By GIP-1, Filter Media and Surface Cover, Section 6.6, Page 29.

Enlarged Bio Retention Plan

Scale: 1" = 20'

Notes:

4000 P.S.I. Conc. At 28 Days Placed On 95% Compacted Subbase.
Reinforcing Steel Grade 60 Deformed Located as Detailed.
All Edges Of Exposed Surfaces To Be Chamfered One Inch.
All Edges Of Exposed Surfaces To Be Chamfered One Inch

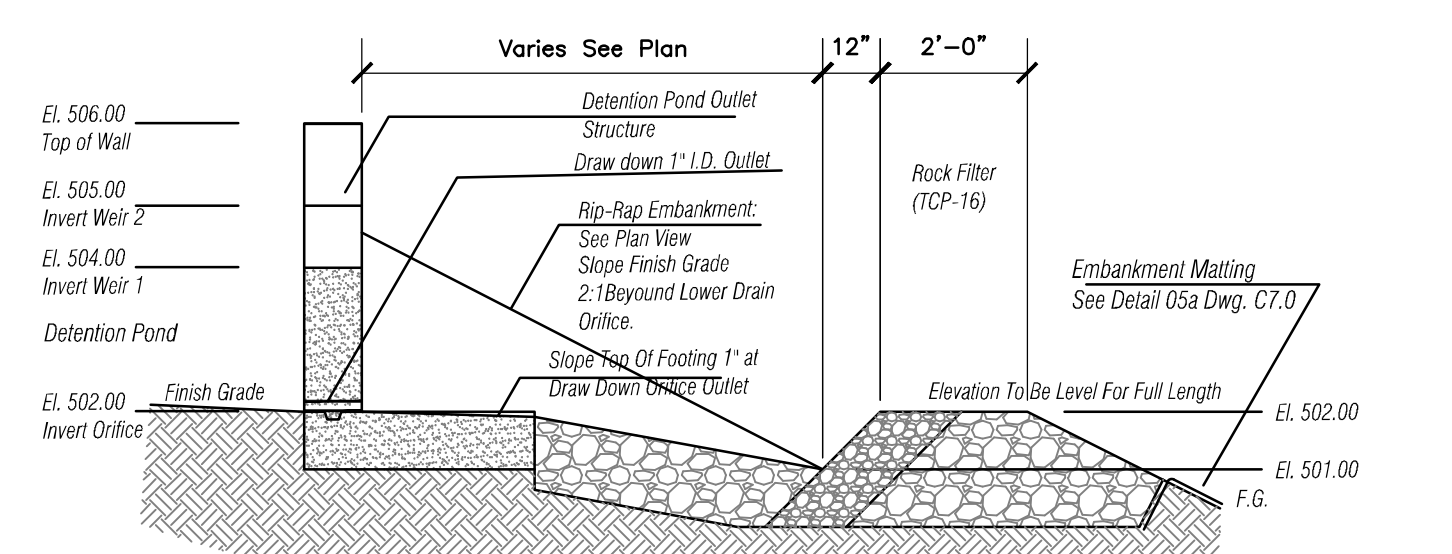

02 Detail
Section Through Detention Outlet Structure Retaining Wall

N.T.S.

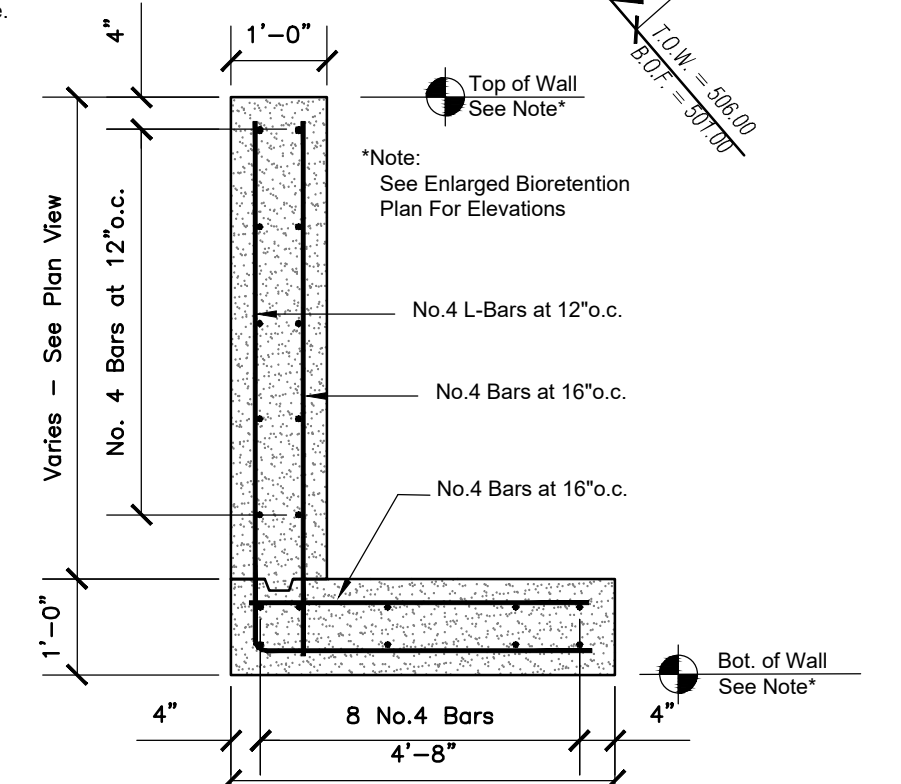

03 Detail
Section Typical For Retaining Wall Structures

N.T.S.

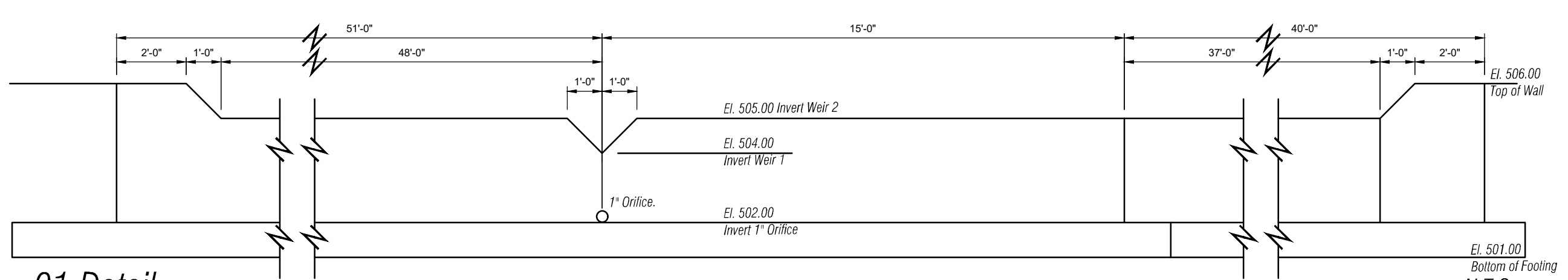

01 Detail
Elevation of Partial Developed View Of The Detention Pond Outlet Structure

N.T.S.

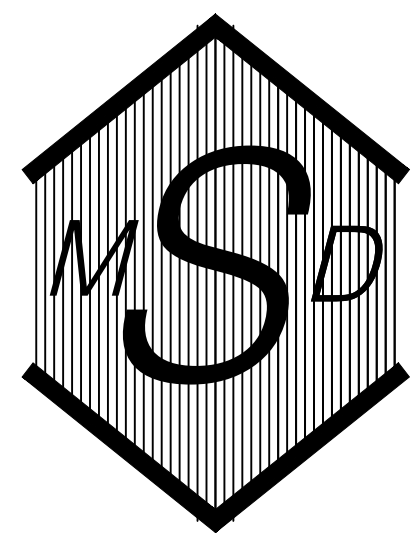

MURRAY D. SHANKLIN, PE
P.O. BOX 9
PORTLAND, TN 37148
615.512.2811
Email:
mshanklin@ellsouth.net

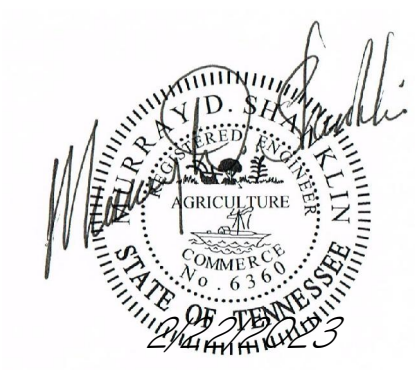

Drawn MDS
Checked By MDS
Project No. 16 Robert Berard
Date 11/3/2018

Revised 08/21/2016
Revised 07/03/2016
Revised 03/08/2019
Revised 07/15/2019
Revised 08/03/2020

A New Multiply Family Home Complex
Apartment Concept
1636 Lebanon Pike
Nashville, Tennessee
Parcel No. 09400005000 and 09400004900

SHEET TITLE:

Bio Retention Details

SHEET NO.

C9.0

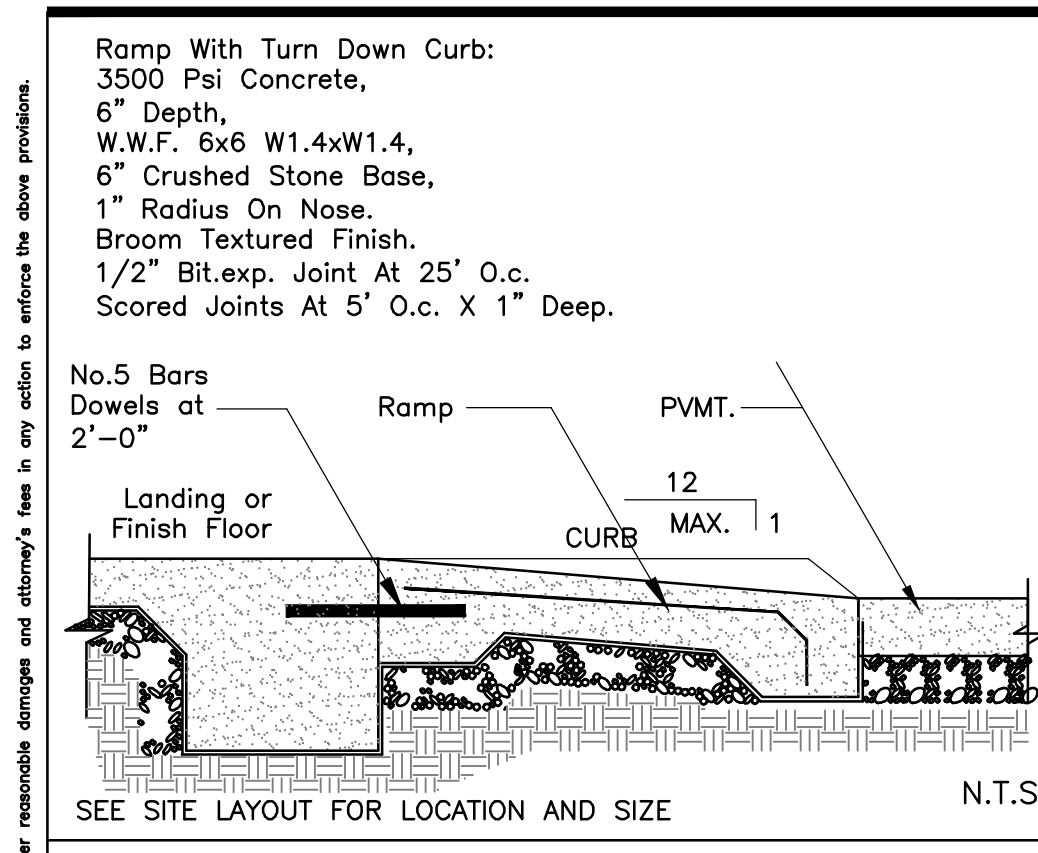

01 Typ. Concrete Ramp

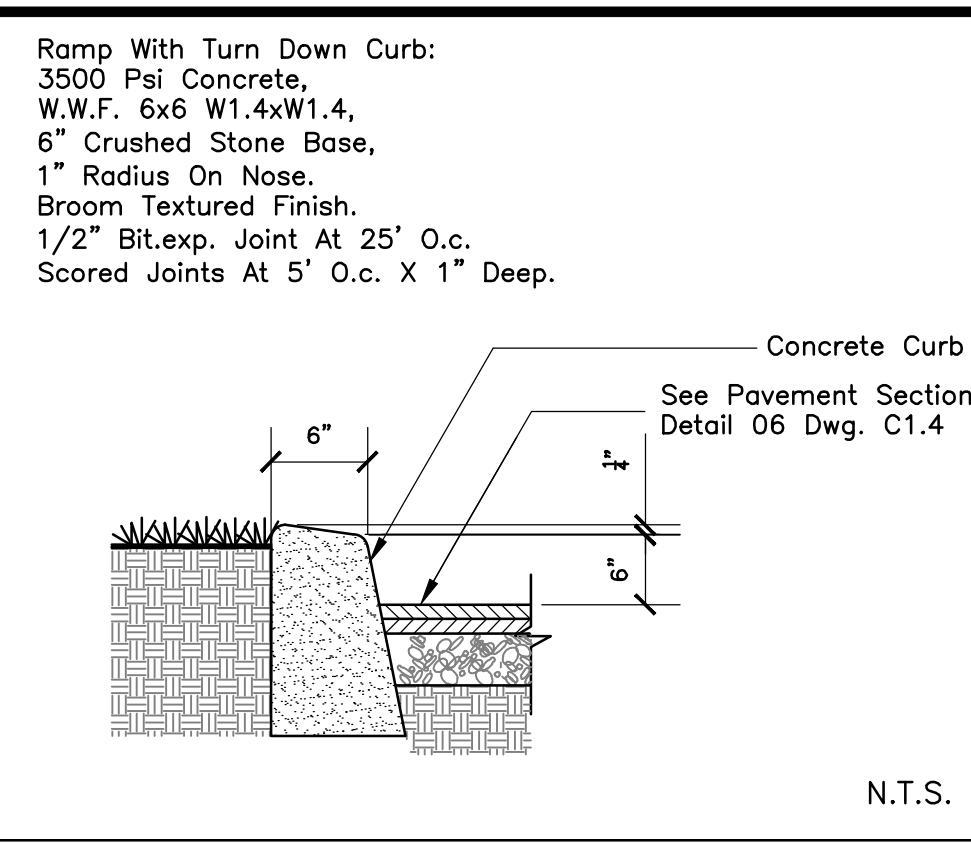

02 Typical Curb Detail

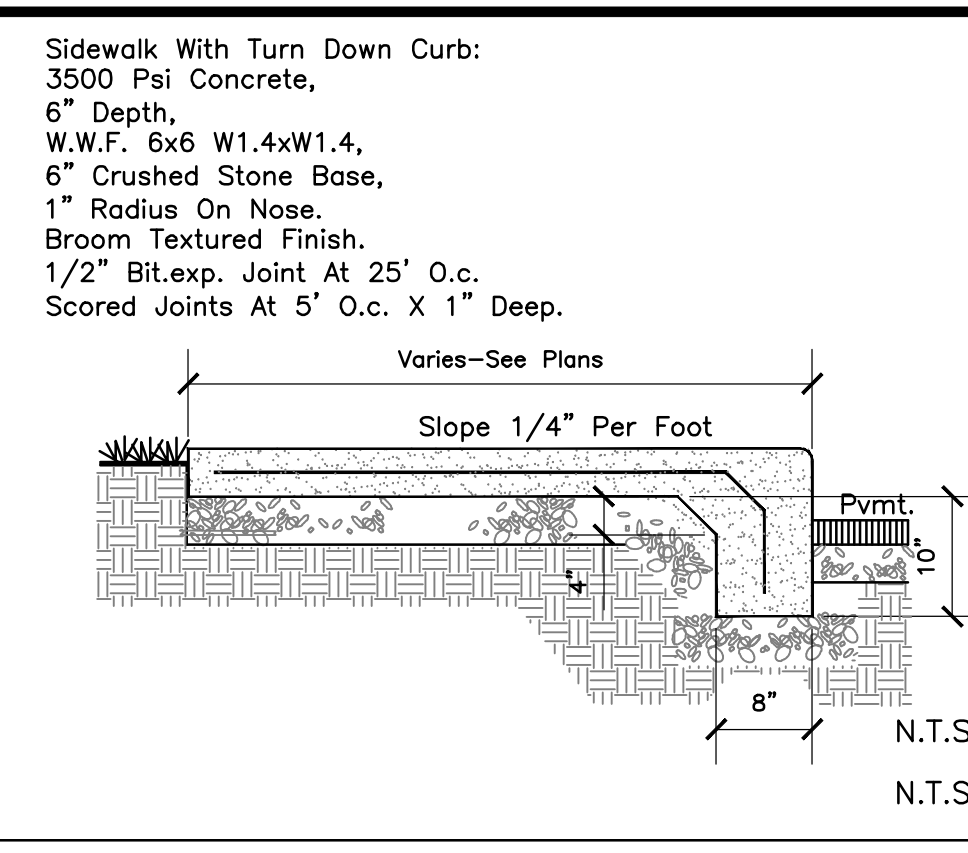

03 Conc. Walk W/ Turndown

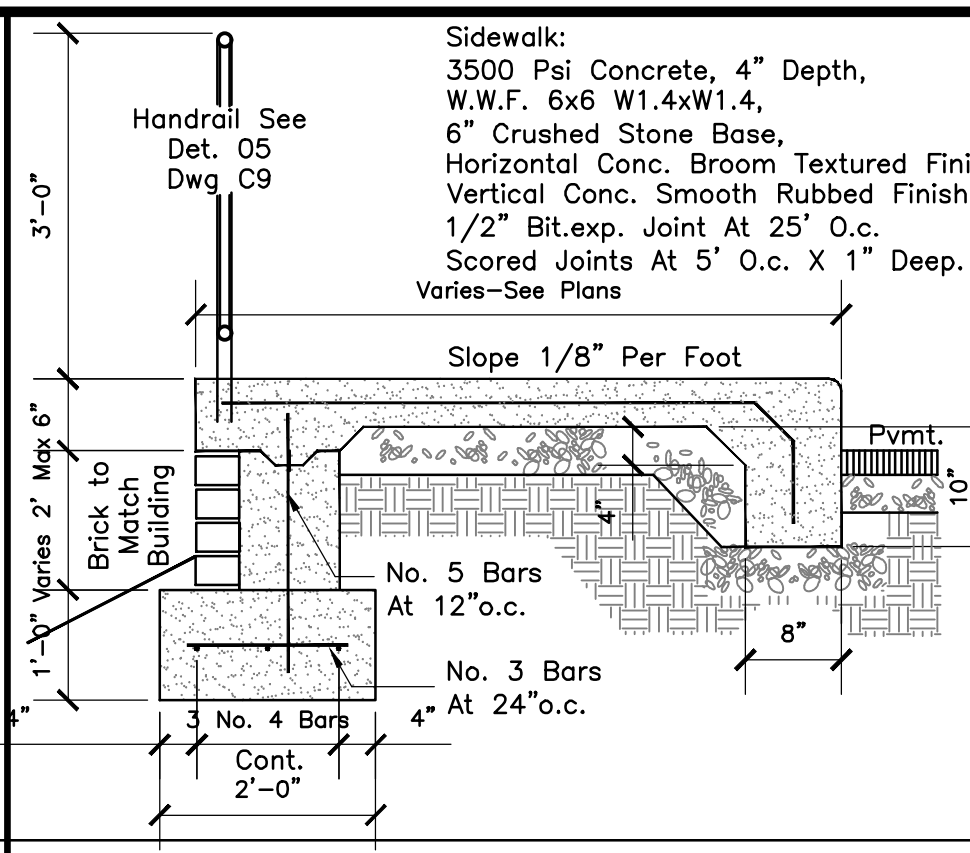

04 Conc. Walk W/Handrail

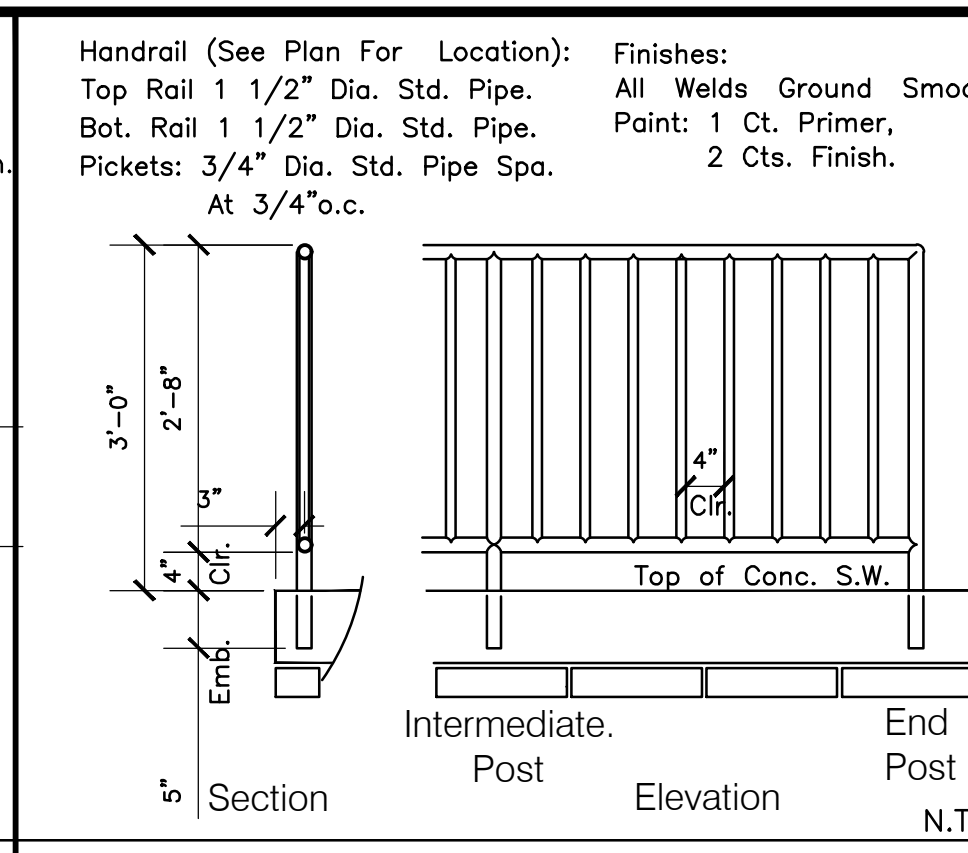

05 Detail Metal Handrail

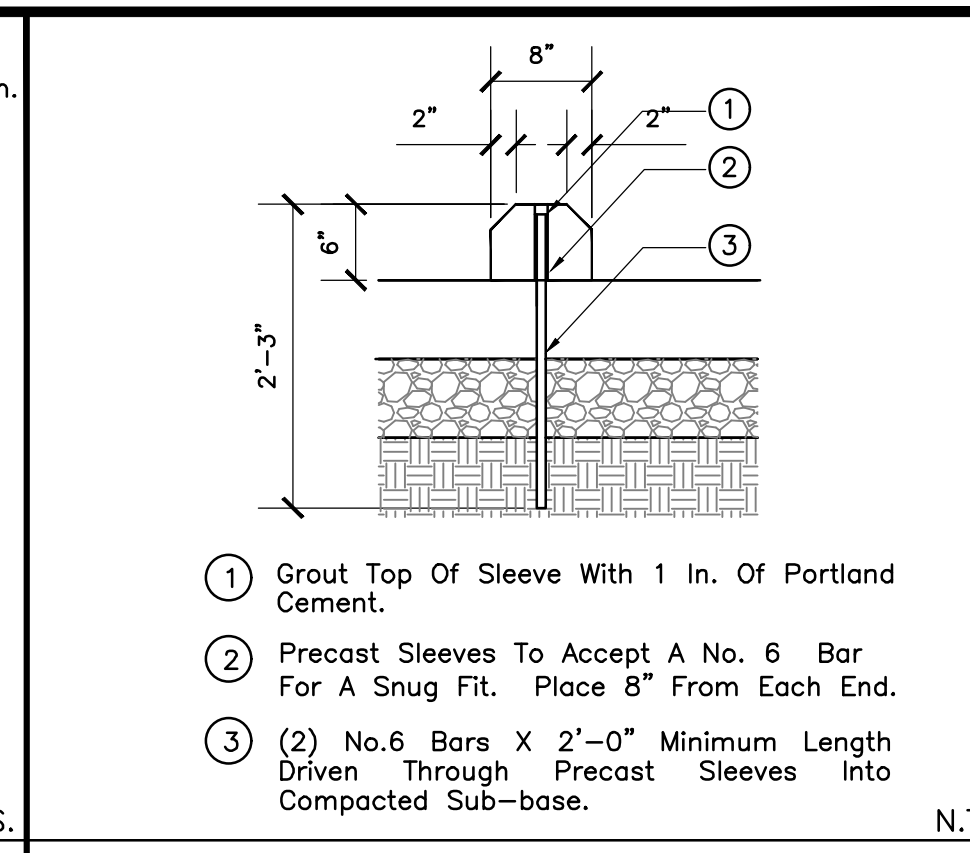

06 Wheelstop Detail

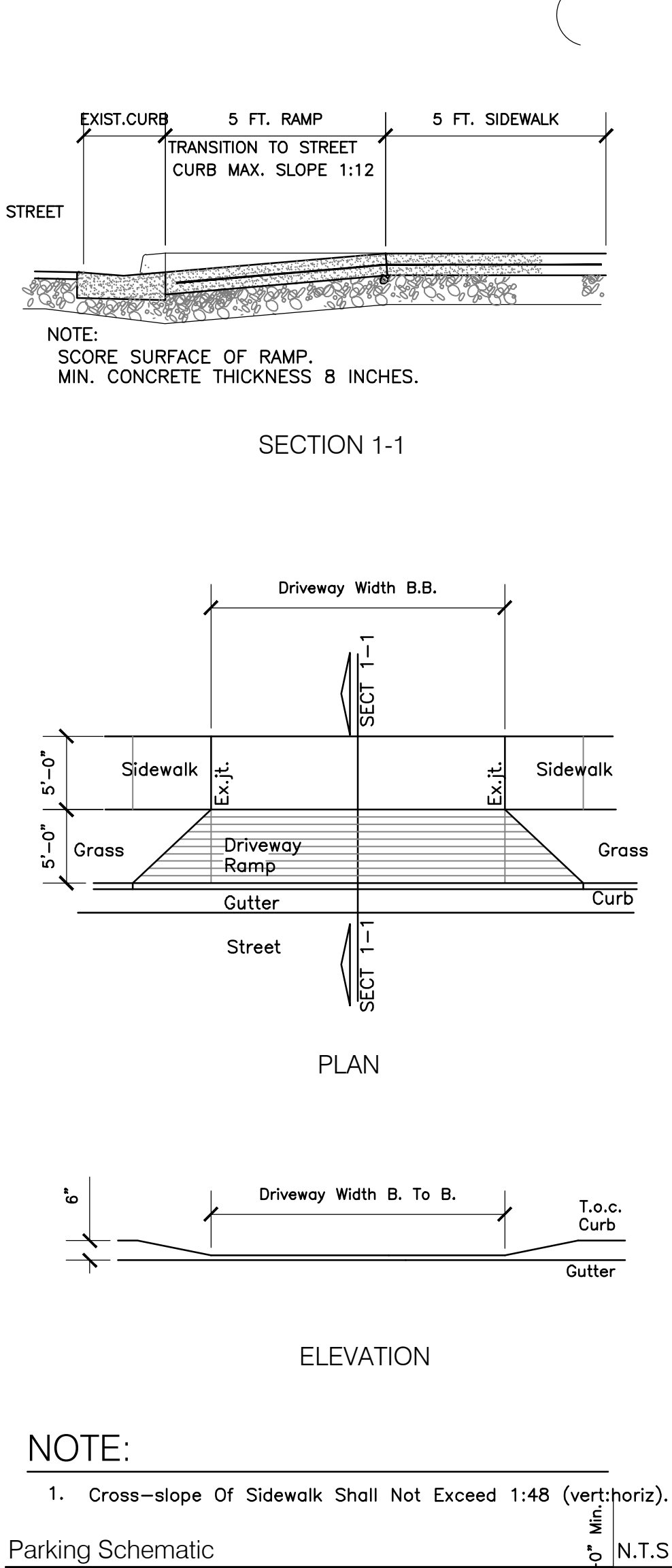

07 Driveway Entrance Detail

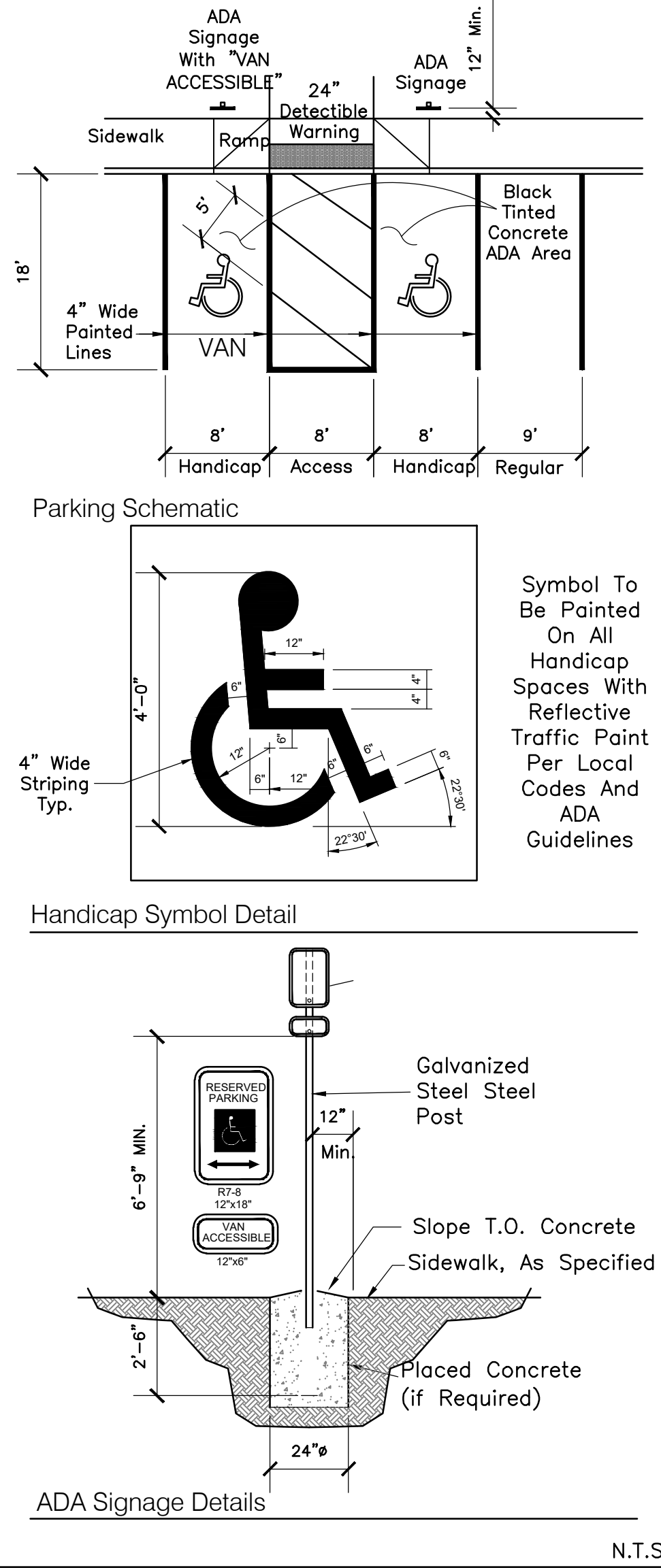

08 Site Handicap Details

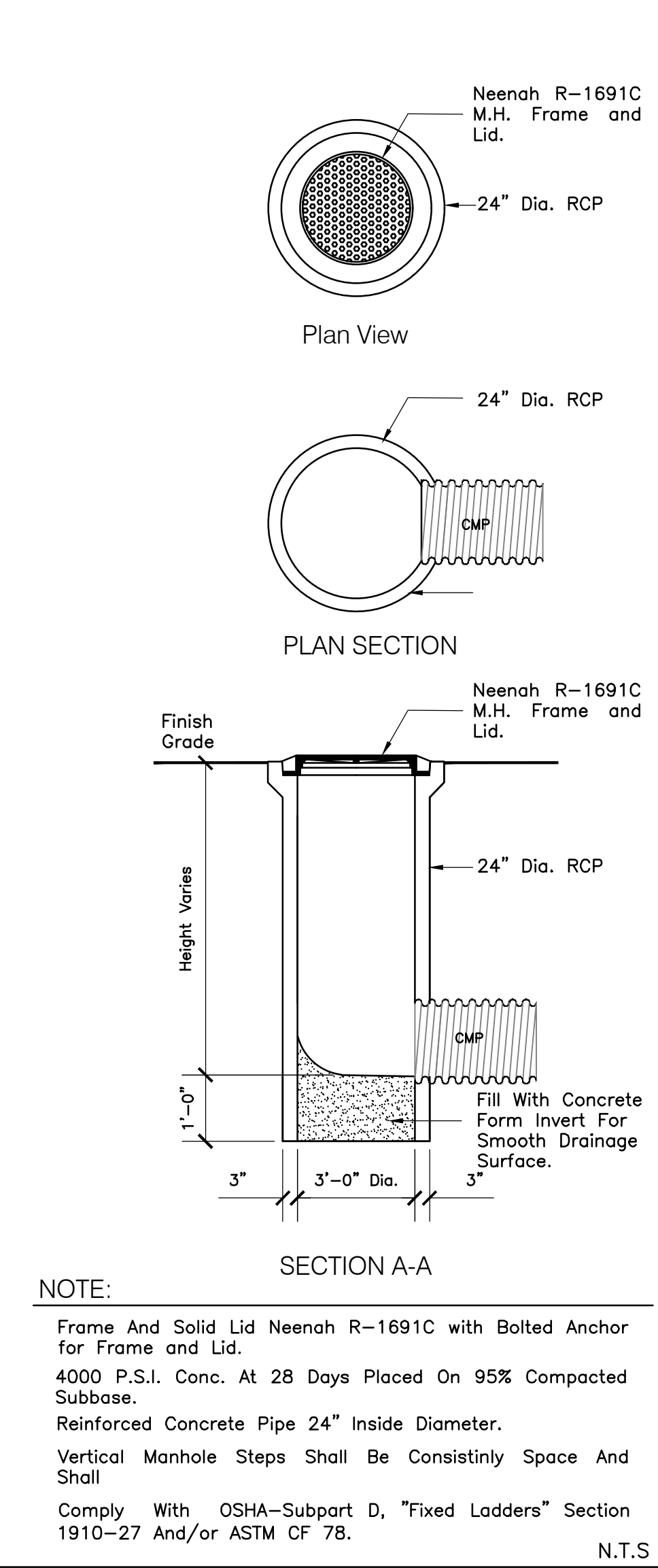

09 Junction Box

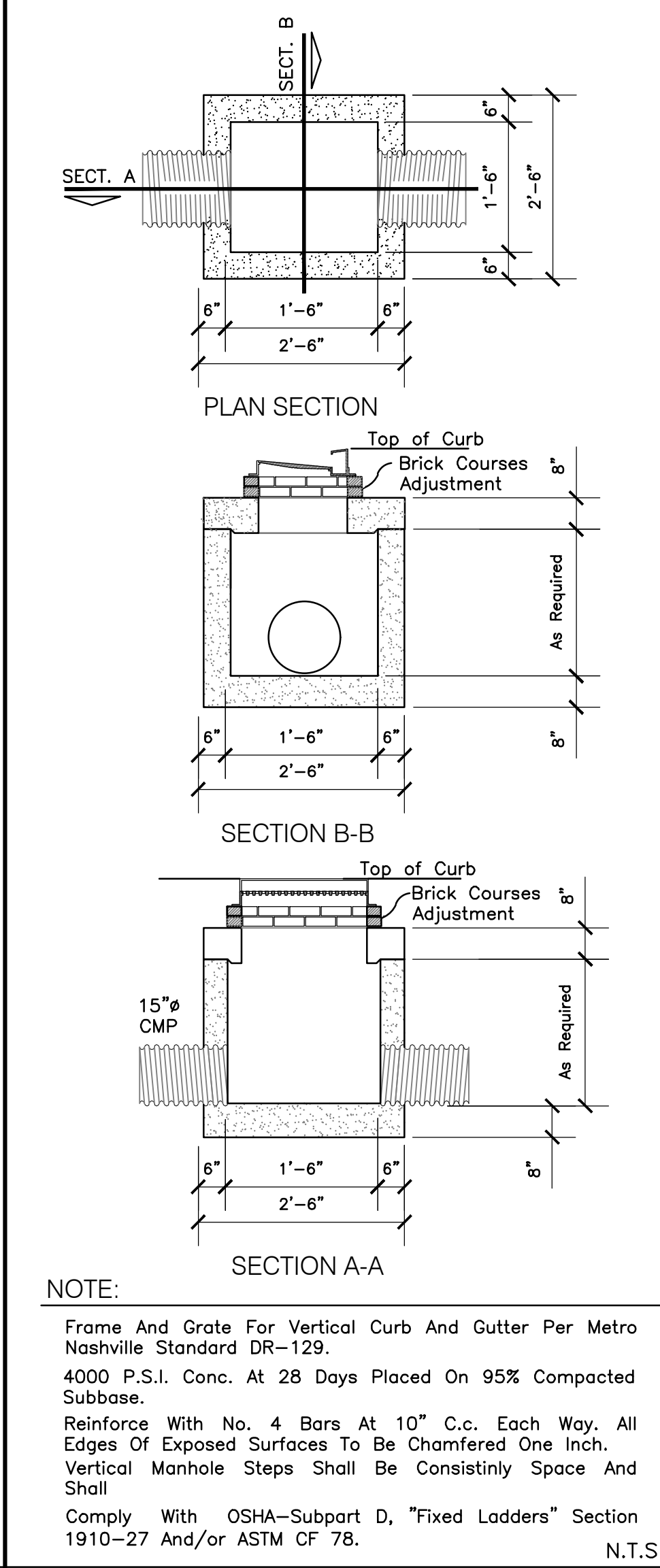

10 Curb Drain

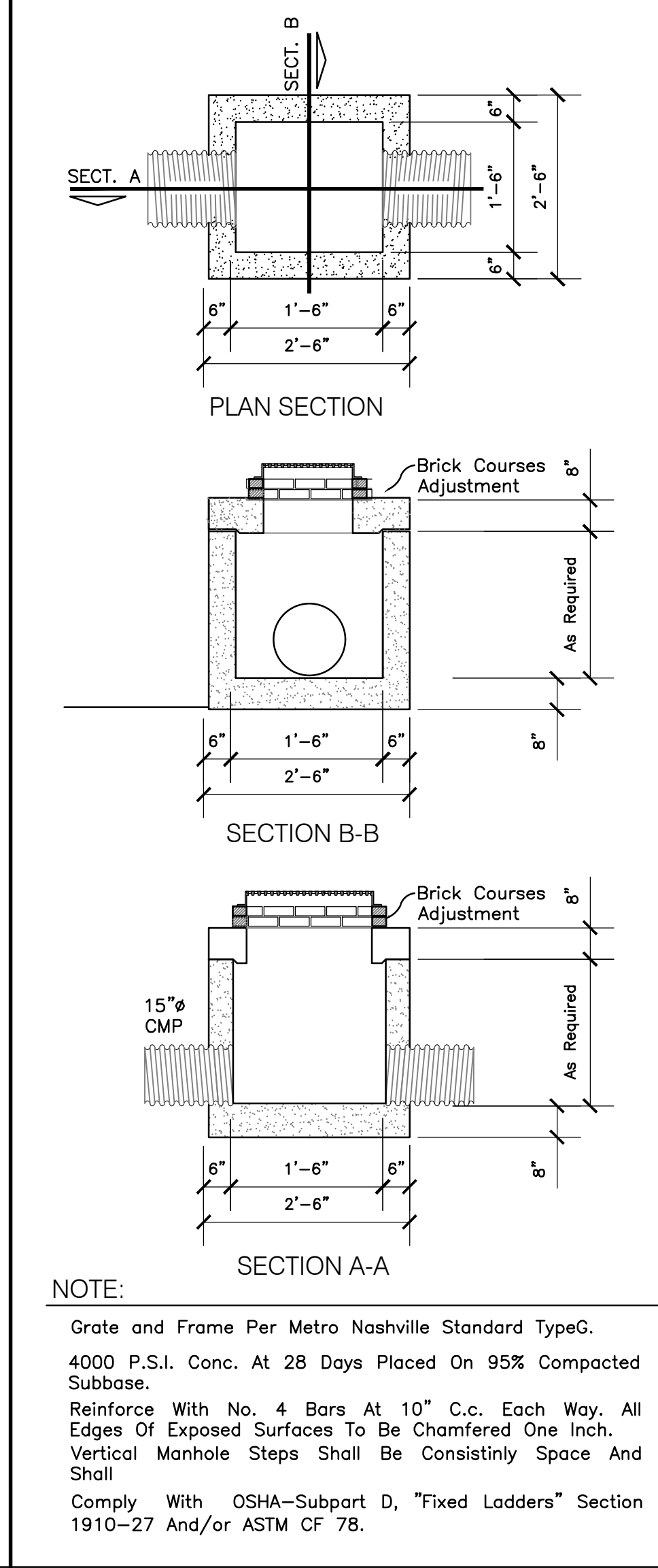

11 Area Drain

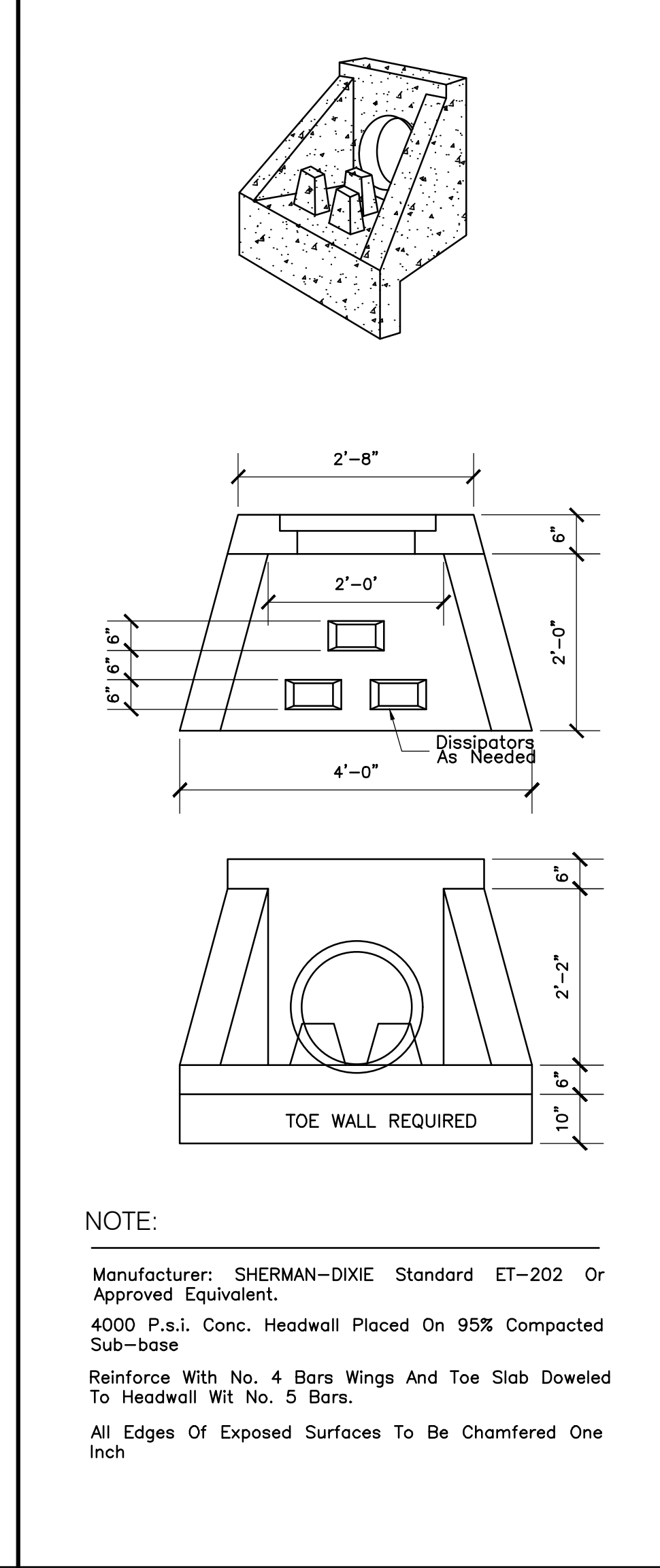

12 Headwall Details (Precast)

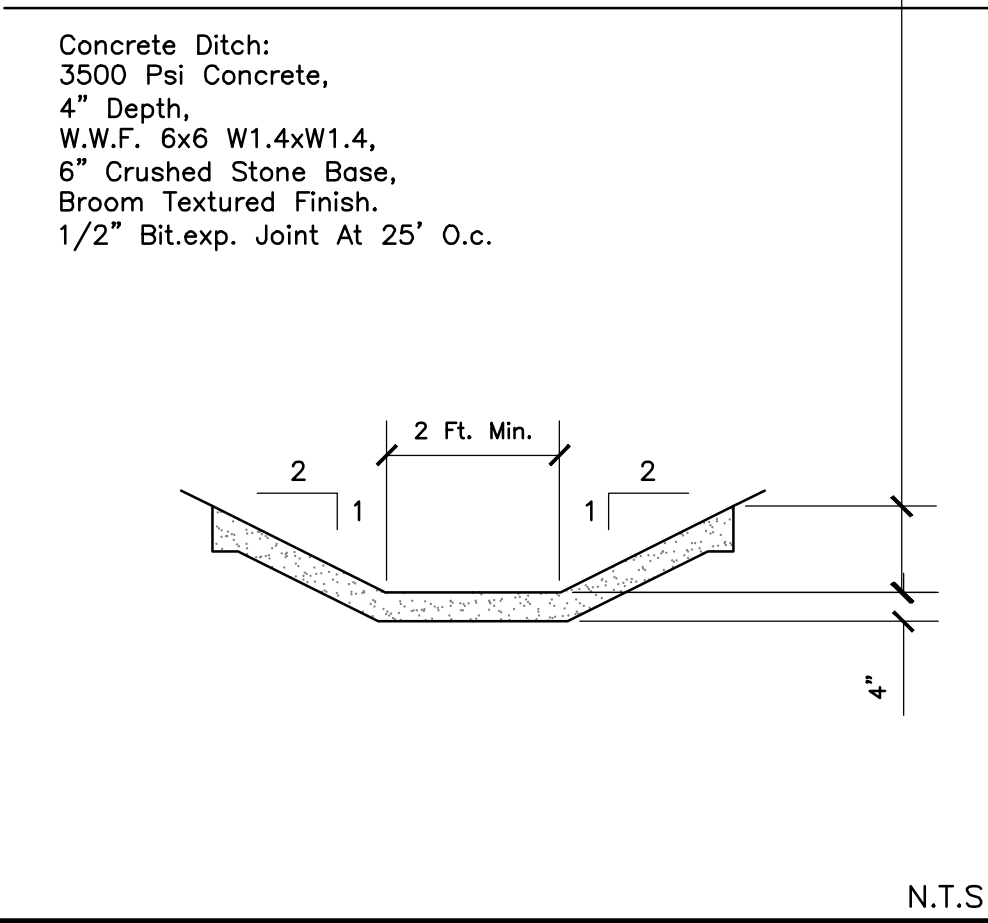

13 Typ. Concrete Ditch Section

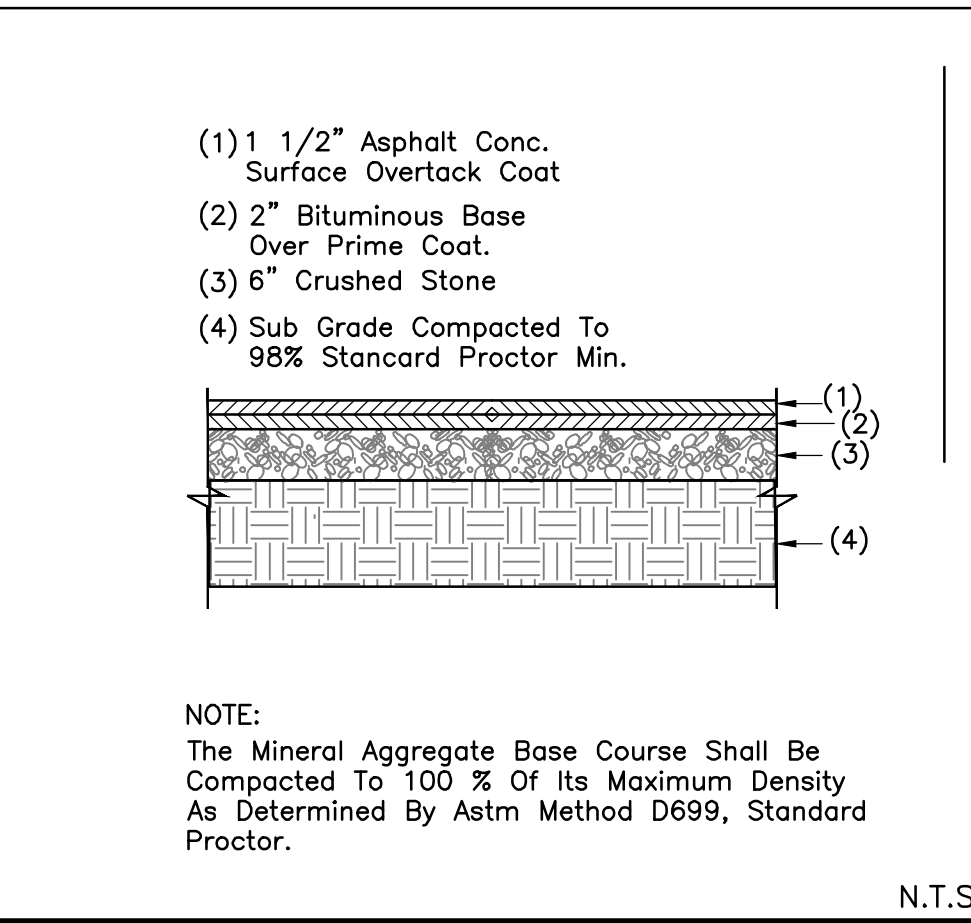

14 Pavement Section Detail

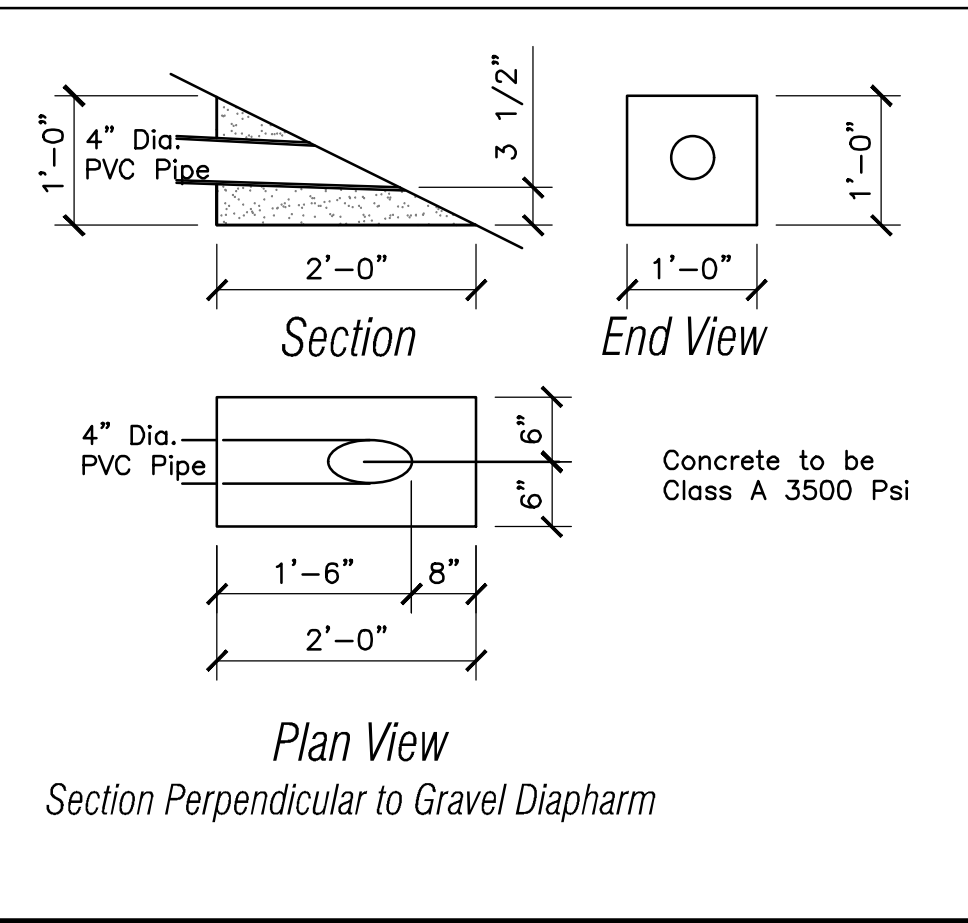

15 Outlet Pipe End Protection

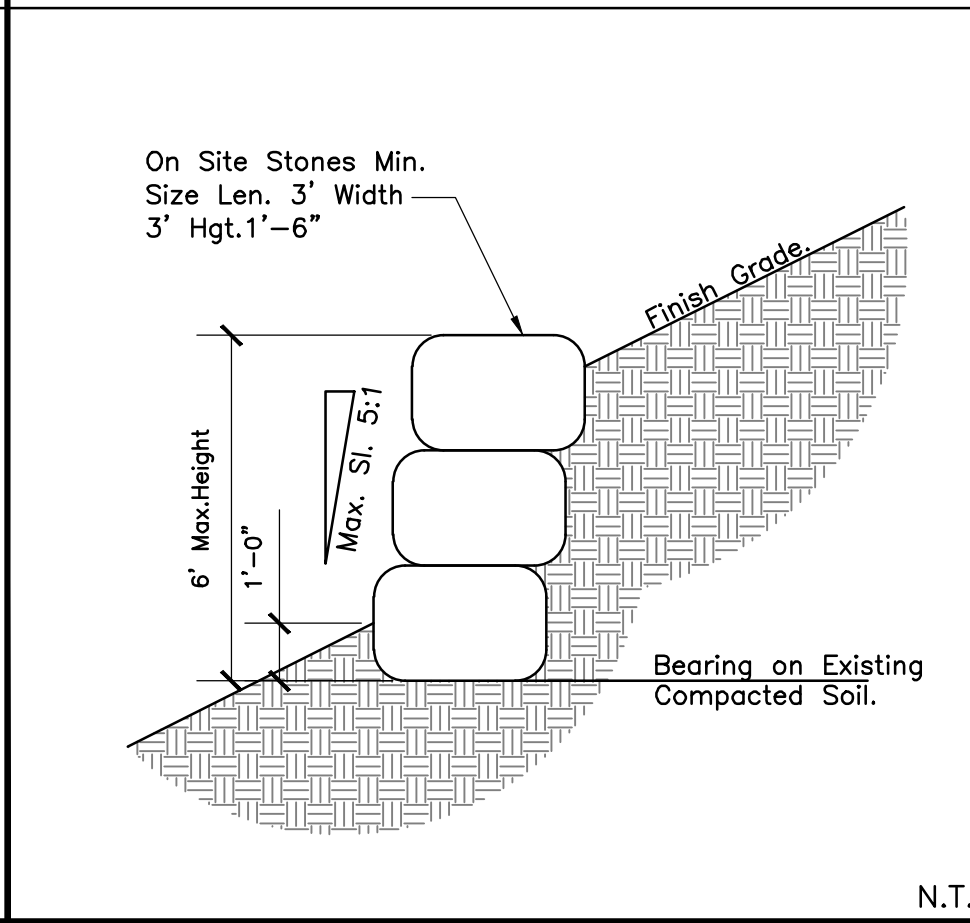

16 Typ. Stone Retaining Wall Section

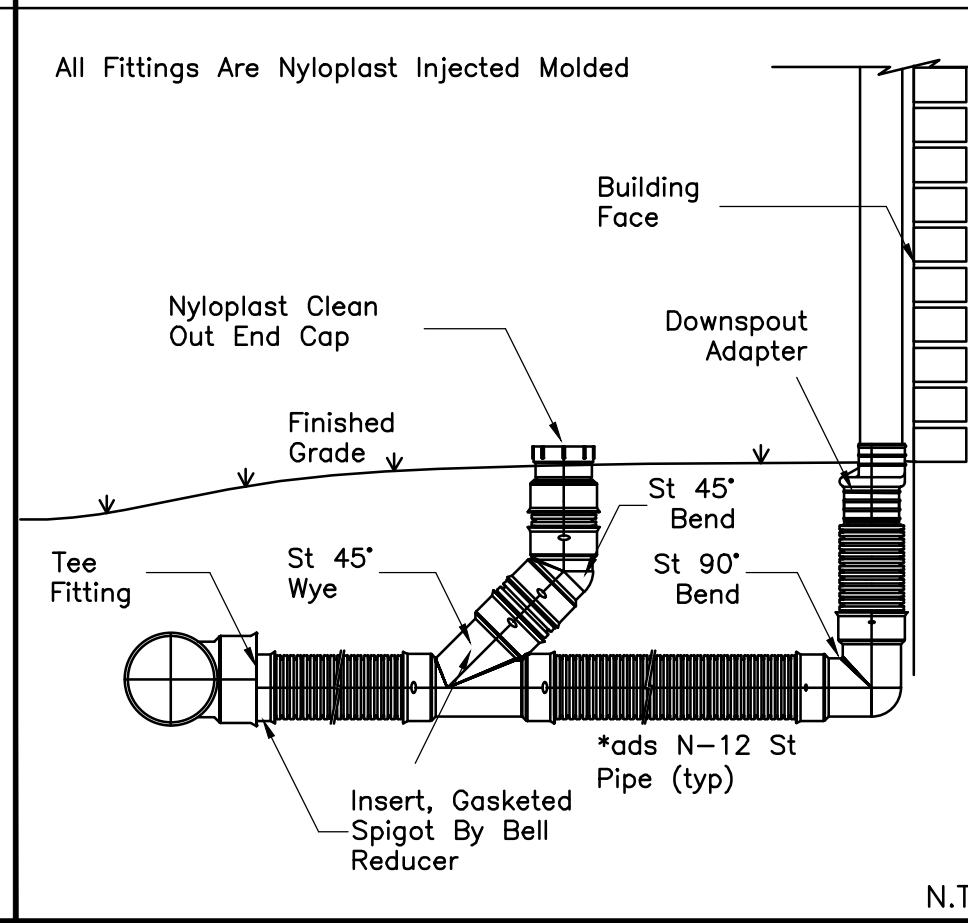

17 Roof Drain Detail With Cleanout

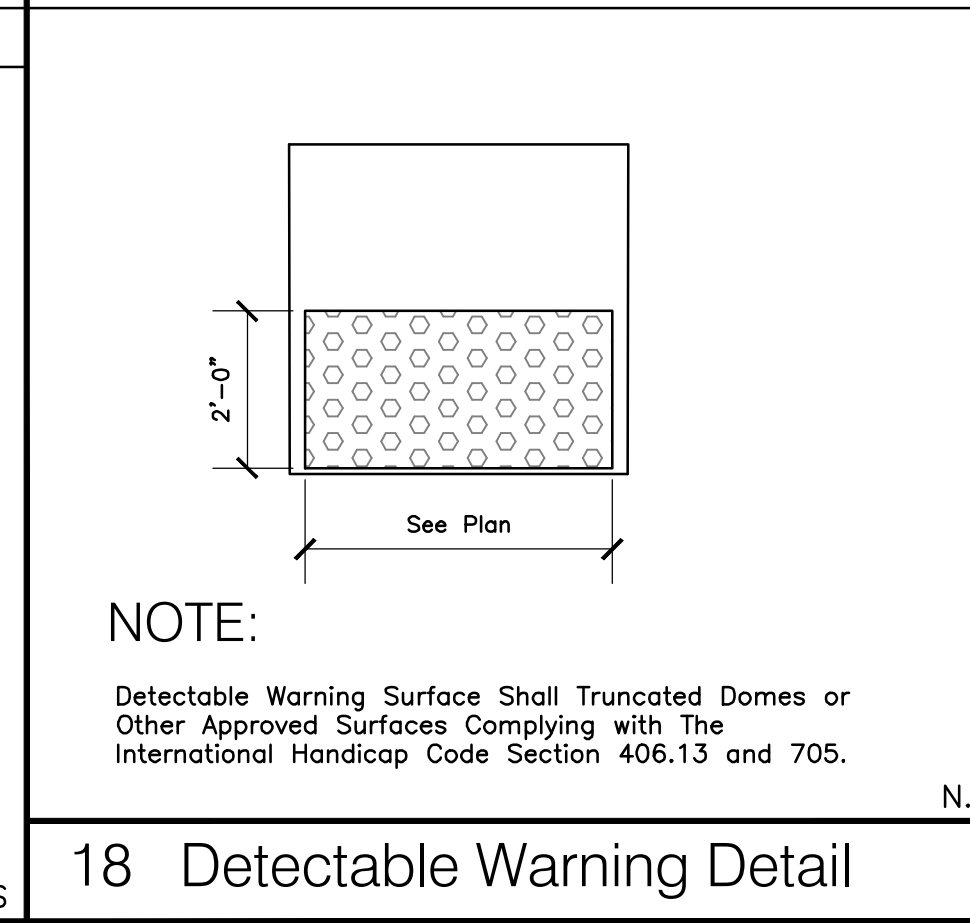

18 Detectable Warning Detail

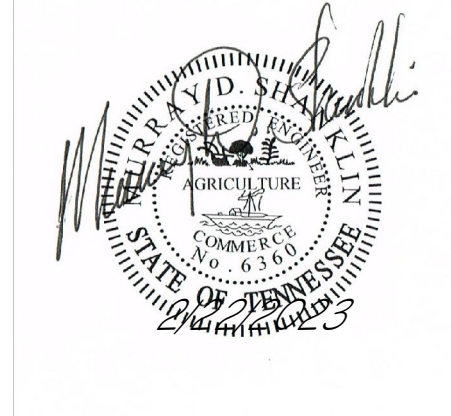
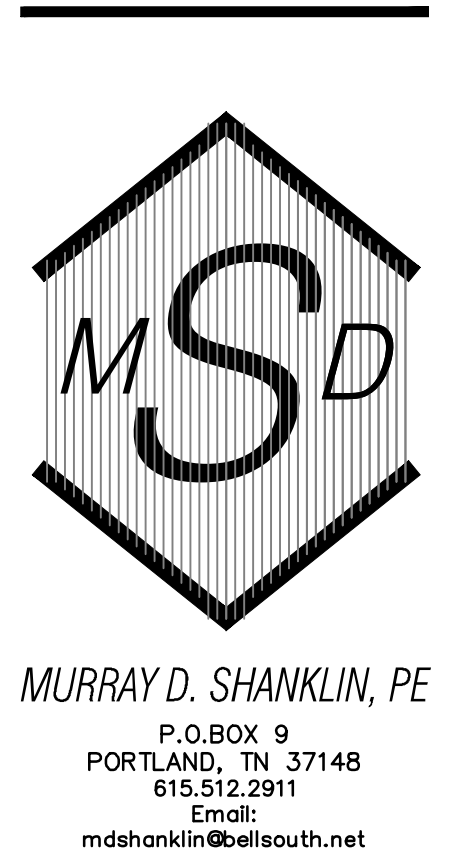

Drawn MDS
 Checked By MDS
 Project No. 16 ROBERT BERARD
 Date 06/21/2016

Revised 06/21/2016
 Revised 07/03/2016
 Revised 03/08/2019

A New Multiply Family Home Complex
 Apartment Concept
 1636 Lebanon Pike
 Nashville, Tennessee
 Parcel No. 09400005000 and 09400004900

SHEET TITLE:
 STANDARD SITE DETAILS

SHEET NO.
 C10.0

These plans and specifications and all copies hereof, on the side and exclusive property of MURRAY D. SHANKLIN, P.E. Any reproduction, publication, exhibition, or use of all or any part hereof without the express written consent of MURRAY D. SHANKLIN, P.E. is strictly prohibited. Anyone violating these plans is deemed to agree to the above and that MURRAY D. SHANKLIN, P.E. shall be entitled to recover reasonable damages and attorney's fees in any action to enforce the above provisions.

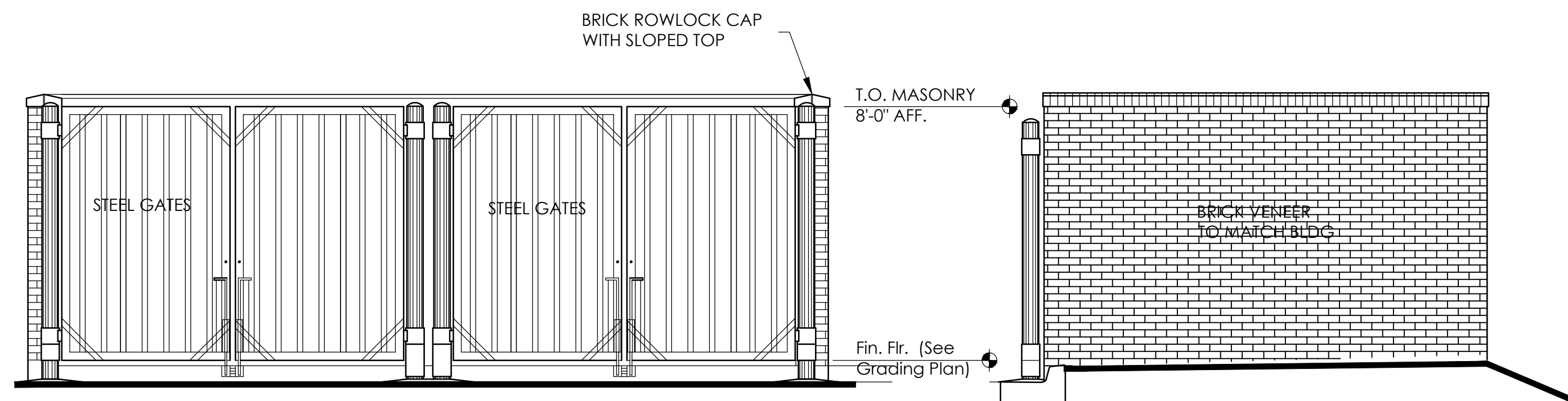

FRONT ELEVATION

RIGHT ELEVATION

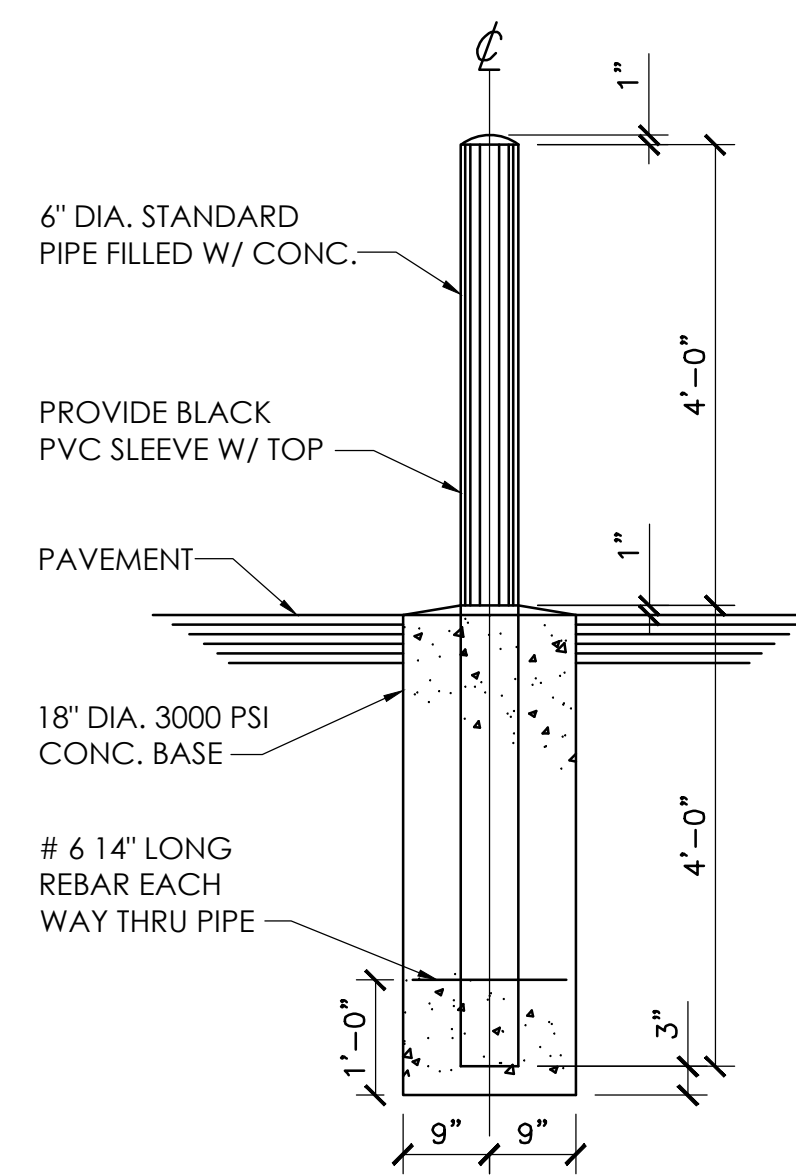

STEEL BOLLARD DETAIL

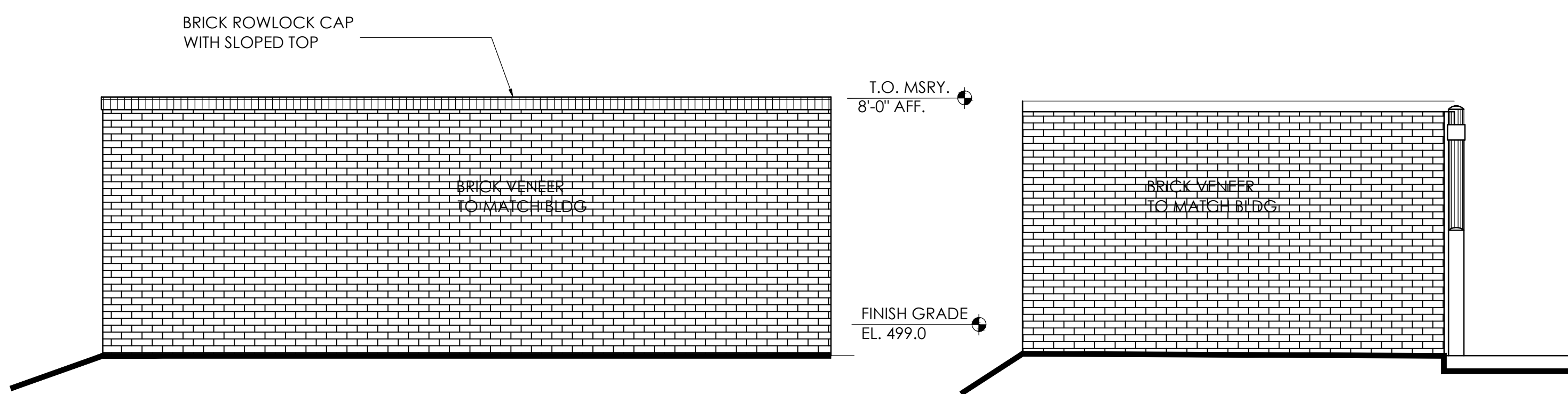

REAR ELEVATION

LEFT ELEVATION

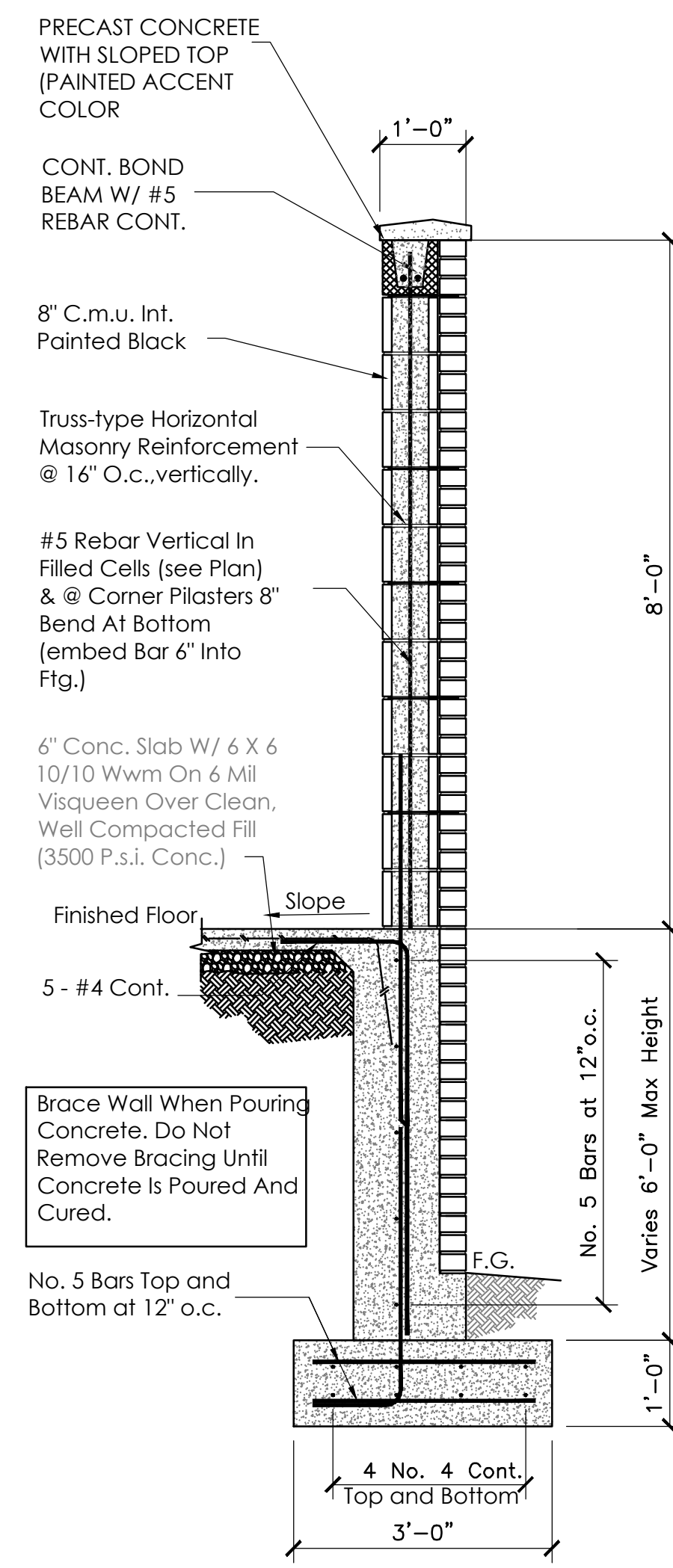

TYPICAL WALL SECTION

N.T.S.

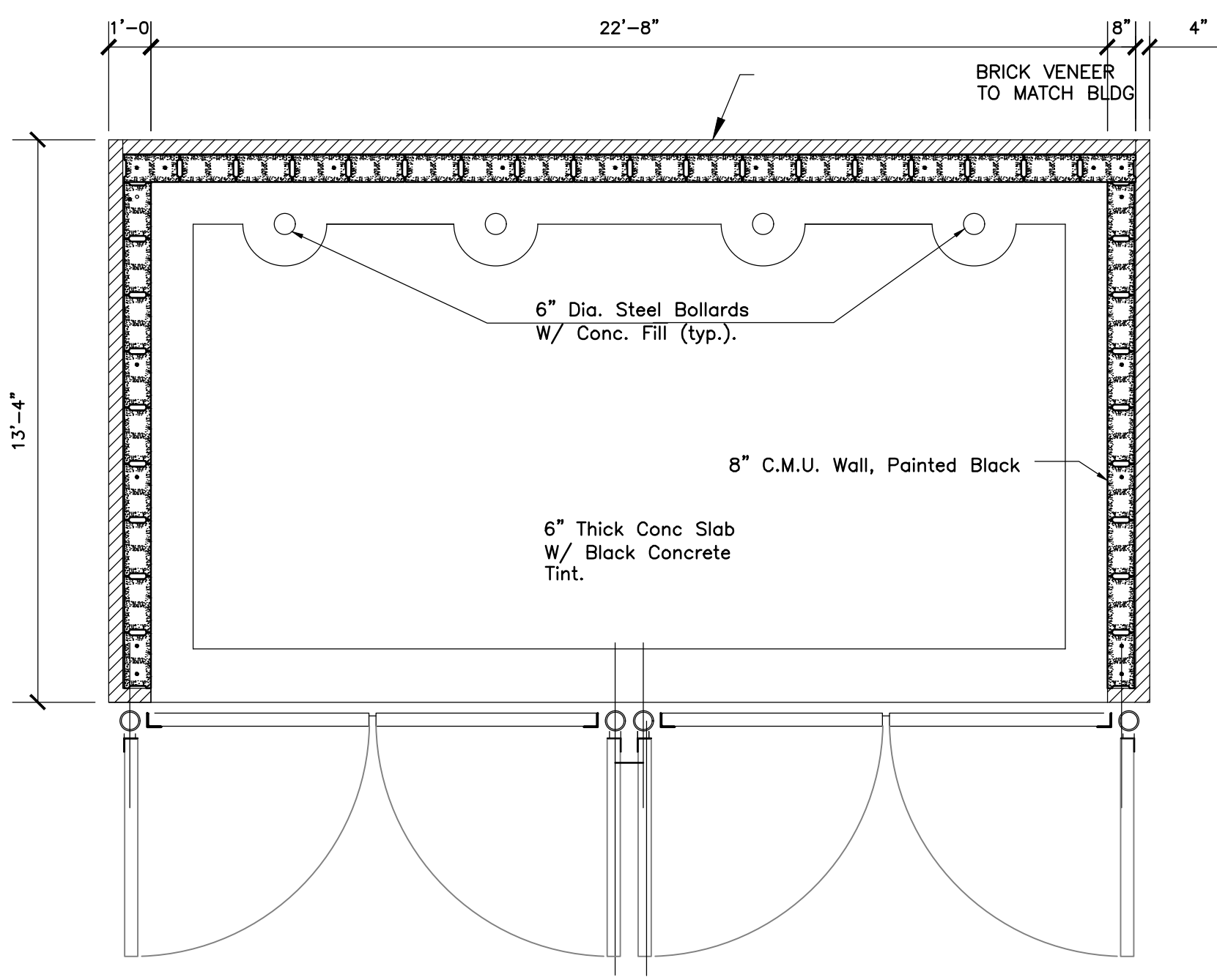

DUMPSTER AND STORAGE AREA PLAN

N.T.S.

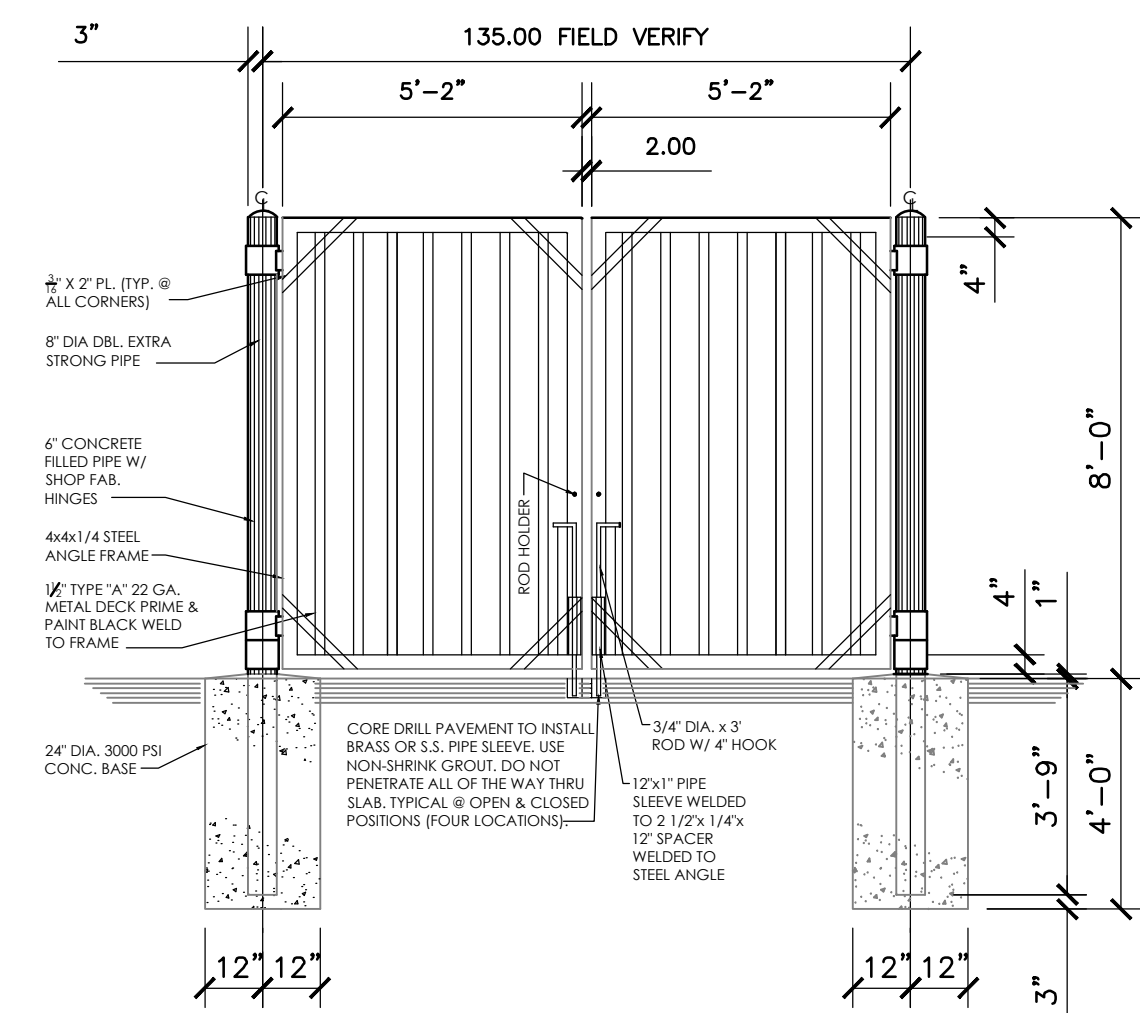

DUMPSTER GATE DETAILS

N.T.S.

(REFER TO ARCHITECTURAL PLANS FOR EXACT BUILDING DIMENSIONS AND DETAILS)

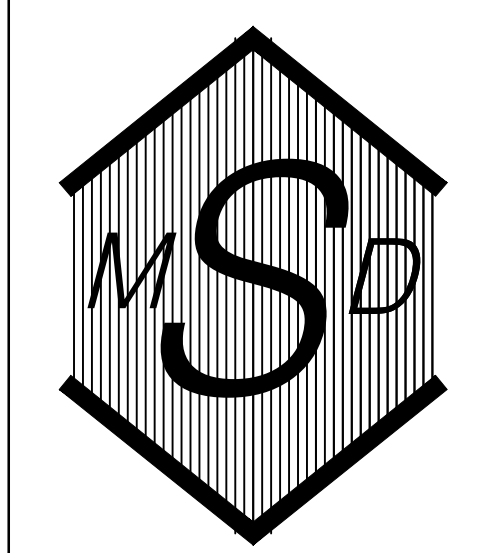

MURRAY D. SHANKLIN, PE
P.O. BOX 9
PORTLAND, TN 37148
615.512.2911
Email:
mdshanklin@ellsouth.net

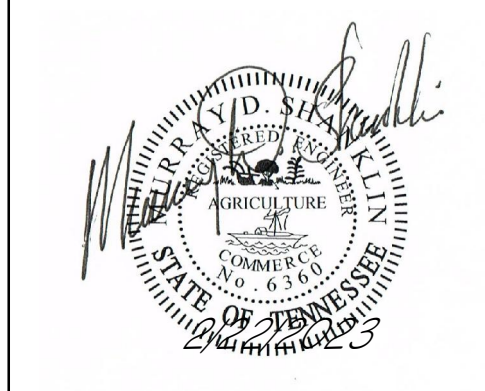

Drawn	MDS
Checked By	MDS
Project No.	16 ROBERT BERARD
Date	07/15/2019

Revised 06/21/2016
Revised 07/03/2016

A New Multiply Family Home Complex
Apartment Concept
1636 Lebanon Pike
Nashville, Tennessee
Parcel No. 09400005000 and 09400004900

SHEET TITLE:
Standard Site Details

SHEET NO.
C11.0

These plans and specifications are of copies hereof, are the sole and exclusive property of MURRAY D. SHANKLIN, P.E. Any reproduction, publication, exhibition, or use of all or any part hereof without the express written consent of MURRAY D. SHANKLIN, P.E. is strictly prohibited. Anyone viewing these plans is deemed to agree to the above and that MURRAY D. SHANKLIN, P.E. shall be entitled to recover reasonable damages and attorney's fees in any action to enforce the above provisions.

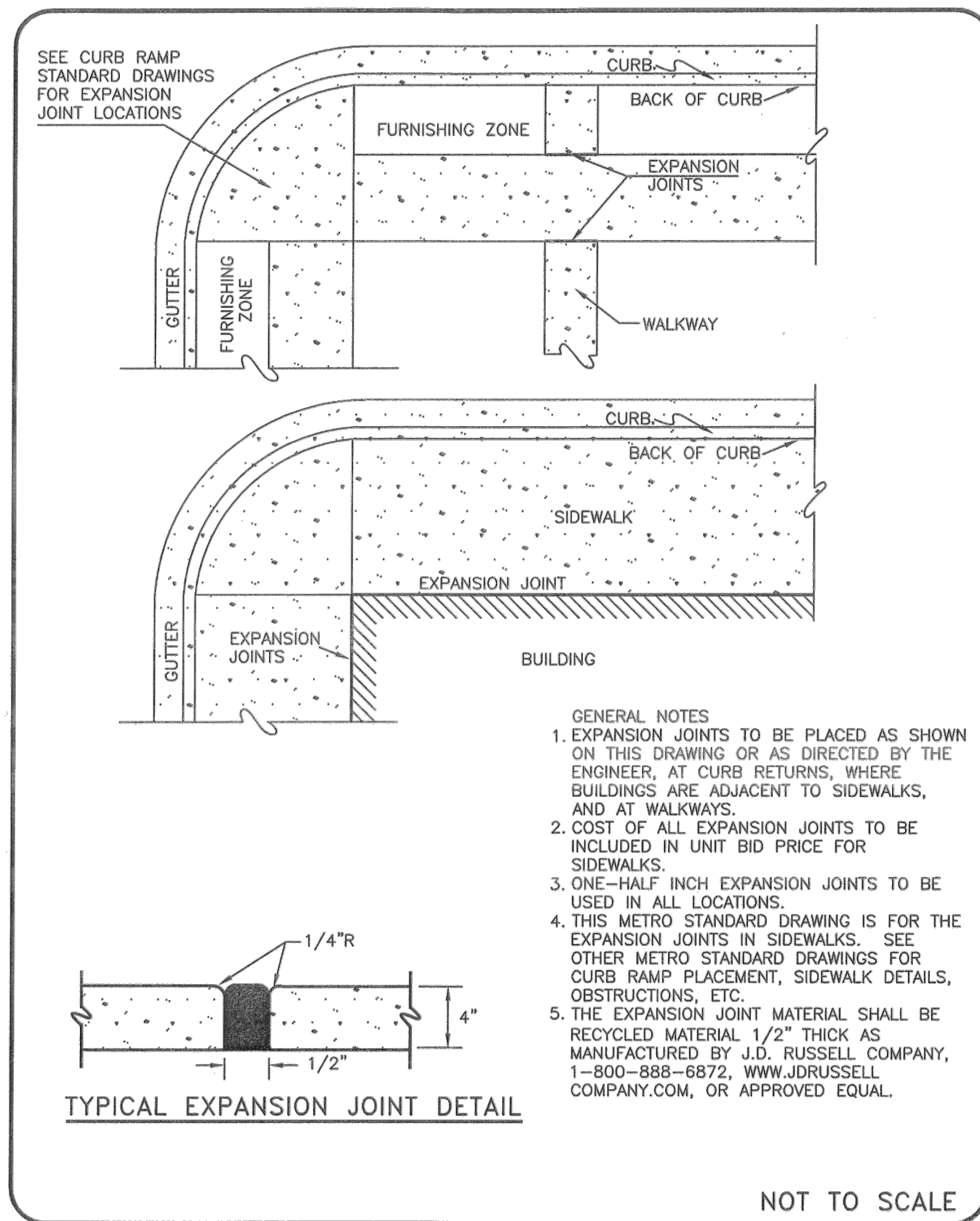

METROPOLITAN GOVERNMENT OF NASHVILLE AND DAVIDSON COUNTY DEPARTMENT OF PUBLIC WORKS	STANDARD EXPANSION JOINT FOR CONCRETE SIDEWALK	DWG. NO. ST-209
DIR. OF ENG.: <i>Mark May</i>	DATE: <i>5/12/03</i>	REVISED: 03/01/02 REVISED: 05/02/03 REVISED:

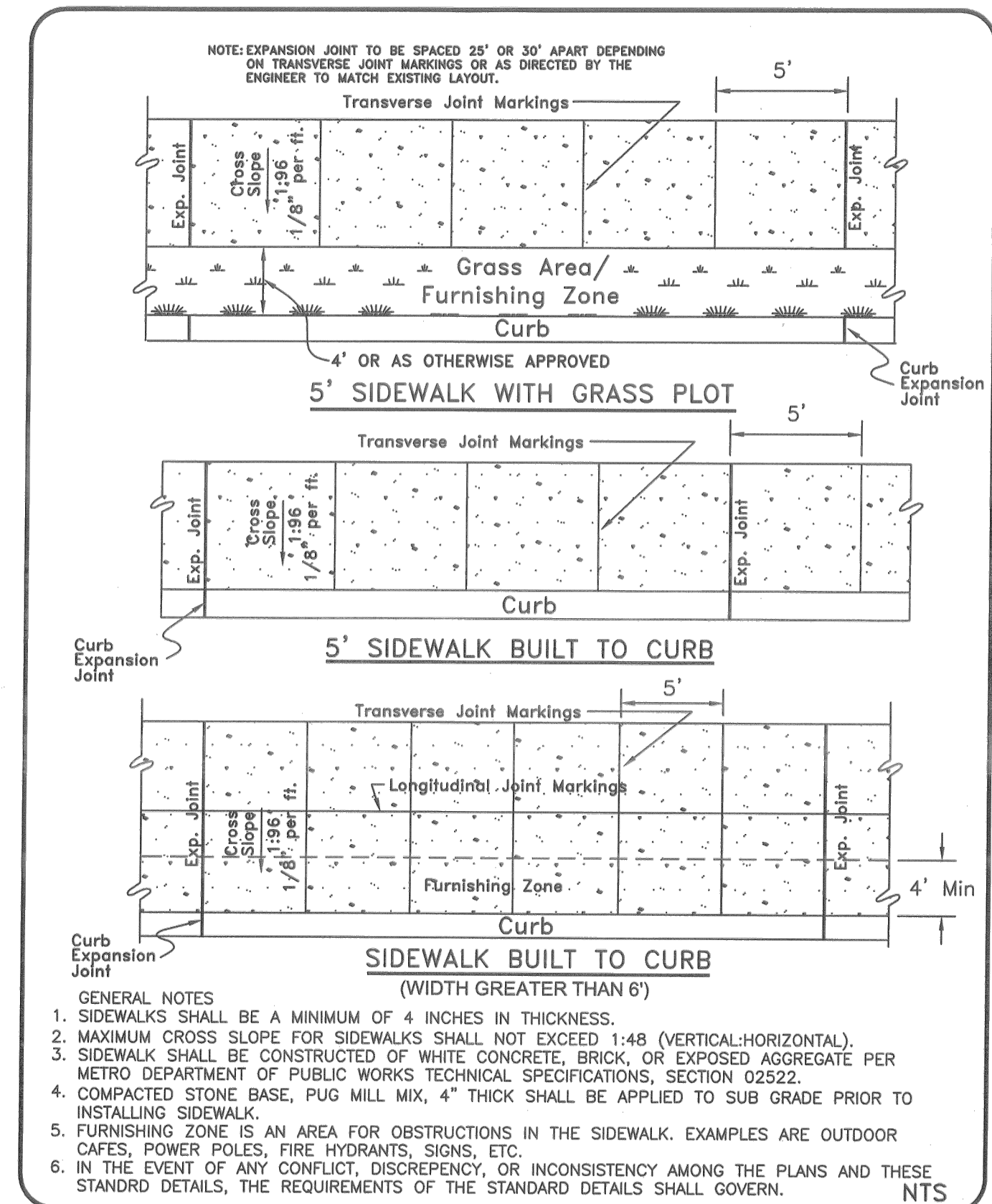

METROPOLITAN GOVERNMENT OF NASHVILLE AND DAVIDSON COUNTY DEPARTMENT OF PUBLIC WORKS	SIDEWALK CONSTRUCTION	DWG. NO. ST-210
DIR. OF ENG.: <i>Mark May</i>	DATE: <i>7/15/04</i>	REVISED: 05/02/03 REVISED: 11/24/03 REVISED: 06/23/04

NOTES:

- CURB RAMPS SHALL BE PROVIDED TO ALLOW ALL USERS TO MAKE THE TRANSITION IN GRADE FROM THE STREET TO THE SIDEWALK.
- CURB RAMPS SHALL BE CONSTRUCTED TO THE DIMENSIONS AND FINISHED ELEVATIONS AS SPECIFIED IN THE PLANS AND/OR CONTRACT DOCUMENTS AND SHALL ALSO CONFORM TO THE REQUIREMENTS OF THE AMERICANS WITH DISABILITIES ACT. SURFACE TEXTURE OF THE CURB RAMP SHALL BE STABLE, FIRM, AND SLIP-RESISTANT. THE SURFACE SHALL BE COARSE BROOMED FINISH TRANSVERSE TO THE SLOPE OF THE RAMP. CARE SHALL BE TAKEN TO ASSURE AN UNIFORM GRADE ON THE CURB RAMP. LONGITUDINAL AND TRANSVERSE JOINT MARKINGS SHALL NOT BE ALLOWED ON THE LANDINGS OR RAMPS.
- DRAINAGE AND UTILITY STRUCTURES SHALL NOT BE PLACED IN CURB RAMP OR LANDING.
- THE GUTTER LINE PROFILE OF THE STREET SHALL BE MAINTAINED THROUGH THE AREA OF THE CURB RAMP.
- THE FURNISHING ZONE BUFFERS PEDESTRIANS FROM THE ADJACENT ROADWAY, AND IS ALSO THE AREA WHERE ELEMENTS SUCH AS STREET TREES, SIGNAL POLES, UTILITY POLES, STREET LIGHTS, CONTROLLER BOXES, HYDRANTS, SIGNS, PARKING METERS, DRIVEWAY APRONS, GRATES, HATCH COVERS, AND STREET FURNITURE ARE PROPERLY LOCATED.

METROPOLITAN GOVERNMENT OF NASHVILLE AND DAVIDSON COUNTY DEPARTMENT OF PUBLIC WORKS	STANDARD CURB RAMP NOTES	DWG. NO. ST-215
ASST. DIR. ENG.: <i>Mark May</i>	DATE: <i>11/21/00</i>	REVISED: 11/10/00
DIRECTOR: <i>Paul J. O'Dell</i>	DATE: <i>11-20-00</i>	

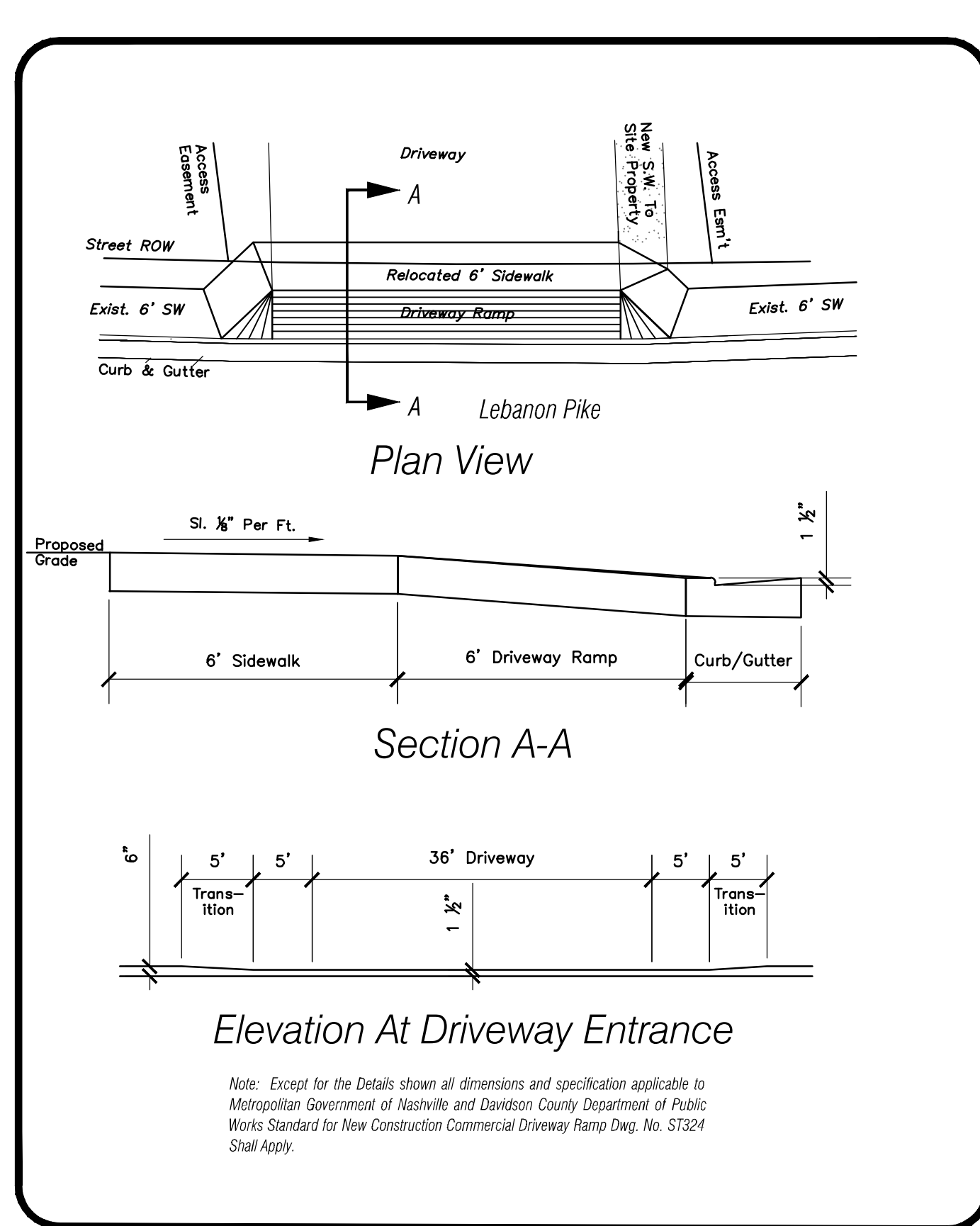

01 Detail Modifications to Metro Standard ST-324 Driveway Entrance Detail

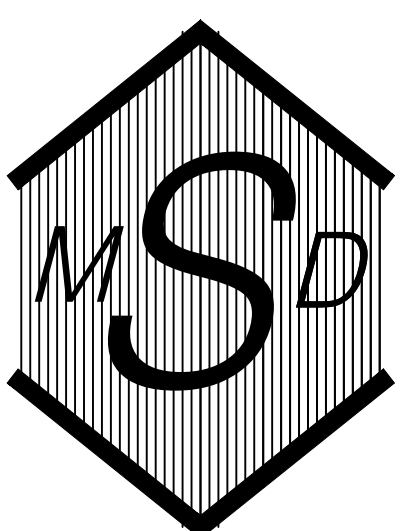

MURRAY D. SHANKLIN, P.E.
P.O. BOX 9
PORTLAND, TN 37148
615.512.2911
Email: mshanklin@ellsouth.net



Drawn	MDS
Checked By	MDS
Project No.	10 ROBERT BERARD
Date	07/15/2019

Revised 06/21/2016
Revised 07/03/2016
Revised 03/08/2019
Revised 07/31/2020

A New Multiply Family Home Complex
Apartment Concept
1636 Lebanon Pike
Nashville, Tennessee
Parcel No. 09400005000 and 09400004900

SHEET TITLE:
Metro Standard Details

SHEET NO.
C12.0

These plans and specifications and all rights reserved, are the sole and exclusive property of MURRAY D. SHANKLIN, P.E. Any reproduction, publication, exhibition, or use of all or any part thereof without the express written consent of MURRAY D. SHANKLIN, P.E. is strictly prohibited. Anyone viewing these plans is deemed to agree to the above and that MURRAY D. SHANKLIN, P.E. shall be entitled to recover reasonable damages and attorney's fees in any action to enforce the above provisions.

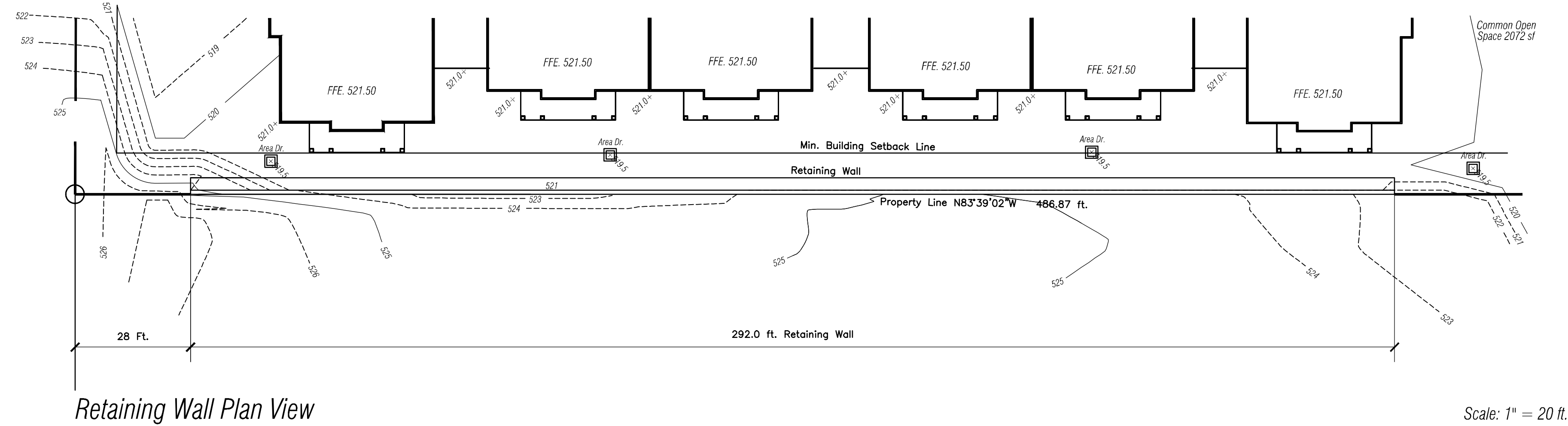

Retaining Wall Plan View

Scale: 1" = 20 ft.

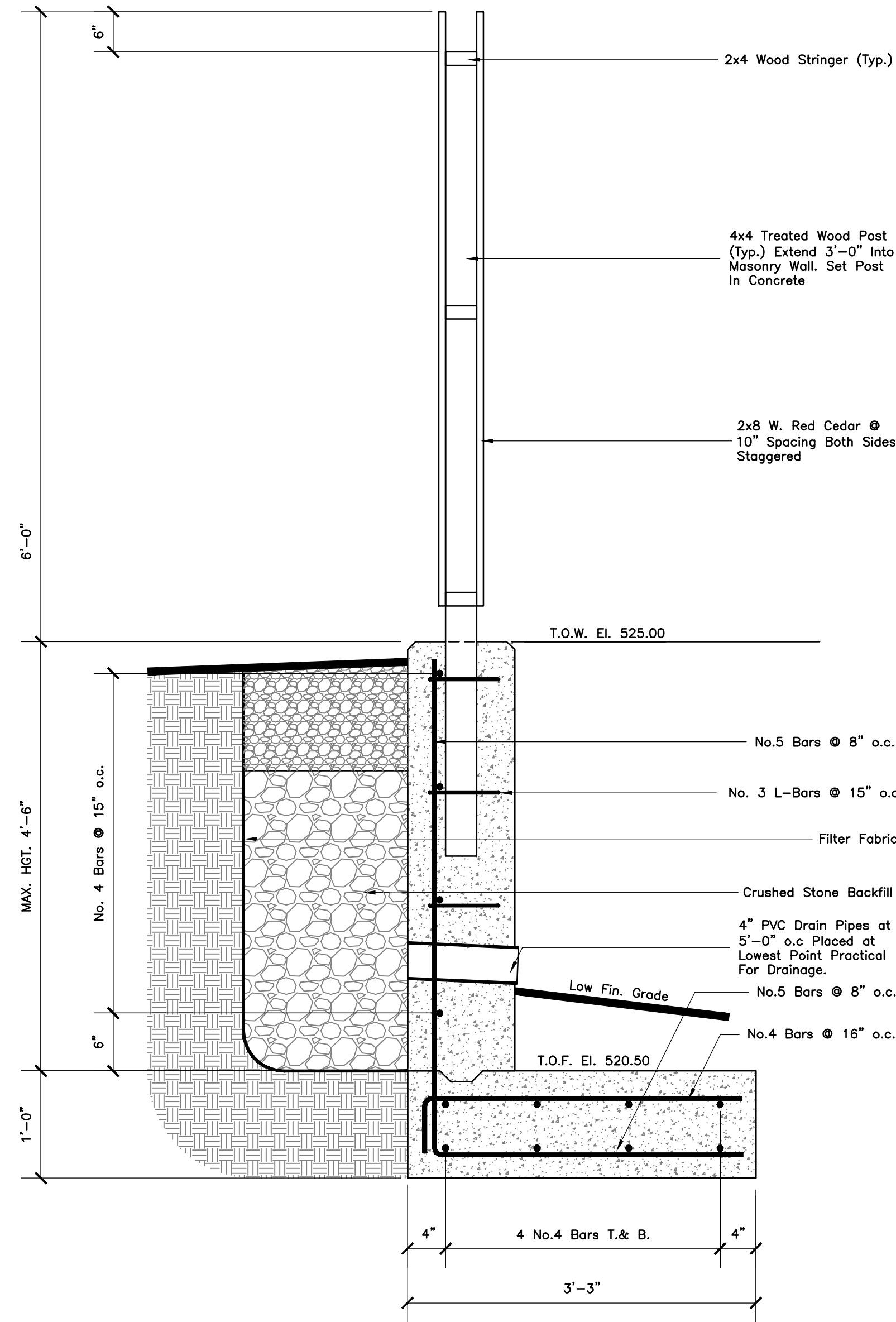

Section Showing Retaining Wall and Privacy Fence

N.T.S.

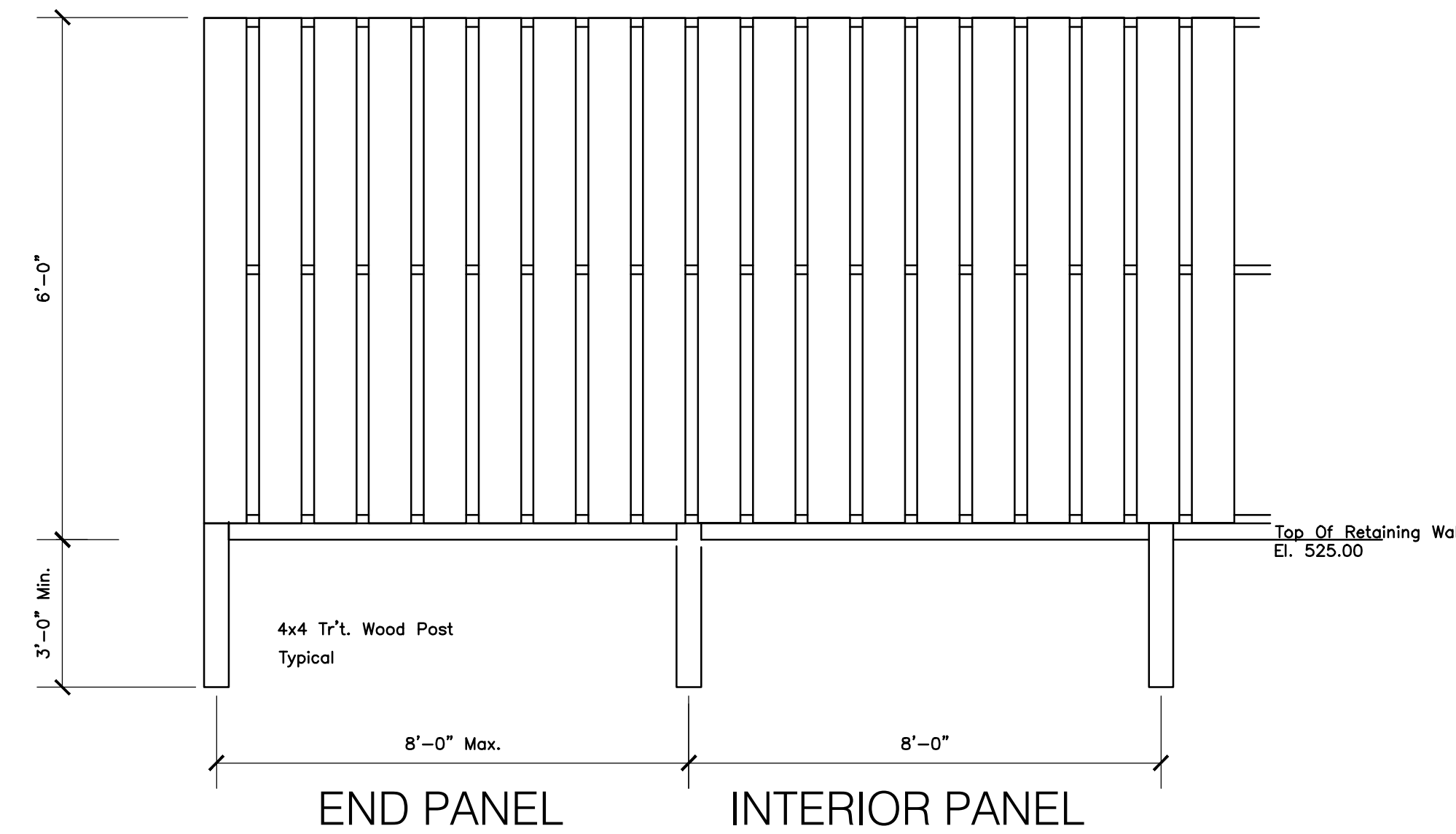

INSTALL IN ACCORDANCE WITH MANUFACTURER'S WRITTEN INSTRUCTIONS.

Elevation Showing Privacy Fence

N.T.S.

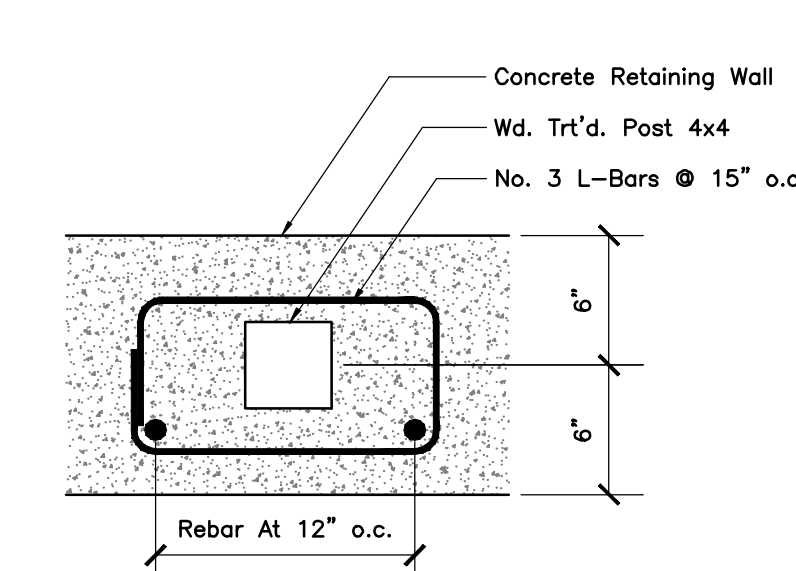

01 Detail

N.T.S.

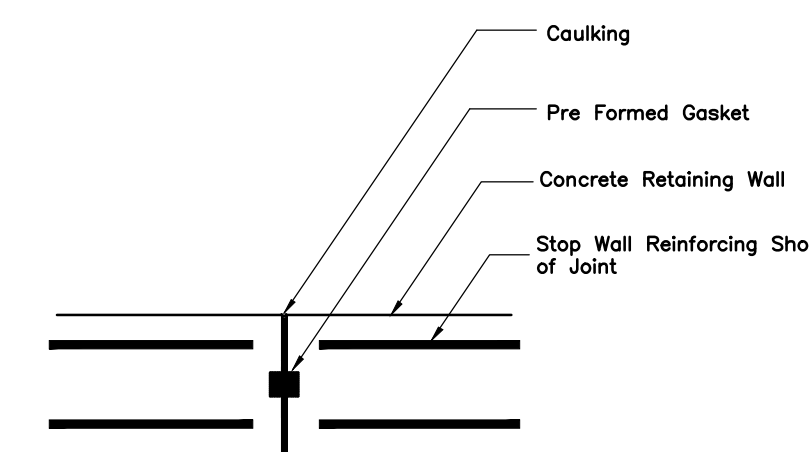

Note:
Locate Control Joints At 40 Ft. Spacing Max.

Typical Control/Exp. Joint

N.T.S.

FOUNDATION AND CONCRETE NOTES

1. F'c (COMPRESSIVE STRENGTH AT 28 DAYS TO BE 3500 PSI REINFORCING BARS 60 KSI F'Y (YIELD POINT) FOR ALL REINFORCING STEEL SHALL NOT BE LESS THAN 40000 PSI.
2. CONCRETE - A.C.I. STANDARD BUILDING CODE (A.C.I. 301 AND A.C.I. CODE OF STANDARD PRACTICE.
3. MASONRY: CONCRETE MASONRY UNITS SHALL CONFORM TO ASTM C90. FACE BRICK SHALL CONFORM TO ASTM C 73. MORTAR SHALL BE TYPE "M". GROUT SOLID JOINT BETWEEN BRICK AND CMU.
5. MORTAR AND GROUT PROPORTIONING: COMPRESSION STRENGTH AT 28 DAYS SHALL BE 1800 PSI FOR MORTAR AND 2000 PSI FOR GROUT. ALL PARTS SHALL BE BY LOOSE VOLUME MEASUREMENT.
-MORTAR: 1 PART PORTLAND CEMENT, 3.8 TO 3.75 PARTS SAND, AND 1/4 PART HYDRATED LIME. INCLUDE SPECIFIED MORTAR ADMIX IN MORTAR FOR EXTERIOR WALLS, PROPORTIONED PER ADMIX MANUFACTURER'S PRINTED DIRECTIONS.
-GROUT: 1 PART PORTLAND CEMENT, 3 PARTS SAND, AND 2 PARTS PEA GRAVEL (NO MORE THAN 1/10 PART LIME MAY BE ADDED). INCLUDE SPECIFIED GROUT ADMIX IN CONFORMANCE WITH MANUFACTURER'S PRINTED DIRECTIONS.
4. FOUNDATION ELEMENTS - SHALL BEAR ON SOIL HAVING BEARING CAPACITY OF NO LESS THAN 2000 PSF.
6. ALL REINFORCING BARS SHALL BE TIED AND SUPPORTED IN SUCH A MANNER AS TO PREVENT DISPLACEMENT DURING CONCRETE PLACING OPERATIONS. REINFORCEMENT VENDORS TO FURNISH ALL ACCESSORIES, CHAIRS, SPACER BARS AND SUPPORTS NECESSARY TO SECURE STEEL IN ACCORDANCE TO A.C.I. CODE OF STANDARD PRACTICE AND AS SHOWN ON PLANS.
7. CONCRETE COVERAGE FOR REINFORCEMENT, UNLESS OTHERWISE SHOWN SHALL BE AS FOLLOWS:
FOOTINGS - 3 INCHES
8. DURING THE CONSTRUCTION PERIOD, IT IS THE CONTRACTORS RESPONSIBILITY TO CHECK ALL DIMENSIONS AND SECTION SHOWN ON THE DRAWINGS AND REPORT TO THE ENGINEER OF ANY DISCREPANCIES FOUND.
9. THESE STRUCTURAL DRAWINGS AND DETAILS REPRESENT THE DESIRED RESULT OF CONSTRUCTION. THE METHODS OF CONSTRUCTION AND THE RISKS INVOLVED DURING CONSTRUCTION ARE THE SOLE RESPONSIBILITY OF THE CONTRACTOR.
10. DESIGN SOIL BEARING PRESSURE:
ISOLATED FOOTINGS - 2000 PSF
CONTINUOUS FOOTINGS - 2000 PSF
11. SHOULD SOFT OR OTHERWISE UNSUITABLE MATERIAL BE ENCOUNTERED IN THE BOTTOM OF AN EXCAVATION, SUCH MATERIAL SHALL BE REMOVED AND BACKFILLED WITH COMPACTED SUITABLE MATERIAL. COMPACTION SHALL BE SUCH AS TO ACHIEVE THE DENSITY OF THE MATERIAL IN NOTE NO. 10 ABOVE.
12. ANY LOOSE MATERIAL IN THE BOTTOM OF FOOTING TRENCHES CAUSED BY EXCAVATION OF THE TRENCH SHALL BE REMOVED OR COMPACTED TO A DENSITY EQUIVALENT TO THE UNDISTURBED AREAS PRIOR TO PLACING CONCRETE.
13. LIMIT EXCAVATION TO THE MINIMUM SIZE NECESSARY FOR FOUNDATIONS.
14. EXCAVATED FOOTING TRENCHES SHALL NOT BE LEFT OPEN TO ALLOW THE ACCUMULATION OF WATER. FOOTINGS SHALL BE CONCRETED IMMEDIATELY AFTER EXCAVATION IS COMPLETED, OR IF THIS CANNOT BE DONE, 4 TO 6 INCHES OF FOUNDATION MATERIAL SHOULD NOT BE REMOVED UNTIL PREPARATIONS FOR PLACING CONCRETE ARE COMPLETE. IN NO CASE SHALL CONCRETE BE PLACED ON FOOTING TRENCHES WHICH CONTAIN WATER.
15. ANCHOR BOLTS SHALL BE ASTM 307 OR EQUIVALENT.
16. PROVIDE CONSTRUCTION JOINTS AT 25' MAXIMUM ON CENTERS.

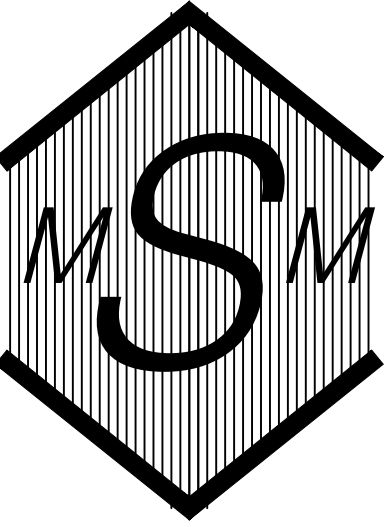

MURRAY D. SHANKLIN, P.E.
P.O. BOX 9
PORTLAND, TN 37148
615.512.2911
Email:
mdshanklin@bellsouth.net



Drawn MDS
Checked By MDS
Project No. 16 ROBERT BERARD
Date 09/20/2020

A New Multiply Family Home Complex
Apartment Concept
1636 Lebanon Pike

SHEET TITLE:

Retaining
Wall
Details

SHEET NO.

C13.0

PAUL W. BROOME
BK. 8687, PG. 595
(T.M. 94-12, PAR 30)
LOT 35
CLOVER NOOK
P.B. 2900, PG. 51
Zoning RS10

James C. Stemp, Sr.
I.N. 201105270040785
(T.M. 94-12, Par 31)
Lot 1
The Resubdivision Of Lot 34
Clovernook Subd.
P.B. 5200, Pg. 709
Zoning RS10

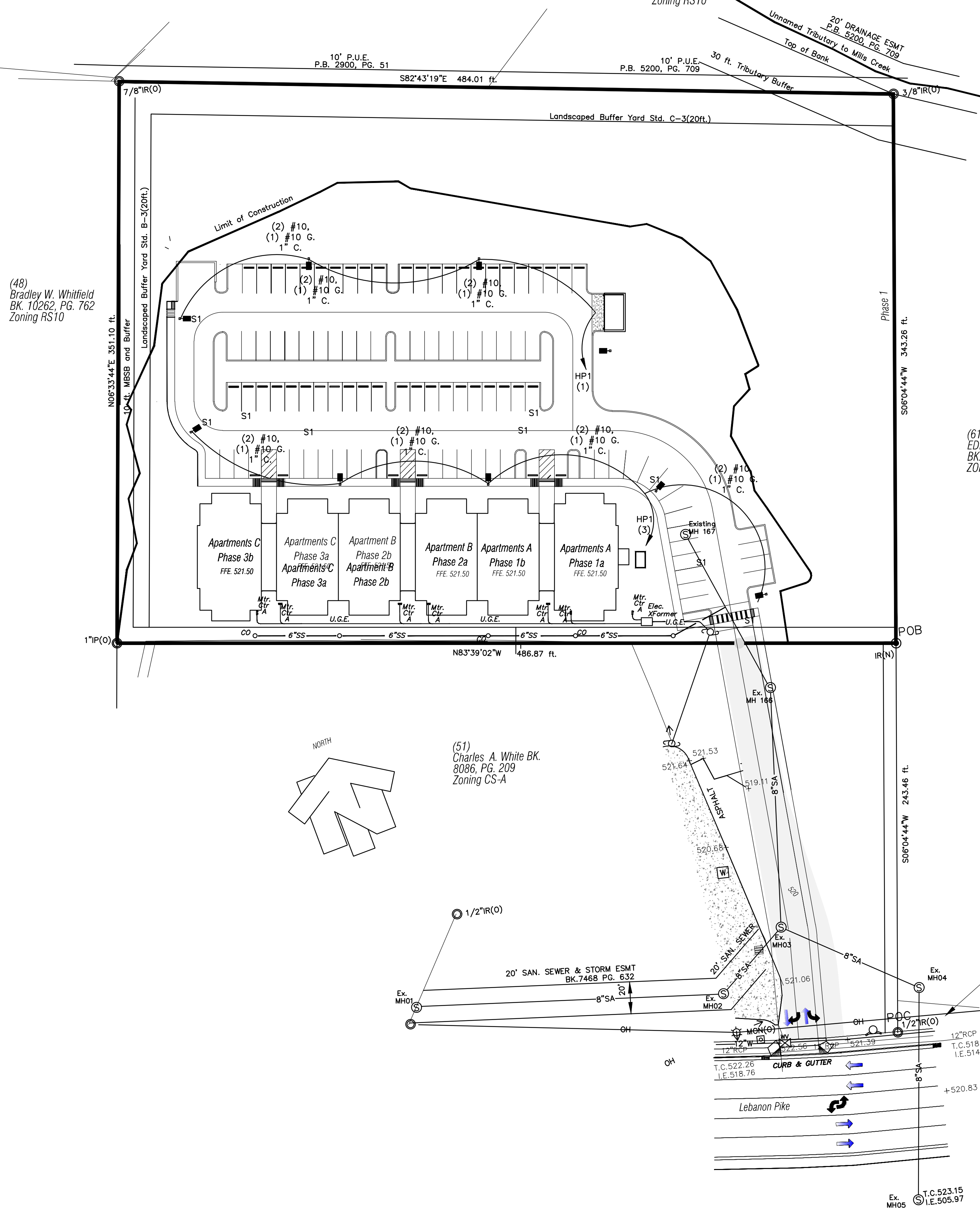

(48) Bradley W. Whitfield
BK. 10262, PG. 762
Zoning RS10

(61) EDITH DAVIDSON
BK. 2341, PG. 267
ZONING RS10

(51) Charles A. White BK.
8086, PG. 209
Zoning CS-A

(151) JAN B. TODD, TRUSTEE
I.N. 201204170032756

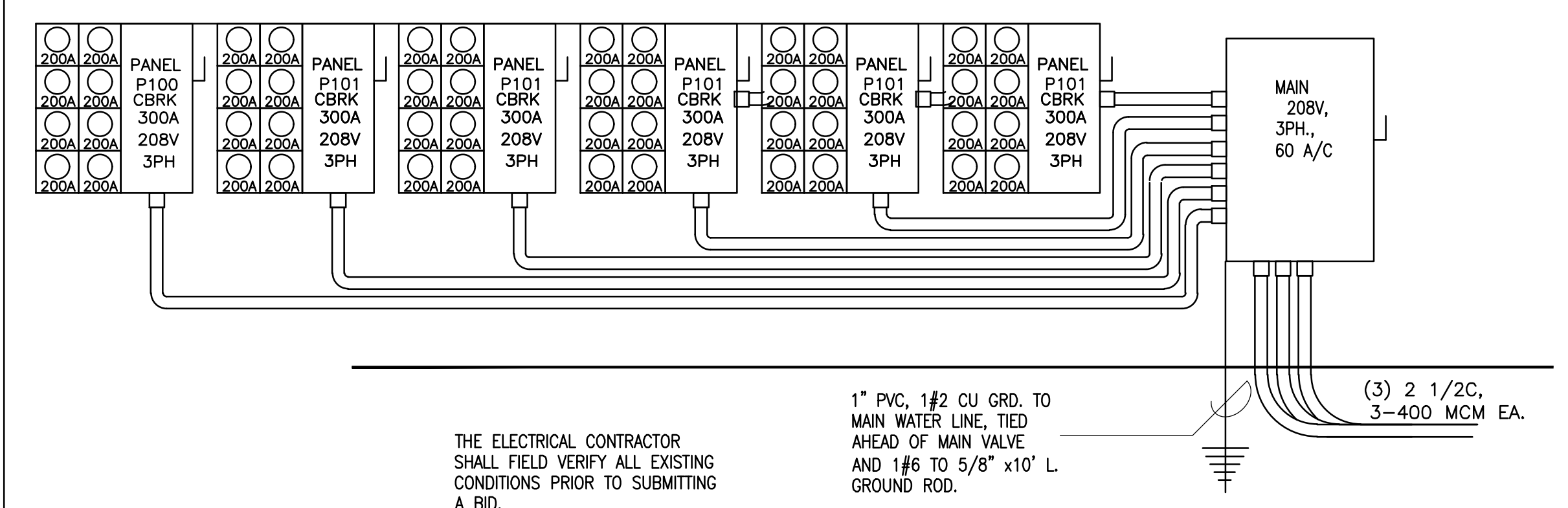

ELECTRICAL RISER DIAGRAM

ESTIMATED CONNECTED LOAD SUMMARY

PANELS "P1" THRU "P36" (SUM OF ALL)	
GENERAL ILLUMINATION:	96.5 KW
MISCELLANEOUS:	74.4 KW
AIR CONDITIONING:	610.4 KW
TOTAL LOADS:	781.2 KW

ESTIMATED CONNECTED LOAD SUMMARY

PANEL "HP" (HOUSE PANEL)	
GENERAL ILLUMINATION:	24.0 KW
MISCELLANEOUS:	
AIR CONDITIONING:	
TOTAL LOADS:	24.0 KW

ELECTRICAL NOTES

- Coordinate With The Local Power Company For Location Of Transformer Coordinate Location With Power Company Prior To Rough-in. Locations Shown Here For Representation Purposes Only.

03 TYPICAL ELECTRICAL ENTRANCE

LIGHTING FIXTURE SCHEDULE

TYPE	QTY	POLE HEIGHT	FIXTURE CATALOG NUMBER	NO./POLE	WATTS/ASS'BLY	LUMENS/LAMP	FULL CUTOFF	NOTES
S1	1	20 FT.	COOPER LIGHTING "Streetworks" USSL-PA18-740-U-T24-BZ	1	114	9886	YES	SEE POLE DTL. 04/A1.6

Numeric Summary

Label	CalcType	Units	Avg	Avg/Min	Max
CalcPts @ Grade	Illuminance	Fc	3.36	11.20	8.9
CalcPts @ Property Line	Illuminance	Fc	0.09	N.A.	0.09

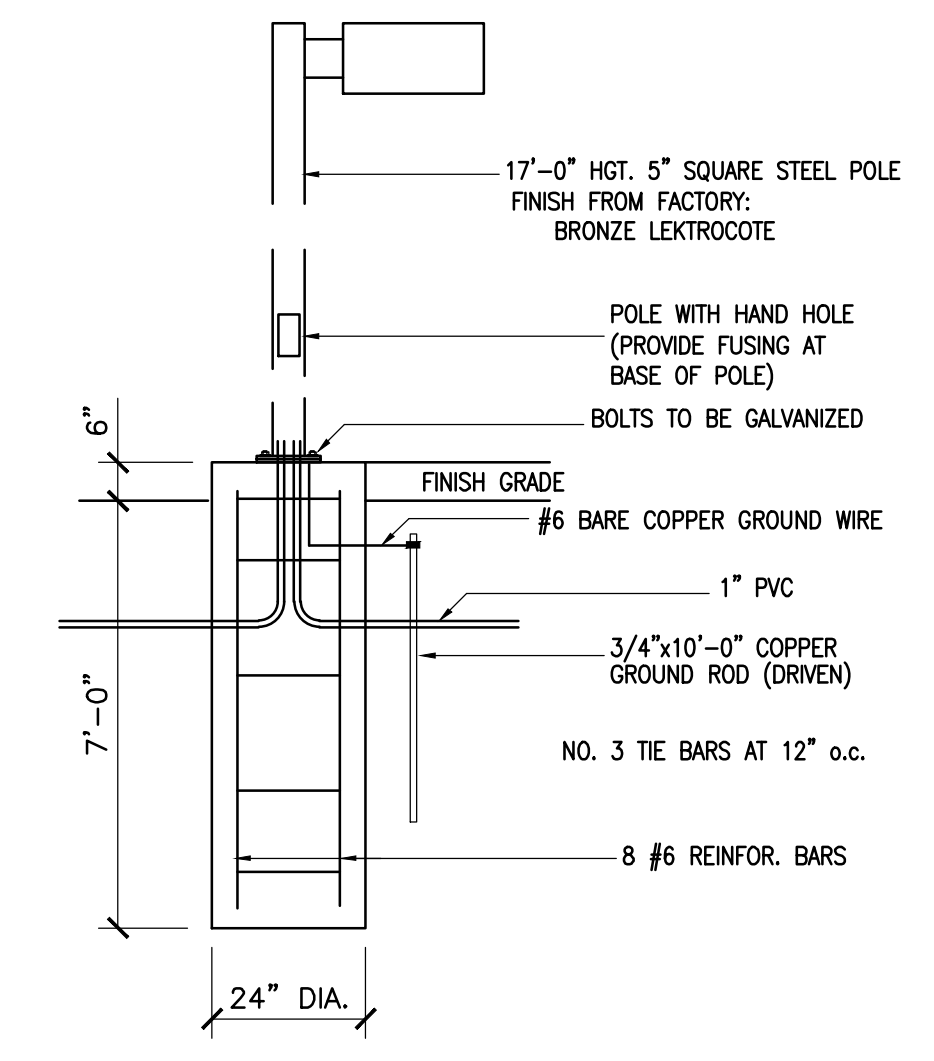

TYPICAL POLE MOUNTING DETAIL

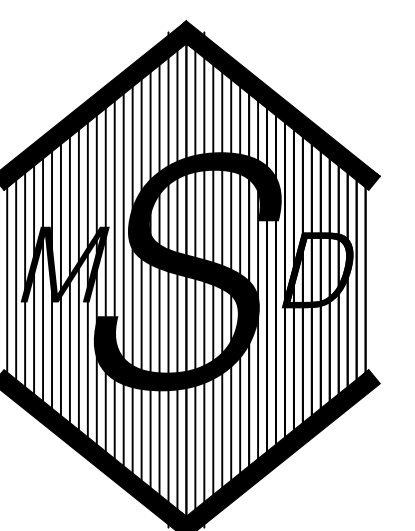

MURRAY D. SHANKLIN, PE
P.O. BOX 9
PORTLAND, TN 37148
615.512.2911
Email: mshanklin@elsouth.net



Drawn: MDS
Checked By: MDS
Project No.: 16 ROBERT BERARD
Date: 07/15/2019

Revised 06/21/2016
Revised 07/03/2016
Revised 07/15/2019

A New Multiply Family Home Complex
Apartment Concept
1636 Lebanon Pike
Nashville, Tennessee
Parcel No. 09400005000 and 09400004900

SHEET TITLE:
Site Lighting Layout

SHEET NO.:
ES1.0

These plans and specifications are of copies hereof, are the sole and exclusive property of MURRAY D. SHANKLIN, PE. Any reproduction, publication, exhibition, or use of all or any part thereof without the express written consent of MURRAY D. SHANKLIN, PE. is strictly prohibited. Anyone viewing these plans is deemed to agree to the above and that MURRAY D. SHANKLIN, PE. shall be entitled to recover reasonable damages and attorney's fees in any action to enforce the above provisions.

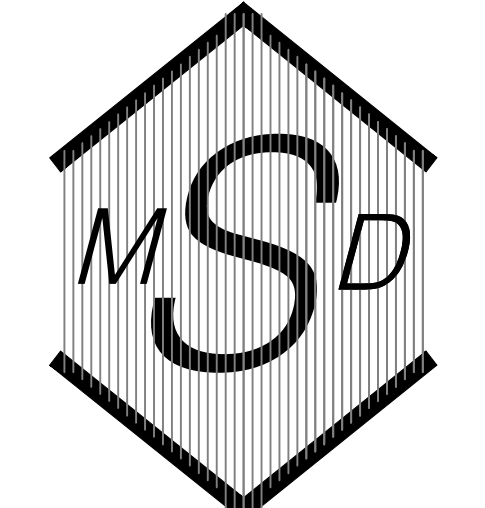

MURRAY D. SHANKLIN, PE
 P.O. BOX 9
 PORTLAND, TN 37148
 615.512.2911
 Email: mshanklin@bellsouth.net

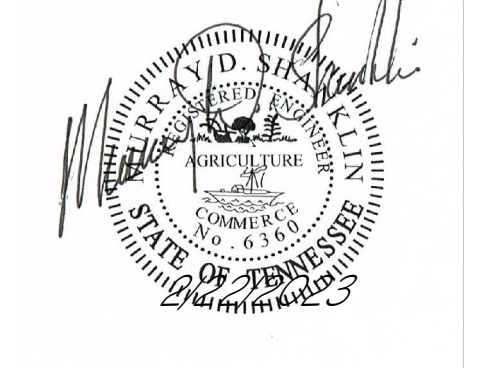

Drawn: MDS
 Checked By: MDS
 Project No.:
 Date: 06/27/2019



A New Multiply Family Home Complex
 Apartment Concept
 1636 Lebanon Pike
 Nashville, Tennessee
 Parcel No. 09400005000 and 09400004900

SHEET TITLE:
 Building Elevations

SHEET NO.
 A3.0



Front Elevation

Scale 3/32 Inch = 1 Foot

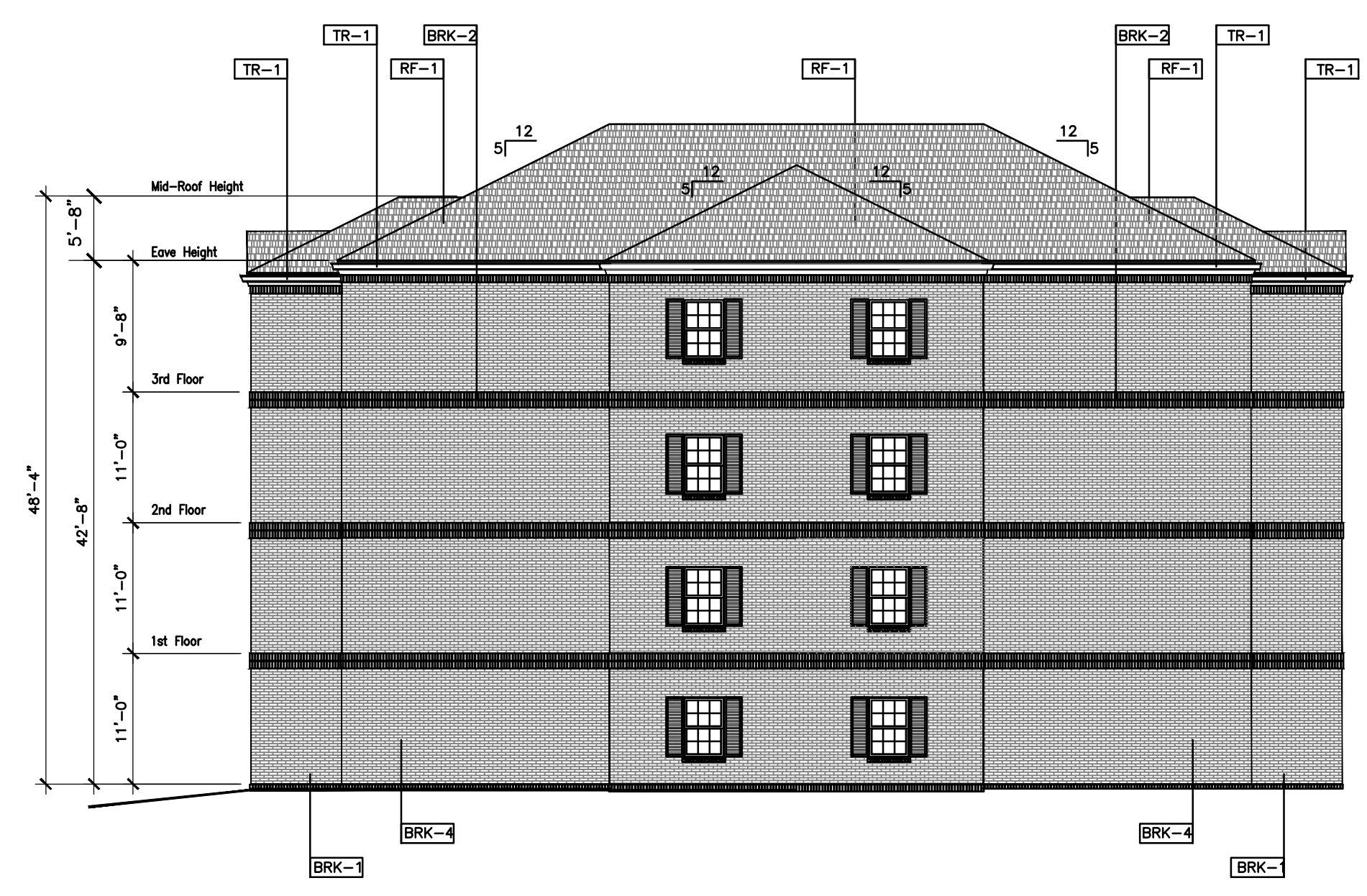

Left Side Elevation

Scale 3/32 Inch = 1 Foot

MARK	DISCRIPTION
BRK-1	FACE BRICK
BRK-2	BRICK, DOUBLE SOLDIER COARSE
BRK-3	BRICK, ORNAMENTAL WALL
BRK-4	BRICK, ORNAMENTAL COLUMN
BRK-2	BRICK, SOLDIER COARSE
FIN-1	COLUMN, 10x10 RECTANGLE
FIN-1	GABLE, EIFS
TR-1	GUTTERS FLASHINGm AND TRIM ALUMINUM PAINTED
FIN-1	LAP SIDING, REINFORCED CEMENTOUS BOARD PAINTED
RF-1	ROOFING, FIBERGLASS ASPHALT SHINGLE
RF-2	STANDING SEAM METAL ROOF PANELS, "WEATHERED COPPER"
LTC-1	40 W. LED WALL EXTERIOR LIGHTING COLOR "BRONZE".

Exterior Finishes

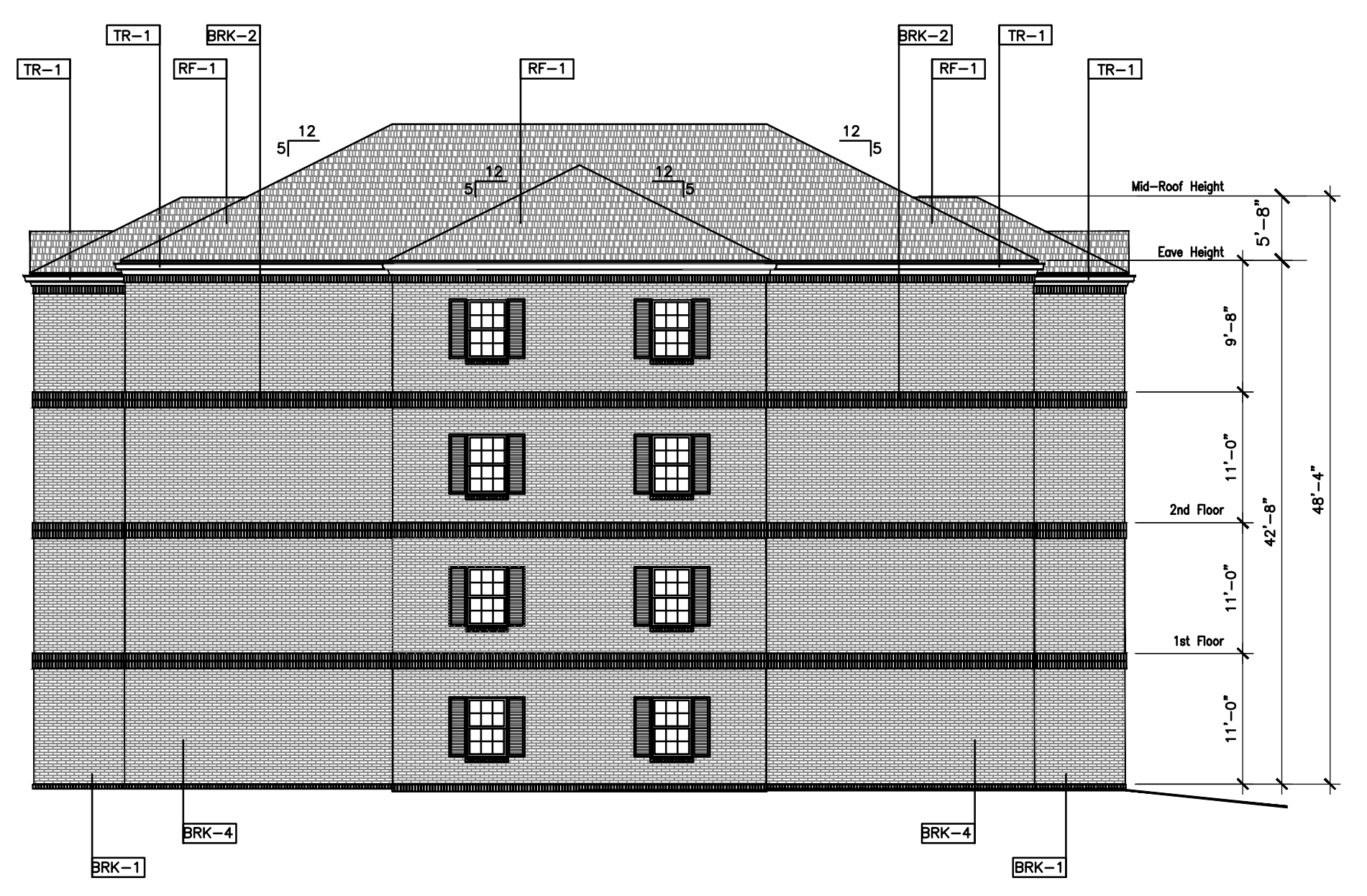

Scale 3/32 Inch = 1 Foot



Rear Elevation

Scale 3/32 Inch = 1 Foot

METRO PROJECT 2016SP-29-003

These plans and specifications and all copies hereof, are the sole and exclusive property of MURRAY D. SHANKLIN, P.E. Any reproduction, publication, exhibition, or use of all or any part thereof without the express written consent of MURRAY D. SHANKLIN, P.E. is strictly prohibited. Anyone viewing these plans is deemed to agree to the above and that MURRAY D. SHANKLIN, P.E. shall be entitled to recover reasonable design and attorney's fees in any action to enforce the above provisions.

PLANT LIST					
	QTY.	MARK	SPECIES	SIZE	REMARKS
INTERIOR TREES	19	AR	RED MAPLE Acer rubrum	2" CAL. 14'-16" HGT.	MATCHED
	1	BR	RIVER BIRCH Betula nigra	2" CAL. 14'-16" HGT.	
	7	CF	FLOWER DOGWOOD Cornus florida 'white cultivar'	2" CAL. 7' MIN. HGT.	MATCHED
	14	IF	FOSTER HOLLY Ilex x attenuata 'Foster'	2" CAL. 7' MIN. HGT.	MATCHED
	7	LS	SWEET GUM Liquidambar styraciflua	2" CAL. 12'-14" HGT.	
	11	MG	MAGNOLIA Magnolia grandiflora	2" CAL. 14'-16" HGT.	FULL TO BASE
	6	MV	SWEETBAY MAGNOLIA Magnolia virginiana	2" CAL. 9" MIN. HGT.	FULL TO BASE
	17	PF	SHORT LEAF PINE Pinus echinata	2" CAL. 7' MIN. HGT.	FULL TO BASE
	13	PY	YOSHINO CHERRY Prunus x yedoensis	2" CAL. 7' MIN. HGT.	WELL BRANCHED
	10	QN	NUTTALL OAK Quercus nuttallii (texana)	2 1/2" CAL. 14'-16" HGT.	WELL BRANCHED
SHRUBS	2	SN	BLACK WILLOW Salix nigra	2" CAL. 12'-14" HGT.	
	78	JV	JUNIPERUS VIRGINIANA/ Easter Red Cedar	2" CAL. 6" HGT.	FULL TO BASE
	45	JC	JAPANESE HOLLY Juniperus chinensis	24" HGT.	FULL TO BASE
	36	PL	OTTO LUYKEN LAUREL Prunus L. 'Otto Luyken'	24" HT.	3 GAL. FULL TO BASE
	153	PS	SCHIP LAUREL Prunus L. 'Schipkaensis'	30" HT.	3 GAL. FULL TO BASE
	34	PV	PRAGUE VIBURNUM Viburnum pragueans	30" HGT.	3 GAL. FULL TO BASE
PERENNIALS	80	HM	SWAMP MALLOW Hibiscus moscheutos	48" HGT.	3 GAL. SPACE AT 30" o.c.
	188	RH	BLACK-EYED SUSAN Rudbeckia hirta	36" HGT.	PLUGS - 1 GAL. SPACE AT 18" o.c.
SEDGES	560	CM	PALM SEDGE Carex muskingumensis	36" HGT.	1 GAL. SPACE AT 24" o.c.
SEEDING KY-31 FESCUE 8 LBS PER 1000 S.F. ALL DISTURBED AREAS NOT SOODED					

MULCH
FINE TEXTURE DARK IN COLOR HARDWOOD BARK
3" DEPTH ALL TREES, SHRUBS & BEDS

Landscape Design Requirements

- SITE COVERAGE RATIO:**
BUILDING/STRUCTURES 17,314 SF
PAVEMENT 37,614 SF
SIDEWALKS 4,502 SF
PADS 1,002 SF
TOTAL IMPERMEABLE 60,432 SF
TOTAL SITE 168,520 SF
TOTAL PERMEABLE 108,088 SF
PERCENT PERMEABLE 64.1%
RATIO TO TOTAL FLOOR AREA 41.1%
COMMON OPEN SPACE AREA: 6,404 SF
- STREET TREES:**
DISTANCE PROPERTY ABUTS STREET = 0.0 FT.
0 STREET TREES
- TREE PARKING REQUIREMENTS:**
No. Parking Spaces 105/15 = 7 Trees
- INTERIOR LANDSCAPE AREA:**
TOTAL PARKING AREA 37,614x0.08 = 3,009 SF MIN.
- TREE UNITS REQUIRED:**
NET SITE AREA 168,520-17,314=151,206 SF
MINIMUM TREE DENSITY 151,206/43,560 = 3.47 TREES PER ACRE
22*3.47=76.36 TREES
- MINIMUM TREE DENSITY:**
2" UNDERSTORY 0.25x49 = 12.25
2" CANOPY 0.50x137 = 68.50
TOTAL PROVIDED 80.75

EXISTING REMAINING TREES THAT ARE HEALTHY AND ARE 4" IN CALIPER DBH OR GREATER MAY BE COUNTED AS A SUBSTITUTE PROPOSED CANOPY FOR UNDERSTORY TREES AS APPROVED BY METRO URBAN FORESTER.

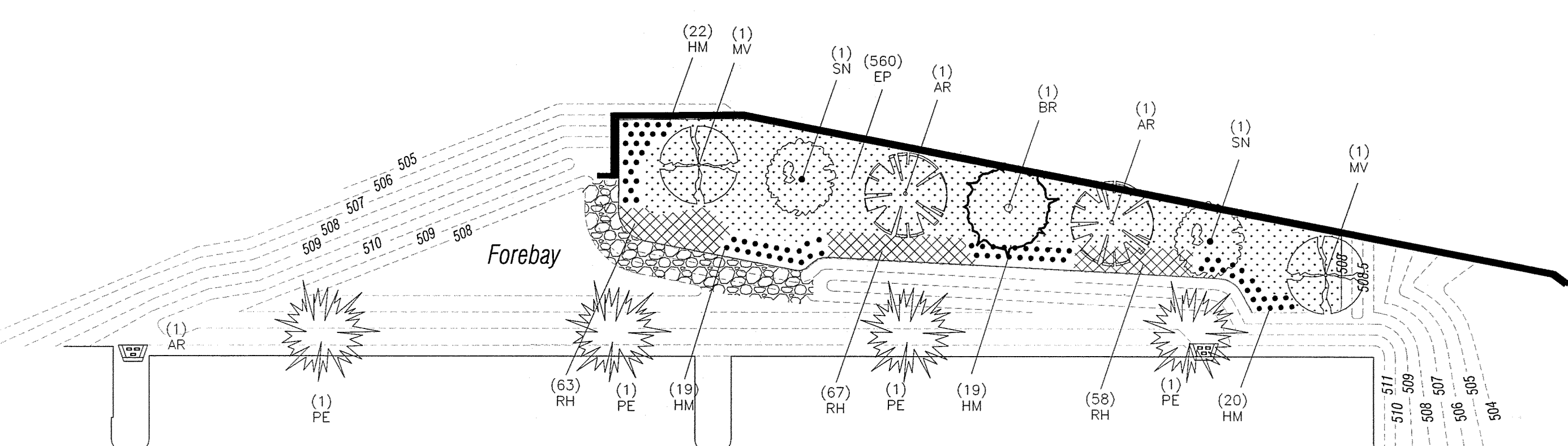
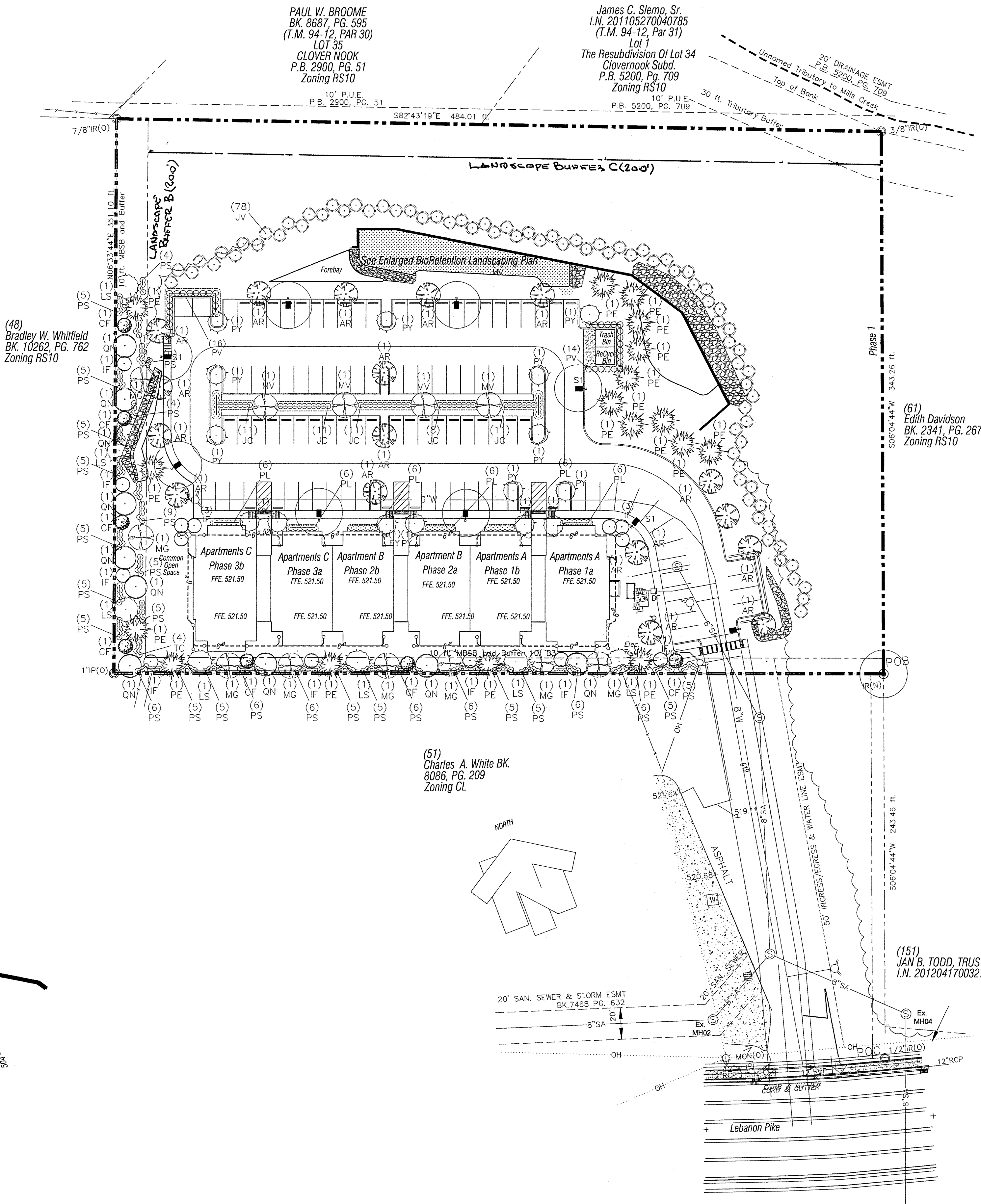

Enlarged Landscape Plan at Bioretention Area

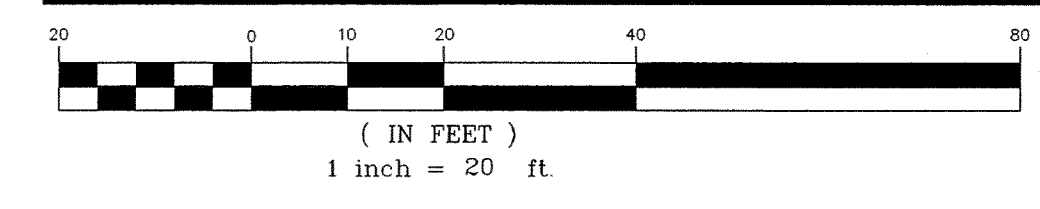

Landscape Plan

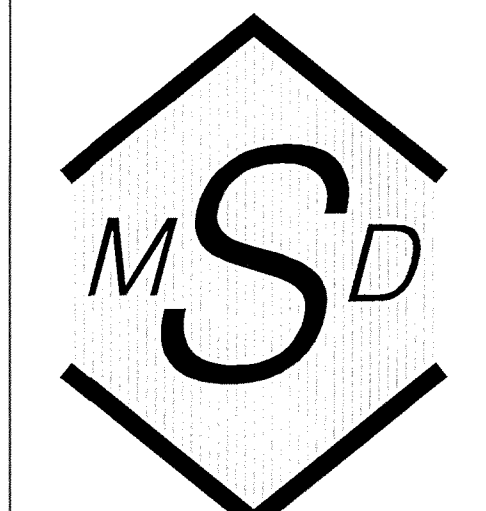
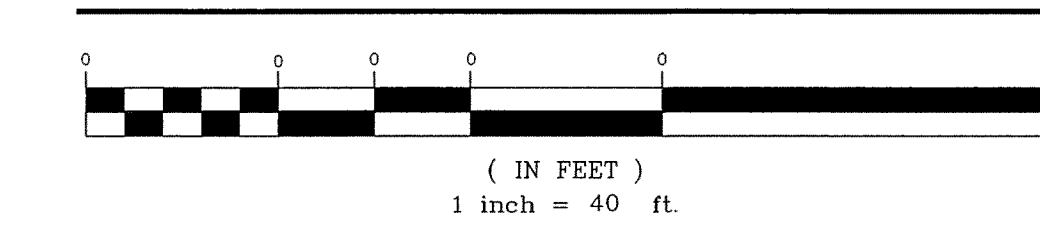

MURRAY D. SHANKLIN, P.E.
P.O. BOX 9
PORTLAND, TN 37148
615.512.2911
Email:
mshanklin@bellsouth.net

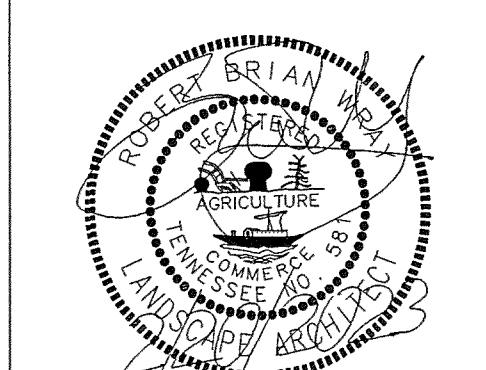

Drawn MDS
Checked By MDS
Project No. 16 ROBERT BERARD
Date 07/15/2019
Revised 07/15/2019

A New Multiply Family Home Complex
Apartment Concept
1636 Lebanon Pike
Nashville, Tennessee
Parcel No. 09400005000 and 09400004900

SHEET TITLE:
Landscape Plan

SHEET NO.
L1.0

Tree Selection Specification:

- There Shall Be No Circling Or Girdling Roots. Circling Roots Should Be Cut In At Least One Place.
- Trees Should Be Rooted Into The Root Ball So That Soil Or Media Remains Intact And Trunk And Root Ball Move As One When Lifted, But Not Root Bound. The Trunk Should Bend When Gently Pushed And Should Not Be Loose So It Pivots At Or Below Soil Line.
- The Point Where The Top-most Root In The Root Ball Emerges From The Trunk Shall Be Within Two Inches Of The Soil Surface. It Can Be Exposed And Visible At The Soil Surface. If It Is Not Within The Top Two Inches Of Soil, Gently Remove The Top Layer Of Soil From The Rootball Until The First Major Root Flare Is Visible.
- The Relationship Between Caliper, Height And Rootball Size Shall Meet Ansi Z60.1 Standard, Latest Edition.
- There Should Be One Dominant Leader To The Top Of The Tree With The Largest Branches Spaced At Least 6 Inches Apart. There Can Be Two Leaders In The Top 25% Of The Tree If It Is Otherwise Of Good Quality.
- The Tree Canopy Should Be Mostly Symmetrical And Free Of Large Voids. Clear Trunk Should Be No More Than 40% Of Tree Height Unless Otherwise Specified In The Planting Specifications.
- Open Trunk And Branch Wounds Shall Be Less Than 10% Of The Circumference At The Wound And No More Than 2 Inches Tall. Properly Made Pruning Cuts Are Not Considered Open Trunk Wounds. There Should Be No Conks Or Bleeding, And There Should Be No Signs Of Insects Or Disease On More Than 5% Of The Tree.
- If Any Of The Above Conditions Are Not Met, Trees May Be Rejected.

Tree Planting Specifications:

- The Depth Of The Hole Dug Should Be About 10% Less Than The Distance From The Top-most Root (measured Where It Joins The Trunk) To The Bottom Of The Root Ball. The Width Of The Hole Shall Be At Least 1.5 Times The Width Of The Rootball.
- Cut Away Burlap And Wiring So That At Least 1/3 Of The Rootball Is Exposed. Synthetic Burlap Shall Be Removed Entirely. All Twine And Rope Shall Be Removed From The Base Of The Tree And From Any Branches.
- After Planting, The Topmost Root Shall Be No More Than 2 Inches Below The Soil Surface. Additional Soil Should Be Removed. The Surrounding Grade Should Be Even With Or Slightly Lower Than The Top Root. Please Note: Some Trees Will Arrive From The Nursery With Too Much Soil Covering The First Major Root Flare. This Soil Should Be Removed. The Resulting Soil Line Should Be Even With Or Above The Surrounding Grade.
- 2-3 Inches Of Mulch Should Be Applied To Cover The Sides Of The Rootball To A Point Even With The Dripline. Do Not Add Any Soil To Of The Rootball. Do Not Add More Than 1 Inch Of Mulch To The Top Of The Rootball.
- In Poorly Drained Soil, Position The Top Of The Rootball 10% Or More Above The Surrounding Grade. No More Than 20% Of The Rootball Should Be Above The Surrounding Grade.
- If Trees Are Staked, Stakes Shall Not Come Into Contact With The Rootball. Guy Wires Shall Not Be Drawn Taught, But Should Supply Just Enough Tension To Prevent The Tree From Swaying A Great Deal. All Stakes, Wiring And Harnesses Shall Be Removed Within One Year Unless Otherwise Specified.

Tree Replacement Notes

- Total minimum tree density shall be 14 Tree Density Units (TDUs) per gross acre, less building coverage. Tree Density Units shall be calculated using Metro Ordinance system for calculating points for existing and proposed trees. Existing trees used for TDU credit shall be shown on the final Landscape Planting Plans with location, size (DBH), and species.
- Proposed trees used for calculating tree density shall have a minimum caliper of 2 inches and shall be a minimum of 6 feet tall.
- Trees counted for TDUs shall be protected by a chain link fence and shall be installed per detail on Detail 04 Drawing L1.1.
- Proposed tree and Shrub species shall be taken from the Metro Adopted Urban Forestry Recommended Tree and Shrub List unless otherwise approved.
- Proposed shrubs within Landscape Treatment areas shall be a minimum of 18" at the time of installation.
- Proposed trees within the Landscape Treatment area may be used for TDU credit.
- At completion, the installation of plant materials shall be inspected by the Designer of Record to verify compliance with the approved plan.
- An underground irrigation system or an approved alternate shall be installed for all proposed trees, shrubs, and ground cover.

Landscape Notes

- This Project Was Designed In Accordance With Metro Nashville Davidson Tennessee Design Ordinances And Policies. It Is Recommended That Prior To Bidding Or Beginning Planting That The Contractor Be Familiar With Requirements Of This Ordinance As It Pertains To Quality Of Workmanship Plant Selection, And Inspections.
- The Plant List Is For The Convenience Of The Contractor, However, The Contractor Shall Confirm All Quantities Prior To Bidding. If The Plant List And Plan Quantities Differ, The Plan Shall Take Precedents.
- Provide Trees, Shrubs And Plants Of Quantity, Size And Genus Species And Variety Shown And Scheduled For Landscape Work And Complying With Recommendations And Requirements Of ANSI Z60.1, Latest Edition, "American Standards For Nursery Stock". Provide Healthy, Vigorous Stock, Grown In A Recognized Nursery In Accordance With Good Horticultural Practices And Free Of Disease, Insects, Eggs, Larvae And Defects Such As Knots, Sun-Scald, Injuries, Abrasions Or Disfigurement.
- Locations Of All Plant Beds And Trees To Be Staked And Approved By Owner Prior To Planting.
- Determine Location Of Underground Utilities And Perform Work In A Manner Which Will Avoid Possible Damage. Hand Excavate, As Required. Maintain Grade Stakes Set By Others Until Removal Is Mutually Agreed Upon By Parties Concerned.
- If Topsoil Is Required, Provide New Topsoil Which Is Fertile, Friable Natural Loam, Surface Soil, Reasonable Free Of Subsoil, Clay Lumps, Brush, Weed, And Other Litter, And Free Of Roots, Stumps, Stones, Larger Than 2" In Any Dimension, And Other Extraneous Or Toxic Matter Harmful To Plant Growth.
- All Groundcover Beds Shall Be Treated With A Pre-emergent Herbicide "tralan" Or Equal Prior To Planting.
- All Trees, Shrubs And Beds Shall Be Mulched With A Uniform Layer Of Hardwood Bark Mulch. The Mulch Shall Be Fine Textured, Free Of Large Pieces Or Wood Or Bark And Dark In Color.
- Beds Shall Be Shovel Edged To Form A Neat Trench 3" In Depth.
- Mulch Beds Shall Be Slightly Mounded (6") Over Adjoining Surfaces.
- Contractor To Warranty All Plantings For A Period Of One Year After Date Of Final Acceptance By Owner. Warranty To Include All Defects Including Death Of Unsatisfactory Growth, But Not Neglect Of Proper Care By Owner.

Legend

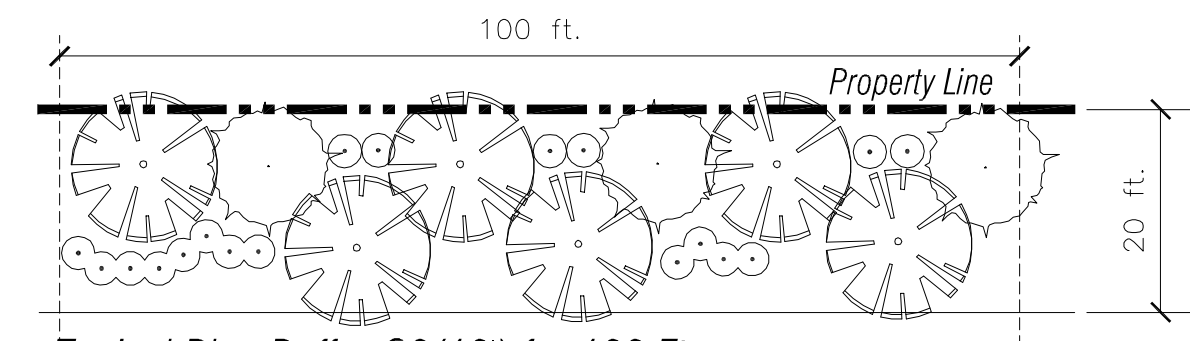

Typical Plan Buffer C3(10') for 100 Ft

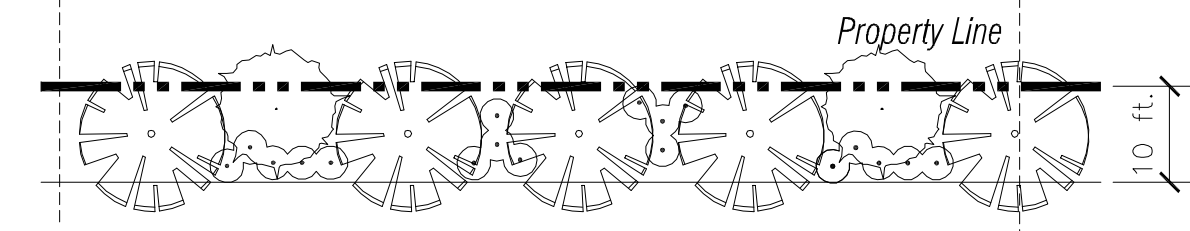

Typical Plan Buffer B3(10') for 100 Ft

Proposed Canopy Trees

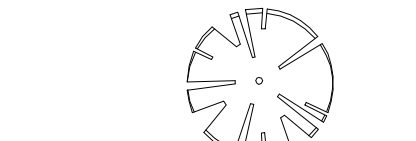

Proposed Understory Trees



Proposed Proposed Shrubs



Proposed Biodetention Shrubs and Grasses

Distance S Equal Spacing. See Enlarged Bioretention Planting Plan

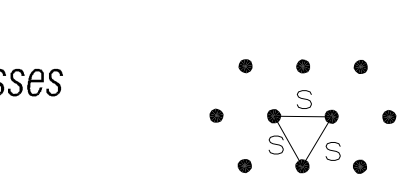

Tree Protection Fencing Notes

- Tree protection fence shall be minimum of 4' tall and constructed of orange safety fabric or chainlink. Fence shall be mounted on vertical pipes driven 2' in the ground, at a maximum of 8' on center for safety fence or 10' for chainlink.
- Tree protection fencing shall be erected at the dripline of the tree or 15' from the trunk, whichever is greater. Fence shall be installed prior to the start of any clearing, grading or other construction activity.
- No storage or construction activity of any kind may take place within the tree protection zone.

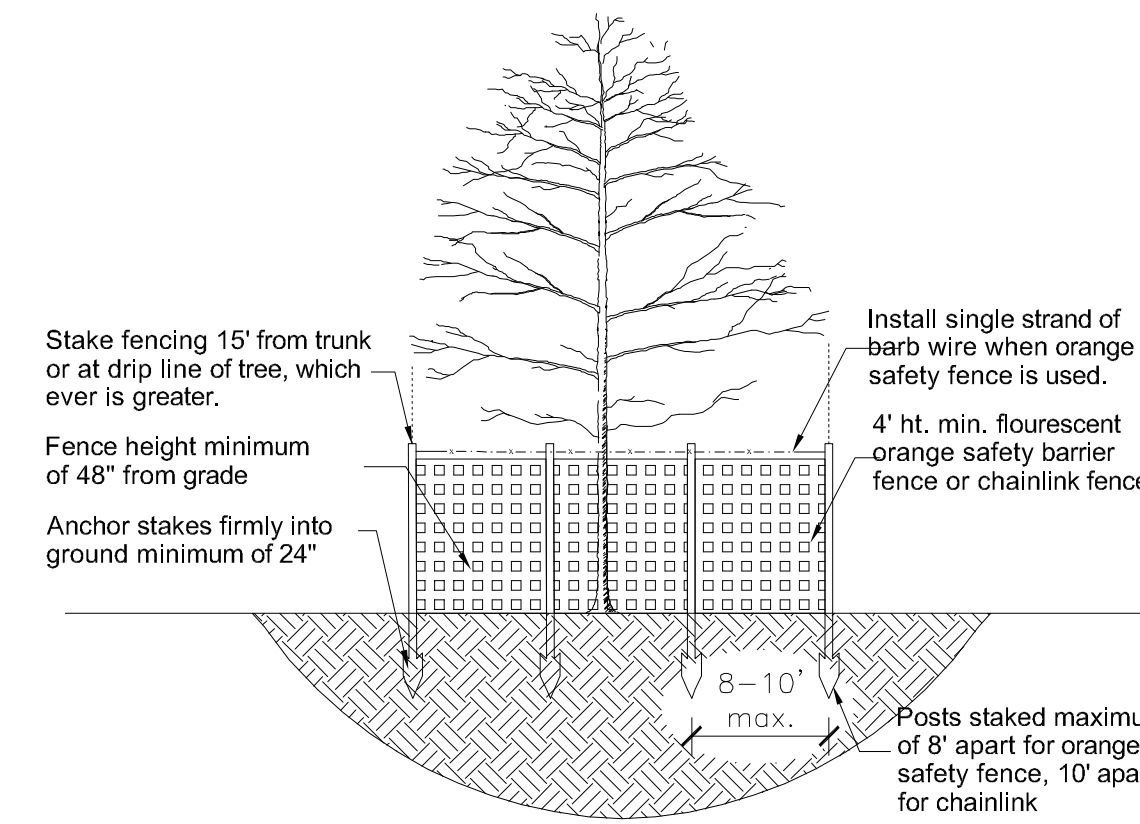
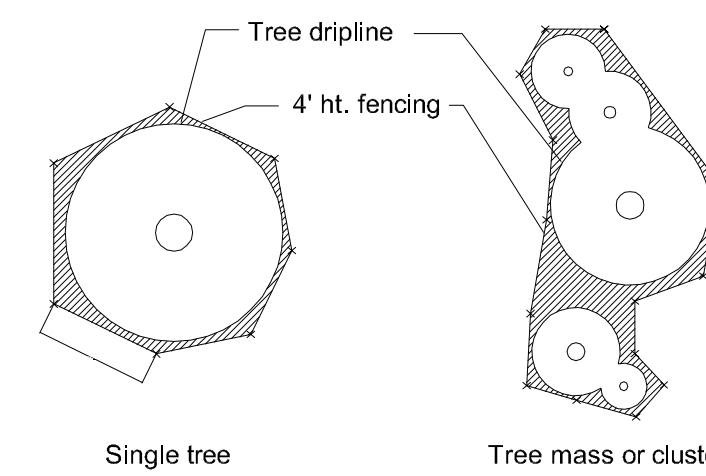

04 Tree Protection Detail

N.T.S.

01 Deciduous Tree Planting Detail

N.T.S.

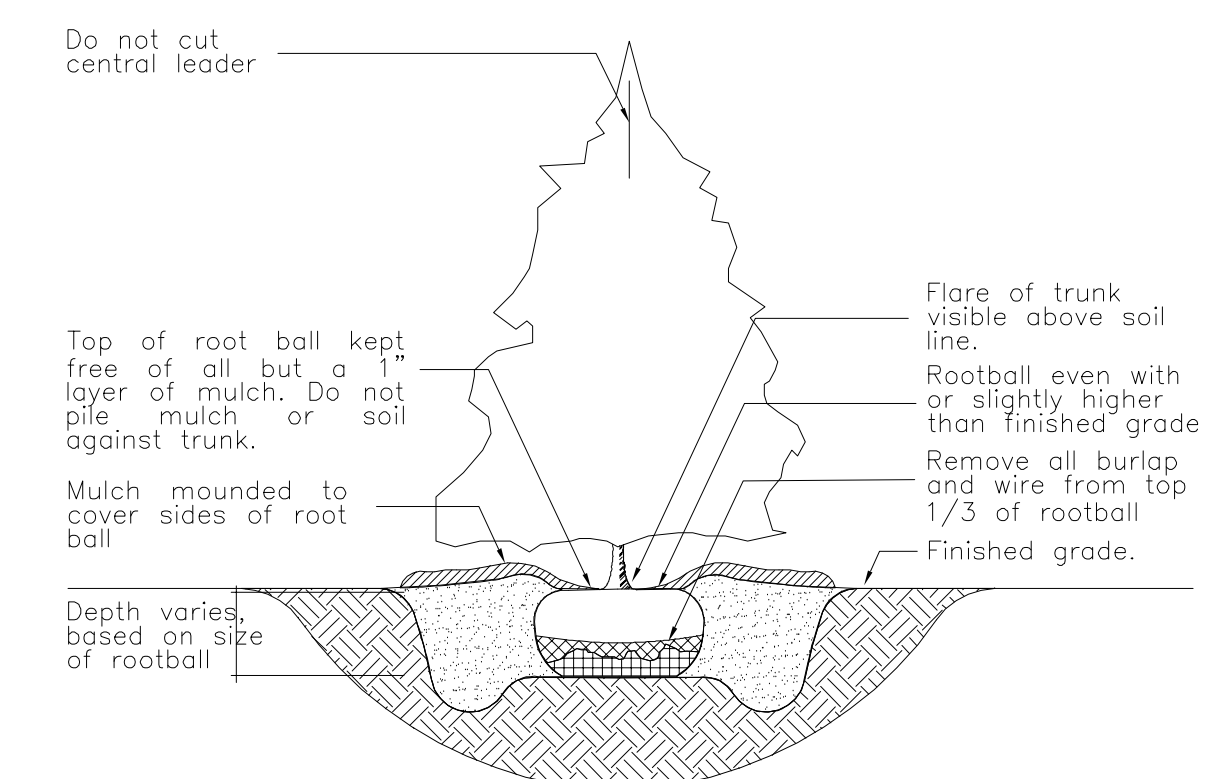

02 Evergreen Tree Planting Detail

N.T.S.

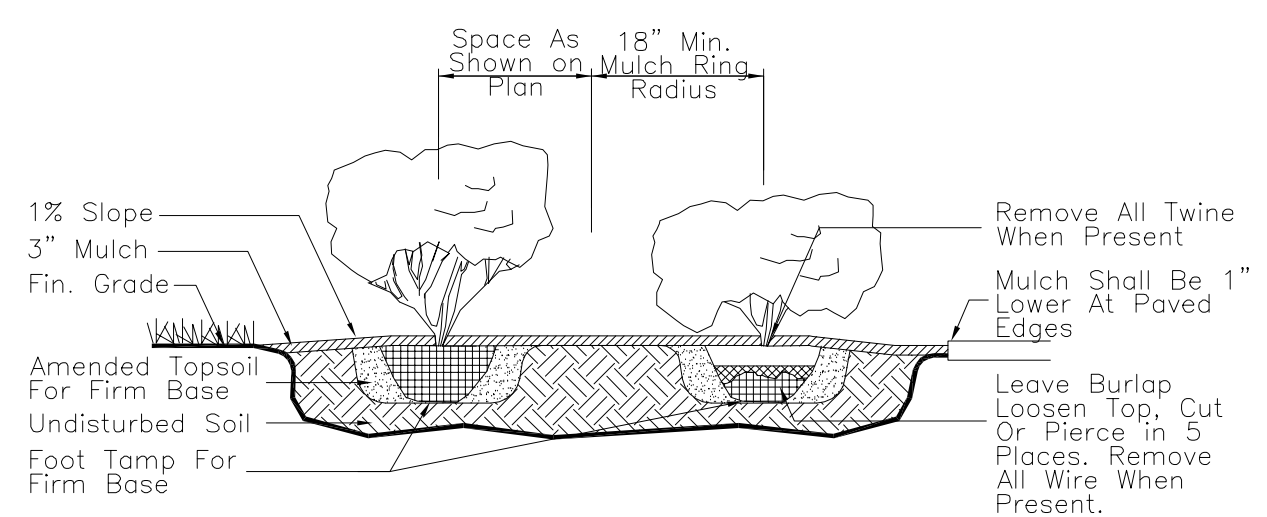

03 Shrub Planting Detail

N.T.S.

Where Roots Have Wounded Radially Inside Containers, Cut 1/2" Deep Into Ball In Three Places To Prevent Girdling.

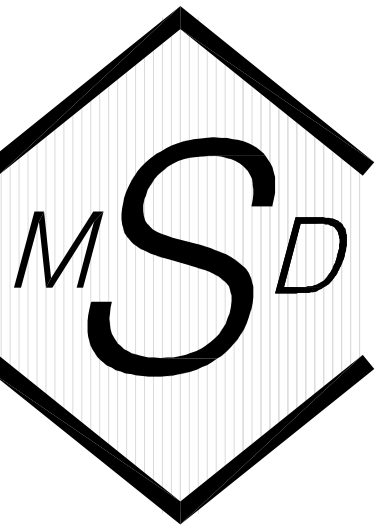

MURRAY D. SHANKLIN, PE

P.O. BOX 9
PORTLAND, TN 37148
615.512.2911
Email:
mdshanklin@ellsouth.net

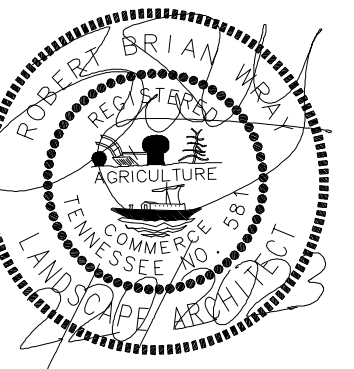

Drawn MDS

Checked By MDS

Project No. 16 ROBERT BERARD

Date 07/15/2019

A New Multiply Family Home Complex
Apartment Concept
1636 Lebanon Pike
Nashville, Tennessee
Parcel No. 09400006000 and 09400004900

SHEET TITLE:

Landscape
Details

SHEET NO.

L1.1

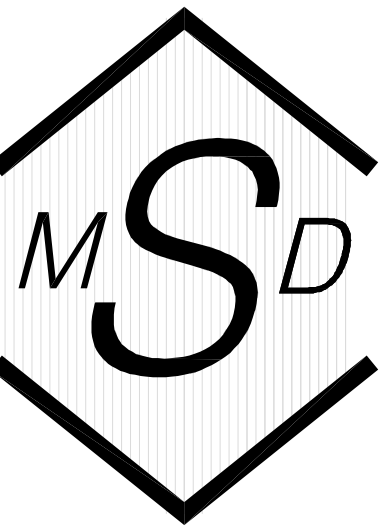

MURRAY D. SHANKLIN, PE

P.O. BOX 9
PORTLAND, TN 37148
615.512.2911
Email:
mdshanklin@bellsouth.net

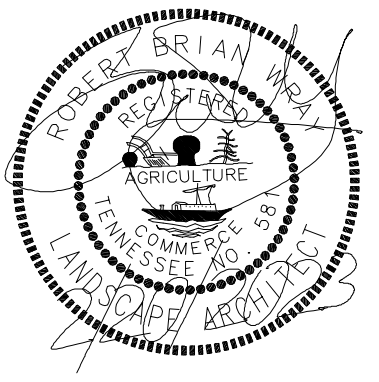

Drawn MDS

Checked By MDS

Project No. 16 ROBERT BERARD

Date Revised 07/15/2019

Revised 07/15/2019

A New Multiply Family Home Complex
Apartment Concept
1636 Lebanon Pike
Nashville, Tennessee
Parcel No. 09400005000 and 09400004900

SHEET TITLE:

Landscape Irrigation Intent Plan

SHEET NO.

L1.2

