

AMENDED PRELIMINARY SP

1908 LEBANON PIKE RESIDENTIAL

NASHVILLE, DAVIDSON COUNTY, TENNESSEE

2021SP-037-003
 CATALYST PROJECT NO. 20210002
 APRIL 28, 2021; JUNE 2, 2021; JUNE 11, 2021, DECEMBER 08, 2022, JANUARY 03, 2023

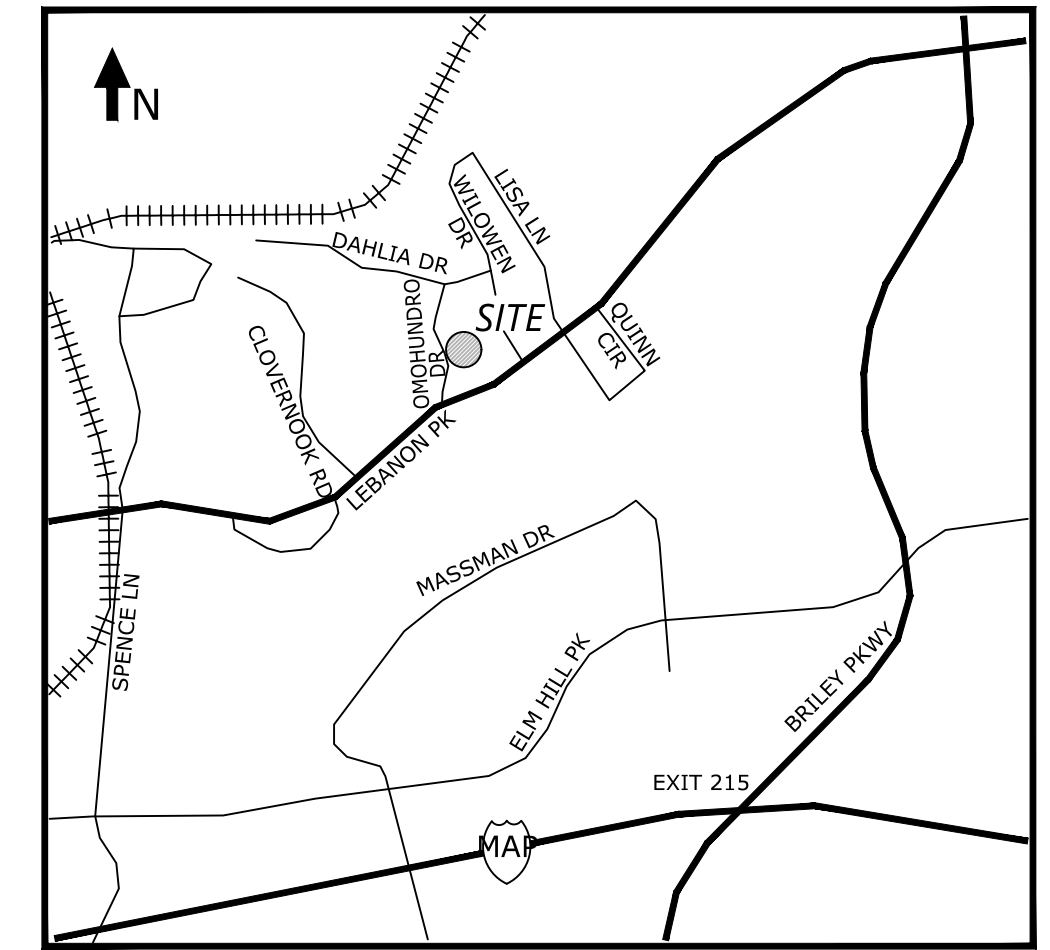

VICINITY MAP
 NOT TO SCALE

DEVELOPMENT SUMMARY

- SP NAME: 1908 LEBANON PIKE RESIDENTIAL
- SP NUMBER: 2021SP-037-001
- COUNCIL DISTRICT: 15
- COUNCIL MEMBER: JEFF SYRACUSE

OWNER: RICHARD GILES AND NICK ORY PRIDE
 ADDRESS: 616 AYERS STREET
 SPRING HILL, TN 37174

PROJECT REPRESENTATIVE: CATALYST DESIGN GROUP
 ADDRESS: 5100 TENNESSEE AVENUE
 NASHVILLE, TN 37209
 PHONE NO.: 615.622.7200
 CONTACT NAME: JEFFREY D. HEINZE
 CONTACT E-MAIL ADDRESS: jheinze@catalyst-dg.com

DEVELOPER: RED SEAL DEVELOPMENT
 ADDRESS: 5202 CENTENNIAL BLVD., #107
 NASHVILLE, TN 37209
 PHONE NO.: 847.417.5610
 CONTACT NAME: TODD FISHBEIN
 CONTACT E-MAIL ADDRESS: tfishbein@redsealhomes.com

- FEMA PANEL:
 THE SUBJECT PROPERTY DOES NOT LIE WITHIN THE 100 YEAR FLOOD PLAIN AND IS DETERMINED TO BE IN ZONE "X" ACCORDING TO COMMUNITY PANEL NO. 47037C0262H, APRIL 5, 2017, COMMUNITY NAME: FEMA COMMUNITY NAME.

DEVELOPMENT SITE DATA

PARCEL ID.: 09509001100 & 09509001200
 SITE ADDRESS: 1908 LEBANON PIKE
 NASHVILLE, TN 37210

SITE ACREAGE:
 PARCEL 11: 1.05 Ac. (45,717 SQ. FT.)
 PARCEL 12: 4.58 Ac. (199,697 SQ. FT.)
 TOTAL SITE ACREAGE: 5.63 Ac. (245,414 SQ. FT.)
 R.O.W. DEDICATION:
 OMOHUNDRO DRIVE: 0.10 Ac. (4,169 SQ. FT.)
 ROAD 'A': 0.48 Ac. (20,894 SQ. FT.)
 TOTAL ADJUSTED SITE ACREAGE: 5.05 Ac. (220,351 SQ. FT.)
 EXISTING ZONING: RS10 (RESID. SINGLE FAMILY 10,000 S.F. LOTS)
 ZONING OVERLAY: OV-AIR
 FALLBACK ZONING: RM20-A (MULTI-FAMILY RESIDENTIAL)
 EXISTING LAND USE: VACANT RESIDENTIAL LAND
 PROPOSED LAND USE: 9 SINGLE-FAMILY RESIDENTIAL LOTS AND 40 MULTI-FAMILY RESIDENTIAL UNITS
 PROPOSED DENSITY: 8.7 UNITS / ACRE

BUILDING DATA
 PROPOSED LAND USE: 9 SINGLE-FAMILY RESIDENTIAL LOTS AND 40 MULTI-FAMILY RESIDENTIAL UNITS

BUILDING SQUARE FOOTAGE:
 TOWNHOME RESIDENCES: 100,000 SQ. FT. (MAXIMUM)
 SINGLE-FAMILY RESIDENCES: 35,000 SQ. FT. (MAXIMUM)

FAR: 0.55
 BUILDING HEIGHT: 45' MAX.
 (MEASURED PER METRO ZONING CODE)

PARKING REQUIREMENTS:
 METRO CODE REQUIRED:
 SINGLE-FAMILY LOTS (2 SP./LOT=9x2): 18 SPACES
 3 BR. TOWNHOMES (2.5 SP./BR.=40x2.5): 100 SPACES
 TOTAL PARKING REQUIRED: 118 SPACES

PARKING PROVIDED:
 GARAGE PARKING: 98 SPACES
 SURFACE PARKING: 9 SPACES
 TANDEM COMPACT PARKING (BLDG. A, B & F): 11 SPACES
 TOTAL PARKING PROVIDED: 118 SPACES
 TOTAL PARKING RATIO: 2.41 SPACES / UNIT

DEVELOPMENT NOTES

1. THE PURPOSE OF THIS PLAN IS FOR PRELIMINARY APPROVAL OF SPECIFIC PLAN ZONING TO PERMIT 49 RESIDENTIAL UNITS.
2. ALL DEVELOPMENT WITHIN THE BOUNDARIES OF THIS PLAN MEETS THE REQUIREMENTS OF THE AMERICANS WITH DISABILITIES ACT AND THE FAIR HOUSING ACT.
 ADA: <http://www.ada.gov/>
 U.S. Justice Dept.: http://www.justice.gov/crt/housing/fairhousing/about_fairhousingact.htm
3. TRASH AND RECYCLING SERVICE SHALL BE CONTRACTED THROUGH A PRIVATE COLLECTION SERVICE.

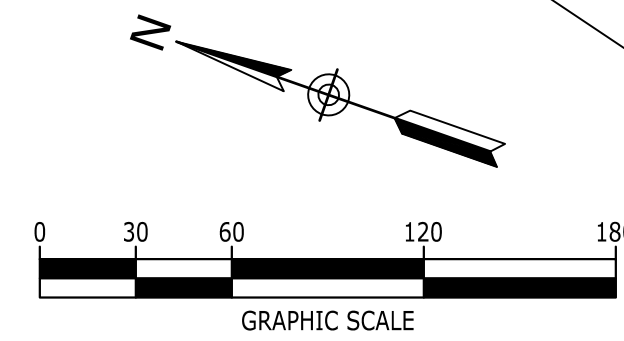
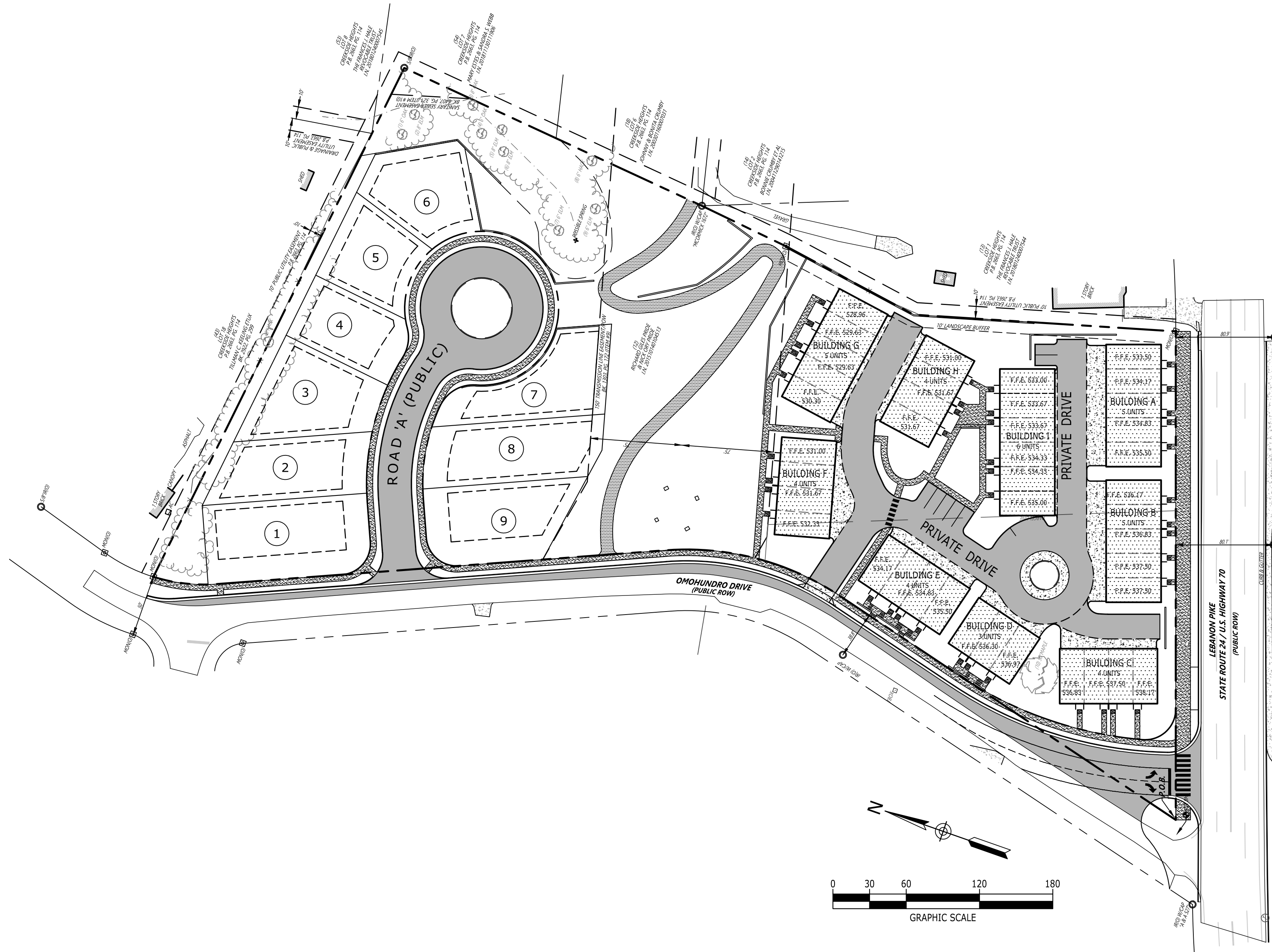

Sheet List Table	
Sheet Number	Sheet Title
C0.0	COVER
C1.0	EXISTING CONDITIONS
C5.0	RENDERED SITE PLAN
C5.1	SITE LAYOUT
C5.2	FIRE ACCESS PLAN
C6.0	SITE GRADING & DRAINAGE
C7.0	SITE UTILITIES
L1.0	SITE LANDSCAPE
A4.1	SP ELEVATIONS

METRO STANDARD NOTES

1. THE FINAL SITE PLAN/BUILDING PERMIT SITE PLAN SHALL DEPICT THE REQUIRED PUBLIC SIDEWALKS, ANY REQUIRED GRASS STRIP OR FRONTAGE ZONE AND THE LOCATION OF ALL EXISTING AND PROPOSED VERTICAL OBSTRUCTIONS WITHIN THE REQUIRED SIDEWALK AND GRASS STRIP OR FRONTAGE ZONE. PRIOR TO THE ISSUANCE OF USE AND OCCUPANCY PERMITS, EXISTING VERTICAL OBSTRUCTIONS SHALL BE RELOCATED OUTSIDE OF THE REQUIRED SIDEWALK. VERTICAL OBSTRUCTIONS ARE ONLY PERMITTED WITHIN THE REQUIRED GRASS STRIP OR FRONTAGE ZONE.
2. ALL CONSTRUCTION WITHIN THE R.O.W. IS TO BE PER ADA AND MPW STANDARDS AND SPECIFICATIONS.
3. THERE SHALL BE NO VERTICAL OBSTRUCTIONS (POLES, SIGNS, GUY WIRES, ETC.) WITHIN THE SIDEWALKS.

DESIGN STANDARDS

1. BUILDING FACADES FRONTING A STREET SHALL PROVIDE A MINIMUM OF ONE PRINCIPAL ENTRANCE (DOORWAY) FACING TOWARD ONE PRIMARY STREET (WHERE DOUBLE FRONTAGES OCCUR) AND MINIMUM GLAZING CRITERIA, AS FOLLOWS: MULTIFAMILY - 20% MIN. GLAZING WITH THE SIDE ELEVATION OF BLDG. C (FACING LEBANON PIKE) MEETING A 15% GLAZING THRESHOLD. SINGLE FAMILY RESIDENCES - 15% MIN. GLAZING WITH THE SIDE ELEV. OF LOTS 1 AND 9 (FACING OMOHUNDRO DR.) MEETING A 12% GLAZING THRESHOLD.
2. WINDOWS SHALL BE VERTICALLY ORIENTED AT A RATIO OF 1.5:1 OR GREATER, EXCEPT FOR DORMERS.
3. EIFS, VINYL SIDING, AND UNTREATED WOOD SHALL BE PROHIBITED.
4. PORCHES SHALL PROVIDE A MINIMUM OF FIVE FEET OF DEPTH.
5. A RAISED FOUNDATION OF 18"-36" IS REQUIRED FOR ALL RESIDENTIAL STRUCTURES.

ARCHITECT
CENTRIC ARCHITECTURE, INC.
 35 PEABODY STREET
 NASHVILLE, TN 37210
 615.385.9600

PREPARED FOR
RED SEAL DEVELOPMENT
 5202 CENTENNIAL BLVD., #107
 NASHVILLE, TN 37209
 847.417.5610

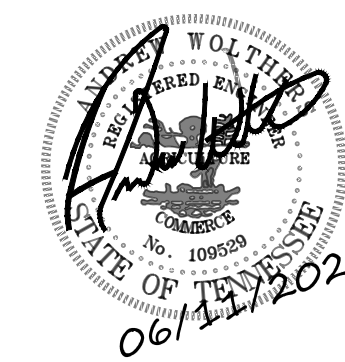

CIVIL ENGINEER/LANDSCAPE ARCHITECT
Catalyst
 DESIGN GROUP
 5100 TENNESSEE AVENUE
 NASHVILLE, TN 37209
 (615) 622-7200



COVER

C0.0

LEGEND

PARCEL NO.	(xx)
IRON ROD (OLD)	IR(O)
IRON ROD (SET)	IR(N)
CONCRETE MON (OLD)	MON(O)
PROPERTY LINE	---
FENCE LINE	x
CONTOUR LINE	-500
OVERHEAD POWER LINE	OH
SANITARY SEWER LINE	8" SAN
STORM SEWER LINE	15" ST
WATER LINE	8" W
GAS LINE	2" G
TELEPHONE MANHOLE	TM
UTILITY POLE	UP
GUY WIRE	GW
UTILITY POLE W/ LIGHT	UPL
SANITARY SEWER MANHOLE	SSM
CURB INLET	CI
CATCH BASIN	CB
FIRE HYDRANT	FH
WATER METER	WM
WATER VALVE	WV
GAS VALVE	GV
SIGN POST	SP
CONCRETE	CON

CURVE	ARC LENGTH	RADIUS	DELTA ANGLE	TANGENT	CHORD BEARING	CHORD LENGTH
C1	150.08'	226.25'	38°00'20"	77.92'	N04°36'36"W	147.34'
C2	52.54'	139.42'	21°55'53"	26.59'	N12°49'00"W	52.23'

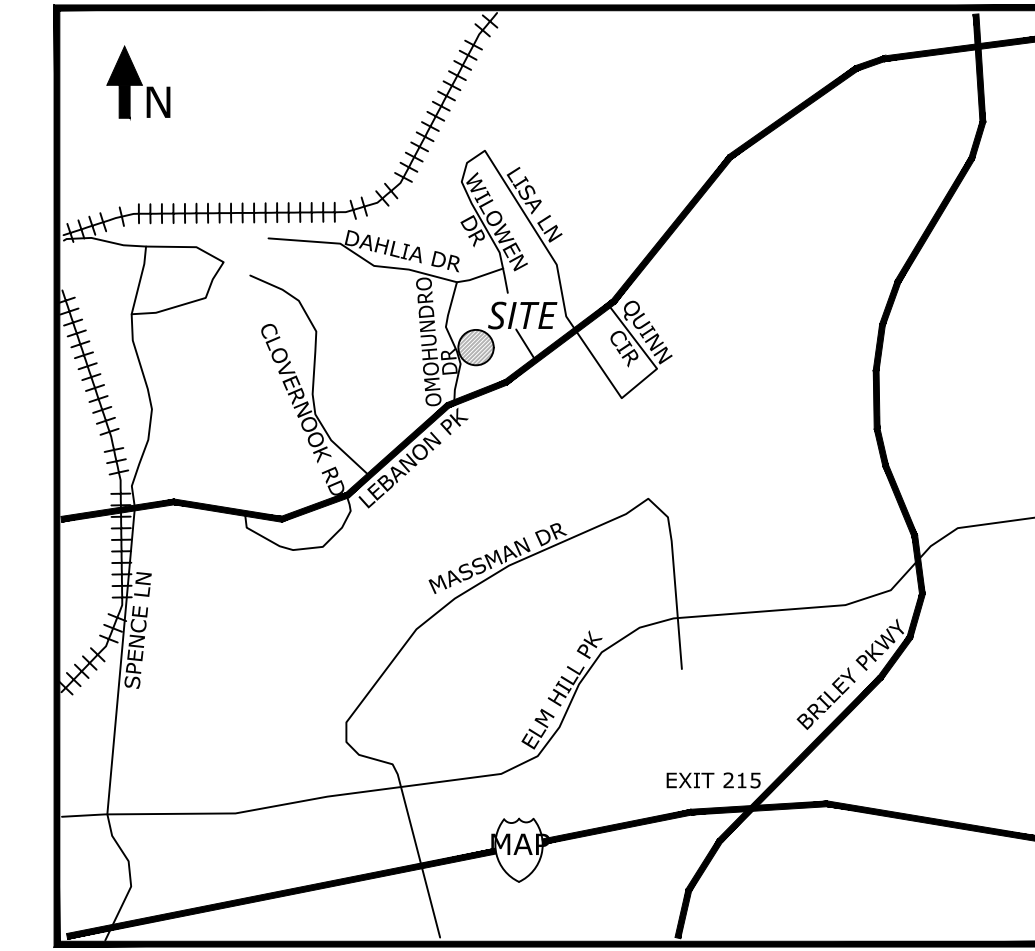

VICINITY MAP
NOT TO SCALE



- ◆ SITE BM: TAG BOLT #9511V3 ON FIRE HYDRANT LOCATED NEAR THE NORTHEAST ROW INTERSECTION OF LEBANON PIKE AND OMOHUNDRO DRIVE. ELEV: 538.23
- ◆ PROJECT BM: NAVD 88 (GPS DERIVED)

Number	Minimum Slope	Maximum Slope	Area	Color
1	15.00%	20.00%	55068.48	[Light Gray Box]
2	25.00%	100.00%	38759.30	[Dark Gray Box]

Symbol	Name and Description	Rating	Acres
SvD	Stiversville-Urban land complex, 3 to 25% slopes	A	5.6

NOTE: SOIL INFORMATION ON THIS SHEET WAS OBTAINED FROM NRCS ONLINE SOIL SURVEY DATA. AREAS ARE APPROXIMATE AND ARE FOR REFERENCE ONLY.

BASE INFORMATION WAS TAKEN FROM A SURVEY PREPARED BY S & ME, DATED 3/3/21. CATALYST DESIGN GROUP AND ANY OF THEIR CONSULTANTS SHALL NOT BE HELD RESPONSIBLE FOR THE ACCURACY AND/OR COMPLETENESS OF THAT INFORMATION SHOWN HEREON OR ANY ERRORS OR OMISSIONS RESULTING FROM SUCH.

THE PROPERTY DOES NOT LIE WITHIN THE 100 YEAR FLOOD PLAIN AND IS DETERMINED TO BE IN ZONE "X" AS SHOWN ON FEDERAL EMERGENCY MANAGEMENT AGENCY FIRM NO. 47037C0262H, DATED APRIL 5, 2017.

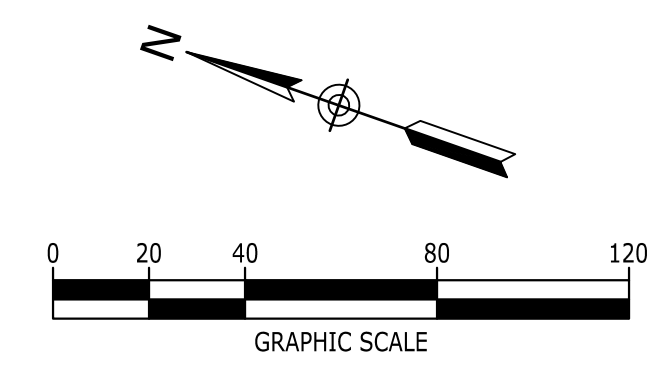

RED SEAL DEVELOPMENT
5202 CENTENNIAL BLVD., #107
NASHVILLE, TN 37209
847.417.5610



CASE NO. 2021SP-037-003
AMENDED PRELIMINARY SP

1908 LEBANON PIKE RESIDENTIAL
1908 LEBANON PIKE
NASHVILLE, DAVIDSON COUNTY, TENNESSEE, 37210

NO.	DATE	DESCRIPTION
12/08/2022	AMENDED PRELIMINARY SP	
06/11/2021	PRELIMINARY SP RESUBMITTAL	
06/02/2021	PRELIMINARY SP RESUBMITTAL	
04/28/2021	PRELIMINARY SP SUBMITTAL	

DRAWING TITLE
EXISTING CONDITIONS

PROJECT NUMBER
20210002

DRAWING NUMBER
C1.0

P:\2021\20210002\0002\Construction\20210002_C5-0_LAY.dwg; C5.0 SITE PLAN Jun 11, 2021 pwilliams



LEGEND	
BUILDING	[Pattern]
CONCRETE PAVEMENT	[Pattern]
CONCRETE SIDEWALK	[Pattern]
HEAVY DUTY PAVEMENT	[Pattern]
LIGHT DUTY PAVEMENT	[Pattern]
PAINTED STRIPE	[Pattern]
CONCRETE CURB	[Pattern]
CENTERLINE	[Pattern]
TACTILE WARNING	[Pattern]

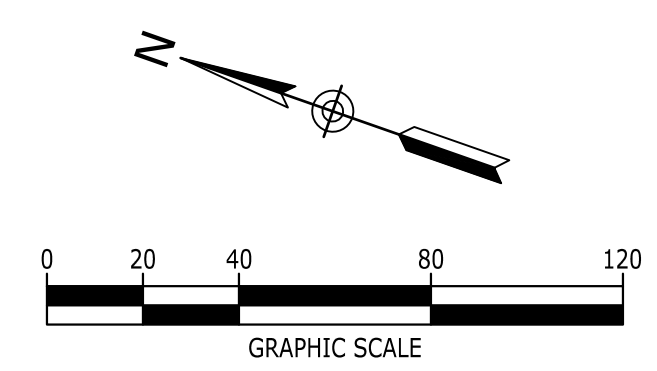

RED SEAL DEVELOPMENT
 5202 CENTENNIAL BLVD., #107
 NASHVILLE, TN 37209
 847.417.5610



CASE NO. 2021SP-037-003
 AMENDED PRELIMINARY SP

1908 LEBANON PIKE RESIDENTIAL
 1908 LEBANON PIKE
 NASHVILLE, DAVIDSON COUNTY, TENNESSEE, 37210

NO.	DATE	DESCRIPTION
12/08/2022		AMENDED PRELIMINARY SP
06/11/2021		PRELIMINARY SP RESUBMITTAL
06/02/2021		PRELIMINARY SP RESUBMITTAL
04/28/2021		PRELIMINARY SP SUBMITTAL

DRAWING TITLE
RENDERED SITE PLAN

PROJECT NUMBER
 20210002

DRAWING NUMBER
C5.0

NO.	DATE	DESCRIPTION
12/08/2022		AMENDED PRELIMINARY SP
06/11/2021		PRELIMINARY SP RESUBMITTAL
06/02/2021		PRELIMINARY SP RESUBMITTAL
04/28/2021		PRELIMINARY SP SUBMITTAL

LINE TABLE

LINE #	LENGTH	BEARING
L1	33.01	S66° 23' 14"W
L2	33.01	S66° 23' 14"W

CURVE TABLE

CURVE #	LENGTH	RADIUS	DELTA	CHORD DIRECTION	CHORD LENGTH
C1	41.37	25.00	94.82	S61° 53' 59"E	36.81
C2	160.56	318.50	28.88	N0° 02' 58"W	158.87
C3	39.27	25.00	90.00	S21° 23' 14"W	35.36
C4	76.99	150.00	29.41	S81° 05' 27"W	76.15
C5	36.20	30.00	69.14	N49° 38' 14"W	34.04
C6	317.92	63.00	289.13	N20° 21' 52"E	73.05
C7	24.55	30.00	46.89	N79° 14' 35"E	23.87
C8	124.18	196.00	36.30	S84° 32' 16"W	122.11
C9	39.27	25.00	90.00	N68° 36' 47"W	35.36

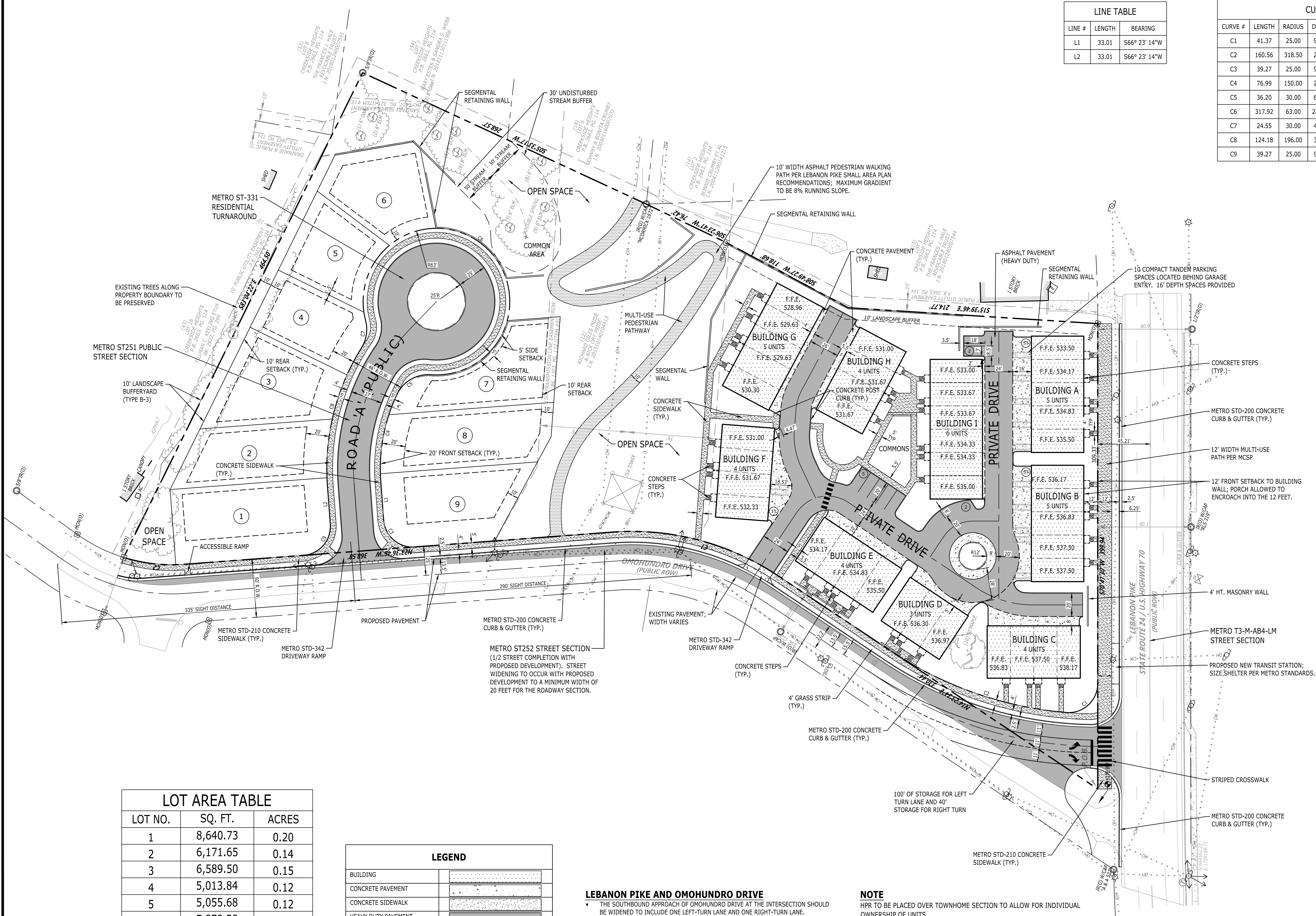

LOT AREA TABLE

LOT NO.	SQ. FT.	ACRES
1	8,640.73	0.20
2	6,171.65	0.14
3	6,589.50	0.15
4	5,013.84	0.12
5	5,055.68	0.12
6	5,879.38	0.13
7	6,663.24	0.15
8	7,157.20	0.16
9	7,314.20	0.17
TOTAL	58,485.42	1.34

LEGEND

BUILDING	[Pattern]
CONCRETE PAVEMENT	[Pattern]
CONCRETE SIDEWALK	[Pattern]
HEAVY DUTY PAVEMENT	[Pattern]
LIGHT DUTY PAVEMENT	[Pattern]
PAINTED STRIPE	[Pattern]
CONCRETE CURB	[Pattern]
CENTERLINE	[Pattern]
TACTILE WARNING	[Pattern]

LEBANON PIKE AND OMOHUNDRO DRIVE

- THE SOUTHBOUND APPROACH OF OMOHUNDRO DRIVE AT THE INTERSECTION SHOULD BE WIDENED TO INCLUDE ONE LEFT-TURN LANE AND ONE RIGHT-TURN LANE.
 - PROVIDE A SOUTHBOUND RIGHT-TURN LANE ON OMOHUNDRO DRIVE WITH A MINIMUM OF 40 FEET OF STORAGE LENGTH.
 - PROVIDE A SOUTHBOUND LEFT-TURN LANE ON OMOHUNDRO DRIVE WITH A MINIMUM OF 100 FEET OF STORAGE LENGTH.
- OMOHUNDRO DRIVE SHOULD BE WIDENED TO 27 FEET PER METRO LOCAL STREET STANDARD.
- THE SOUTHBOUND APPROACH SHOULD BE REALIGNED TO BE PERPENDICULAR WITH LEBANON PIKE TO INCREASE THE SAFETY OF THE INTERSECTION.

NOTE

HPR TO BE PLACED OVER TOWNHOME SECTION TO ALLOW FOR INDIVIDUAL OWNERSHIP OF UNITS.

FINAL LOCATION OF BUS STOP ON LEBANON PIKE SHALL BE DETERMINED WITH FINAL SP.

THE BUFFER ALONG WATERWAYS WILL BE AN AREA WHERE THE SURFACE IS LEFT IN A NATURAL STATE, AND IS NOT DISTURBED BY CONSTRUCTION ACTIVITY. THIS IS IN ACCORDANCE WITH THE STORMWATER MANAGEMENT MANUAL VOLUME 1 - REGULATIONS.

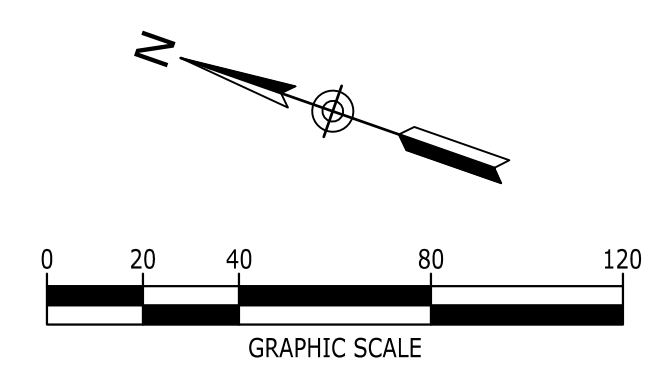

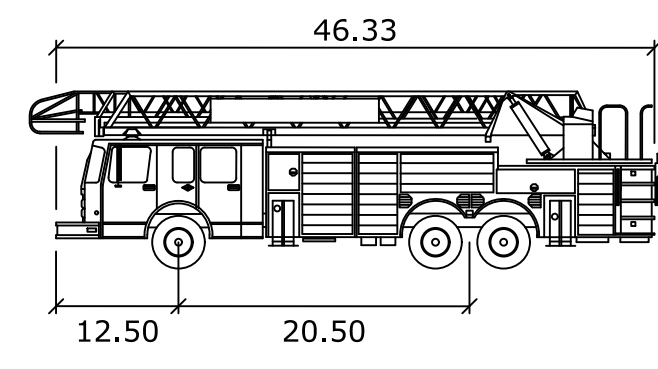

Metro Fire Truck

Width	: 10.00
Track	: 8.33
Lock to Lock Time	: 5.0
Steering Angle	: 42.0

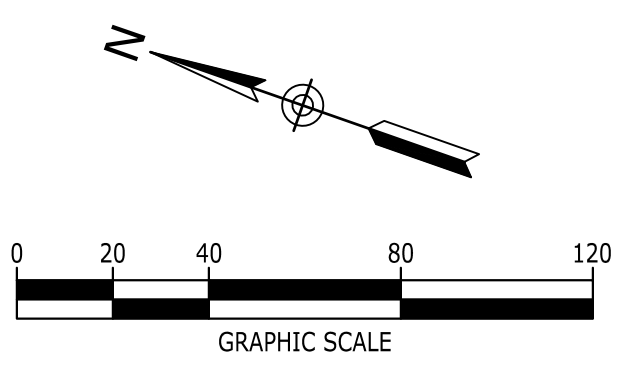

RED SEAL DEVELOPMENT
5202 CENTENNIAL BLVD., #107
NASHVILLE, TN 37209
847.417.5610



CASE NO. 2021SP-037-003
AMENDED PRELIMINARY SP

1908 LEBANON PIKE RESIDENTIAL
1908 LEBANON PIKE
NASHVILLE, DAVIDSON COUNTY, TENNESSEE, 37210

NO.	DATE	DESCRIPTION
12/08/2022	AMENDED PRELIMINARY SP	
06/11/2021	PRELIMINARY SP RESUBMITTAL	
06/02/2021	PRELIMINARY SP RESUBMITTAL	
04/28/2021	PRELIMINARY SP SUBMITTAL	

DRAWING TITLE
FIRE ACCESS PLAN

PROJECT NUMBER
20210002

DRAWING NUMBER
C5.2

P:\2021\20210002\Wvg\Construction\20210002_C6-0_GRA.dwg-C6-0_GRA Jun 11, 2021 pwilliams

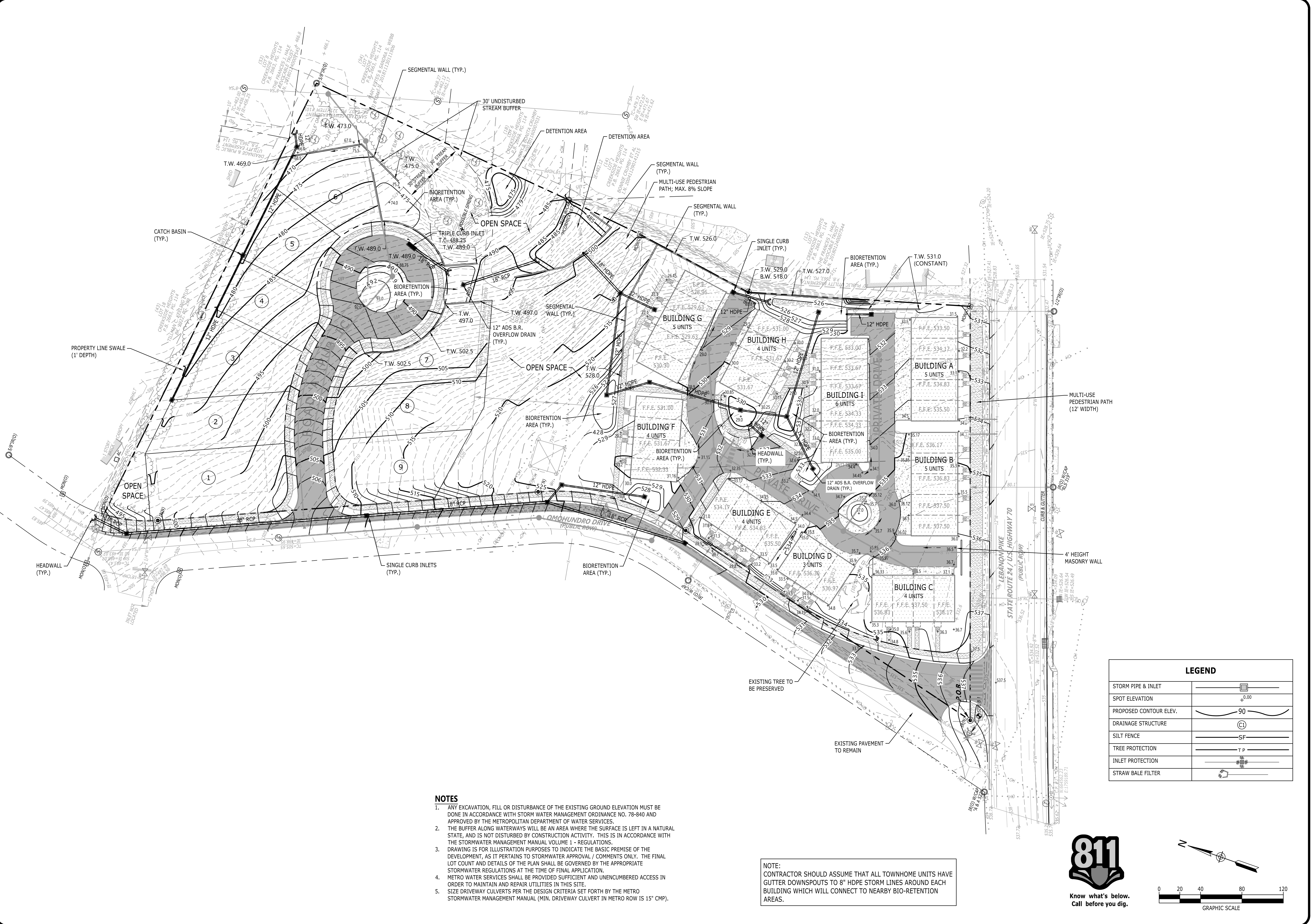

- NOTES**
1. ANY EXCAVATION, FILL OR DISTURBANCE OF THE EXISTING GROUND ELEVATION MUST BE DONE IN ACCORDANCE WITH STORM WATER MANAGEMENT ORDINANCE NO. 78-840 AND APPROVED BY THE METROPOLITAN DEPARTMENT OF WATER SERVICES.
 2. THE BUFFER ALONG WATERWAYS WILL BE AN AREA WHERE THE SURFACE IS LEFT IN A NATURAL STATE, AND IS NOT DISTURBED BY CONSTRUCTION ACTIVITY. THIS IS IN ACCORDANCE WITH THE STORMWATER MANAGEMENT MANUAL VOLUME 1 - REGULATIONS.
 3. DRAWING IS FOR ILLUSTRATION PURPOSES TO INDICATE THE BASIC PREMISE OF THE DEVELOPMENT, AS IT PERTAINS TO STORMWATER APPROVAL / COMMENTS ONLY. THE FINAL LOT COUNT AND DETAILS OF THE PLAN SHALL BE GOVERNED BY THE APPROPRIATE STORMWATER REGULATIONS AT THE TIME OF FINAL APPLICATION.
 4. METRO WATER SERVICES SHALL BE PROVIDED SUFFICIENT AND UNENCUMBERED ACCESS IN ORDER TO MAINTAIN AND REPAIR UTILITIES IN THIS SITE.
 5. SIZE DRIVEWAY CULVERTS PER THE DESIGN CRITERIA SET FORTH BY THE METRO STORMWATER MANAGEMENT MANUAL (MIN. DRIVEWAY CULVERT IN METRO ROW IS 15" CMP).

NOTE:
CONTRACTOR SHOULD ASSUME THAT ALL TOWNHOME UNITS HAVE GUTTER DOWNSPOUTS TO 8" HDPE STORM LINES AROUND EACH BUILDING WHICH WILL CONNECT TO NEARBY BIO-RETENTION AREAS.

LEGEND	
STORM PIPE & INLET	
SPOT ELEVATION	+0.00
PROPOSED CONTOUR ELEV.	90
DRAINAGE STRUCTURE	
SILT FENCE	SF
TREE PROTECTION	TP
INLET PROTECTION	
STRAW BALE FILTER	

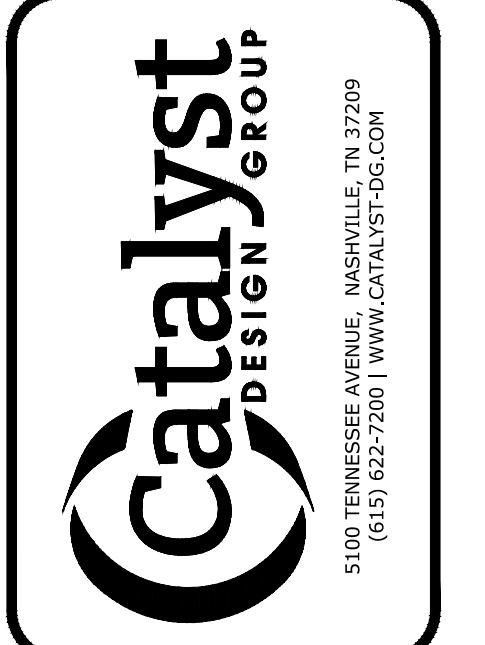
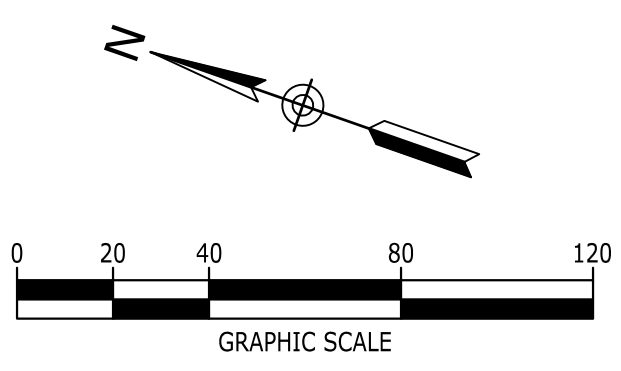

RED SEAL DEVELOPMENT
5202 CENTENNIAL BLVD., #107
NASHVILLE, TN 37209
847.417.5650



CASE NO. 2021SP-037-003
AMENDED PRELIMINARY SP

1908 LEBANON PIKE RESIDENTIAL
1908 LEBANON PIKE
NASHVILLE, DAVIDSON COUNTY, TENNESSEE, 37210

NO.	DATE	DESCRIPTION
12/08/2020	AMENDED PRELIMINARY SP	
06/11/2021	PRELIMINARY SP RESUBMITTAL	
06/02/2021	PRELIMINARY SP RESUBMITTAL	
04/28/2021	PRELIMINARY SP SUBMITTAL	

DRAWING TITLE
SITE GRADING & DRAINAGE

PROJECT NUMBER
20210002

DRAWING NUMBER
C6.0

P:\2021\20210002.dwg\Construction\20210002_C7-0_Utility.dwg-C7-0_Utility PLAN Jun 11, 2021 pwilliams

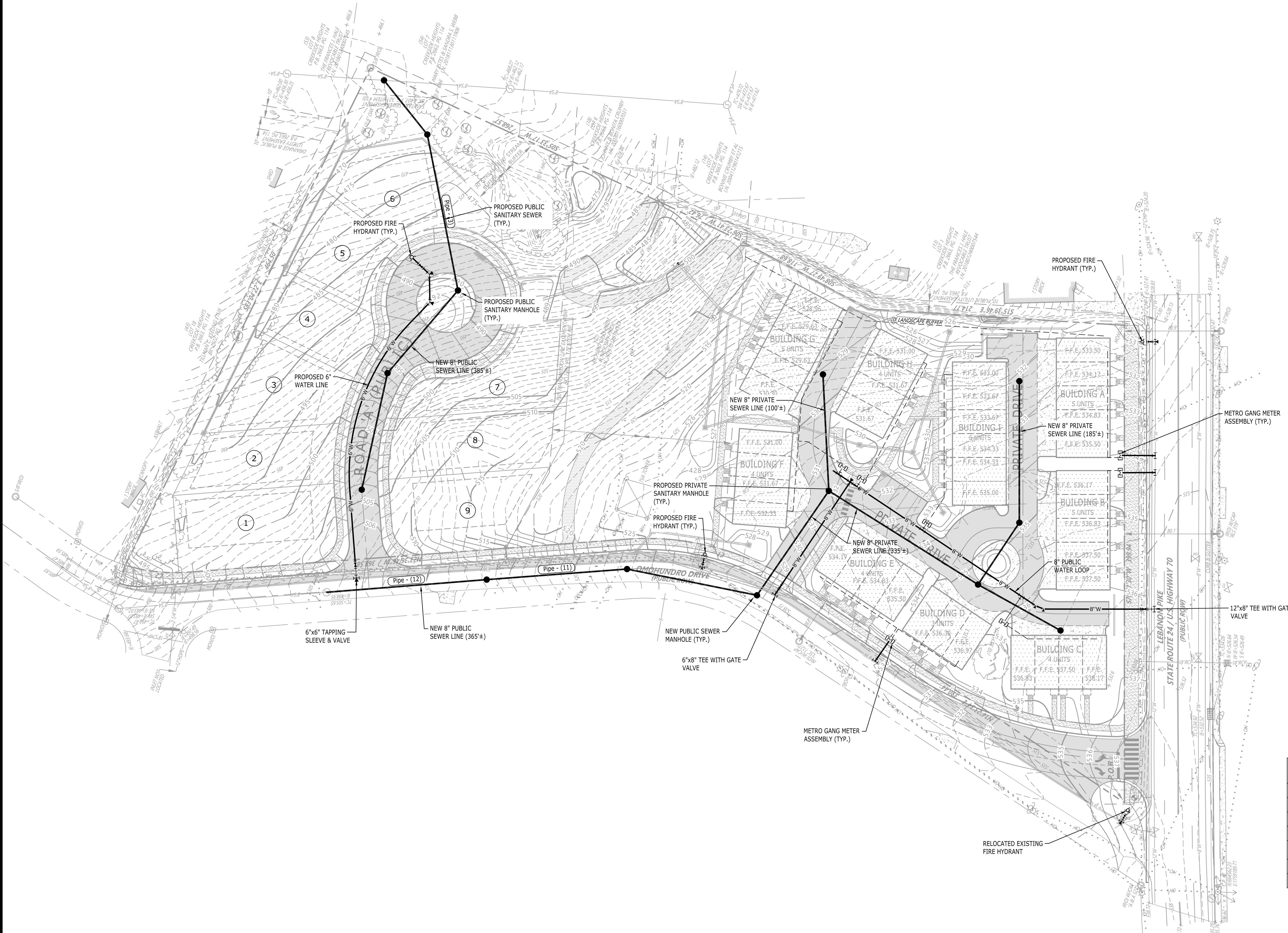

LEGEND	
DOMESTIC WATER SERVICE	— W —
FIRE SERVICE	— F — F
GAS LINE	— GAS —
THRUST BLOCK	— T —
CLEANOUT ON SANITARY SEWER LINE	— C —
PROPOSED FIRE HYDRANT	— F —
UNDERGROUND ELECTRIC	— UGE — UGE

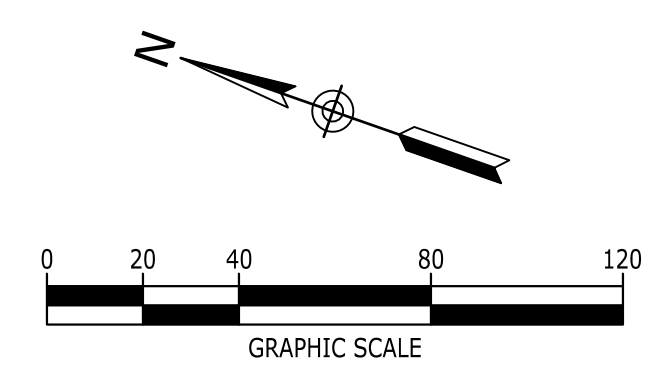

RED SEAL
DEVELOPMENT
 5202 CENTENNIAL BLVD., #107
 NASHVILLE, TN 37209
 847.417.5610



CASE NO. 2021SP-037-003
 AMENDED PRELIMINARY SP

1908 LEBANON PIKE RESIDENTIAL
 1908 LEBANON PIKE
 NASHVILLE, DAVIDSON COUNTY, TENNESSEE,
 37210

NO.	DATE	DESCRIPTION
12/08/2022		AMENDED PRELIMINARY SP
06/11/2021		PRELIMINARY SP RESUBMITTAL
06/02/2021		PRELIMINARY SP RESUBMITTAL
04/28/2021		PRELIMINARY SP SUBMITTAL

DRAWING TITLE
SITE UTILITIES

PROJECT NUMBER
 20210002

DRAWING NUMBER
C7.0

P:\2021\20210002\0002\Construction\20210002_L1-0_LANDSCAPE.L1-0_LANDSCAPE.PLAN Jun 11, 2021 2:11:21 PM Williams

PRESERVED TREES

TREE NUMBER	SIZE (DBH-INCHES)	COMMON NAME
1	6	OAK
2	8	ELM
3	8	OAK
4	6	OAK
5	8	ELM
6	8	ELM
7	6	ELM
8	6	HACKBERRY
9	6	ELM
10	50	MAPLE

TREE DENSITY UNIT WORKSHEET

DATE	04.28.2021
MAP & PARCEL	MAP 95-09, PARCELS 11 & 12
APPLICATION NUMBER	TO BE ASSIGNED
PROJECT NAME	1908 LEBANON PIKE RESIDENTIAL
ADDRESS	1908 LEBANON PIKE
ACREAGE	5.63 AC.
BUILDING COVERAGE	1.20 AC.
REQUIRED DENSITY	SINGLE FAM. 14; TOWNHOMES 22
TOTAL REQUIRED TDU	(SINGLE FAM.) 2.46 x 14 = 34.44 (TOWNHOMES) 1.97 x 22 = 43.34

RETAINED HERITAGE TREES			
DBH	#	VALUE	TDU
50"	1	20.0	20.0

RETAINED TREES			
DBH	#	VALUE	TDU
6"	5	1.8	9.0
8"	4	2.4	9.6
10"		3	0
12"		3.6	0
14"		4.2	0
16"		4.8	0
18"		5.4	0
20"		6	0
22"		6.6	0
24"		8.4	0
26"		9.1	0
28"		9.8	0
30"		10.5	0

REPLACEMENT TREES - LARGE & MEDIUM CANOPY TREES			
DBH	#	VALUE	TDU
2"	25	0.5	12.5
3"	30	0.6	18.0
4"		0.7	0
5"		0.9	0
6"		1	0
7"		1.2	0
8"		1.3	0

REPLACEMENT TREES - COLUMNAR & UNDERSTORY TREES			
DBH	#	VALUE	TDU
2"	37	0.25	9.25
3"		0.3	0
4"		0.4	0
5"		0.5	0
6"		0.5	0
7"		0.6	0
8"		0.7	0

TOTAL RETAINED TDU	38.60
TOTAL REPLACED TDU	39.75
TOTAL TDU PROVIDED	78.35

NOTES

- LANDSCAPING AND TREE DENSITY REQUIREMENTS PER METRO ZONING ORDINANCE SHALL BE MET.
- FINAL LANDSCAPE PLAN SHALL BE APPROVED AT FINAL SP APPROVAL.

LANDSCAPE KEYNOTES

CODE	DESCRIPTION	DET #/SHT #
L1	PLANTING BED LIMITS	
L2	IRRIGATION LIMITS	
L3	AREA TO BE SEEDED	
L4	AREA TO BE SODDED	
L5	AREA TO BE 4"-6" RIVER ROCK	



RED SEAL DEVELOPMENT
5202 CENTENNIAL BLVD., #107
NASHVILLE, TN 37209
847.417.5610



CASE NO. 2021SP-037-003
AMENDED PRELIMINARY SP
1908 LEBANON PIKE RESIDENTIAL
1908 LEBANON PIKE
NASHVILLE, DAVIDSON COUNTY, TENNESSEE, 37210

NO.	DATE	DESCRIPTION
12/08/2021	AMENDED PRELIMINARY SP	
06/11/2021	PRELIMINARY SP RESUBMITTAL	
06/02/2021	PRELIMINARY SP RESUBMITTAL	
04/28/2021	PRELIMINARY SP RESUBMITTAL	

DRAWING TITLE
SITE LANDSCAPE

PROJECT NUMBER
20210002
DRAWING NUMBER
L1.0

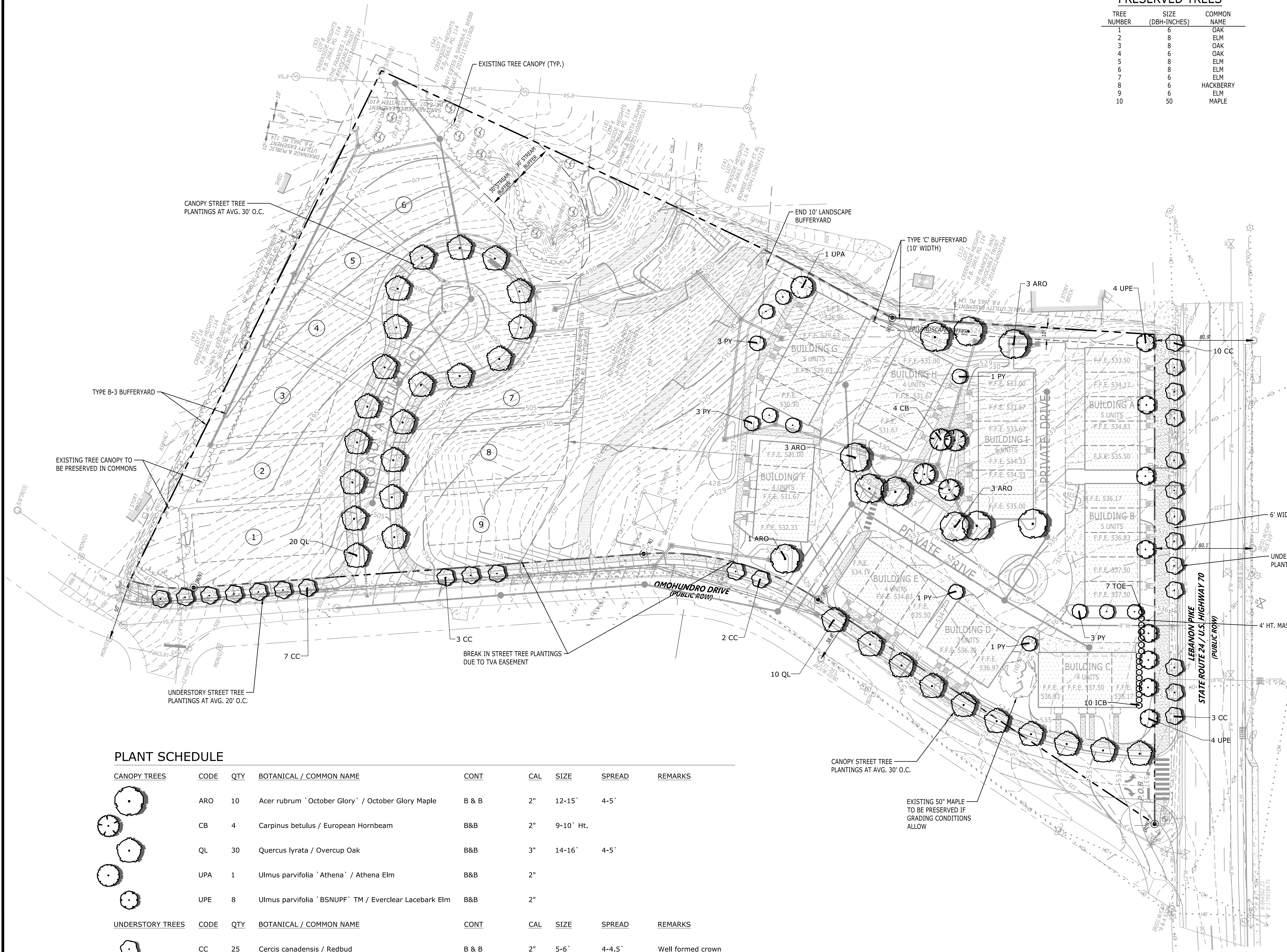

PLANT SCHEDULE

CANOPY TREES	CODE	QTY	BOTANICAL / COMMON NAME	CONT	CAL	SIZE	SPREAD	REMARKS
	ARO	10	Acer rubrum 'October Glory' / October Glory Maple	B & B	2"	12-15'	4-5'	
	CB	4	Carpinus betulus / European Hornbeam	B&B	2"	9-10' Ht.		
	QL	30	Quercus lyrata / Overcup Oak	B&B	3"	14-16'	4-5'	
	UPA	1	Ulmus parvifolia 'Athena' / Athena Elm	B&B	2"			
	UPE	8	Ulmus parvifolia 'BSNUPF' TM / Everclear Lacebark Elm	B&B	2"			
	CC	25	Cercis canadensis / Redbud	B & B	2"	5-6'	4-4.5'	Well formed crown
	PY	12	Prunus x yedoensis / Yoshino Cherry	B&B	2"	8-10'	3-4'	
	ICB	10	Ilex cornuta 'Burfordii Nana' / Dwarf Burford Holly	#7 Cont.		24-30"	27-30"	
	TOE	7	Thuja occidentalis 'Emerald' / Emerald Arborvitae	#20 Cont./B&B		6-7'		

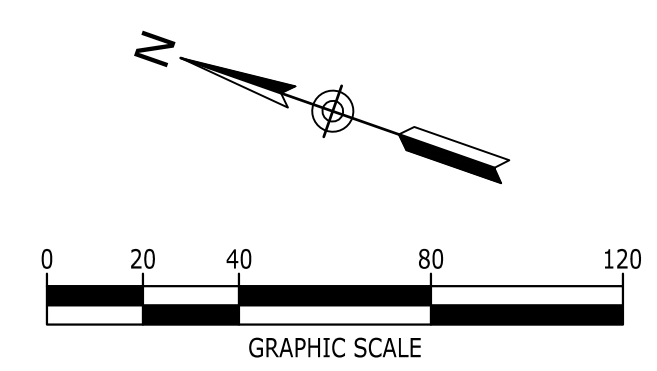



BLDG C SIDE, BLDS B & A FRONT

NOTE: REFER TO FOLLOWING SHEETS.



BLDG C FRONT

NOTE: REFER TO FOLLOWING SHEETS.



BLDGS E & D FRONT

NOTE: REFER TO FOLLOWING SHEETS.



BLDG F SIDE

NOTE: REFER TO FOLLOWING SHEETS.



SINGLE FAMILY - 3 STORY



SINGLE FAMILY - 2 STORY

1908 LEBANON PIKE
STREET ADDRESS | CITY | STATE | ZIP

REVISIONS

No.	Description	Date
-----	-------------	------

SP

NOT FOR CONSTRUCTION

SP ELEVATIONS

A4.1

NOTE: ALL ELEVATIONS ARE TAKEN FROM FFE AND STOOP ELEVATION WILL BE 18" - 36" FROM GRADE.





04 BUILDING A - LEFT ELEVATION



03 BUILDING A - REAR ELEVATION



02 BUILDING A - RIGHT ELEVATION



01 BUILDING A - FRONT ELEVATION

TOTAL SF: 3,560 SF
GLAZING: 716 SF
20.1% GLAZING

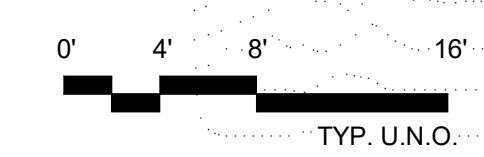

REVISIONS

No.	Description	Date

SP SUBMISSION

BLDG A - ELEVATIONS

A0.2.1



04 BUILDING B - RIGHT ELEVATION



03 BUILDING B - REAR ELEVATION



02 BUILDING B - LEFT ELEVATION



01 BUILDING B - FRONT ELEVATION

TOTAL SF: 3,560 SF
GLAZING: 716 SF
20.1% GLAZING

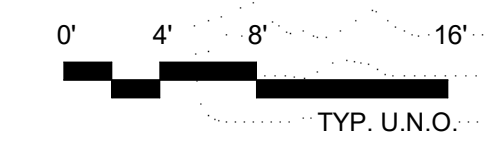

REVISIONS

No.	Description	Date
	SP SUBMISSION	

BLDG B - ELEVATIONS

A0.3.1



04 BUILDING C - RIGHT ELEVATION

TOTAL SF: 1,451 SF
GLAZING: 288 SF
20.0% GLAZING



03 BUILDING C - REAR ELEVATION



02 BUILDING C - LEFT ELEVATION



01 BUILDING C - WEST ELEVATION

TOTAL SF: 3,560 SF
GLAZING: 716 SF
20.1% GLAZING

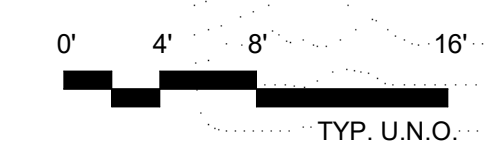

REVISIONS

No.	Description	Date
	SP SUBMISSION	

BLDG C - ELEVATIONS

A0.4.1



04 BUILDING D - RIGHT ELEVATION



03 BUILDING D - REAR ELEVATION



02 BUILDING D - LEFT ELEVATION



01 BUILDING D - FRONT ELEVATION

TOTAL SF: 2150 SF
GLAZING: 429 SF
20.0% GLAZING

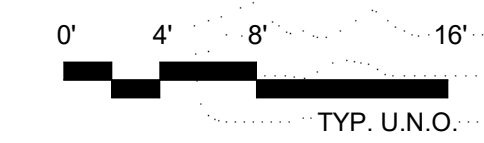

1908 LEBANON PIKE
1908 LEBANON PIKE | NASHVILLE | TENNESSEE | 37027

REVISIONS

No.	Description	Date
	SP SUBMISSION	

BLDG D - ELEVATIONS

A0.5.1



04 BUILDING E - RIGHT ELEVATION



03 BUILDING E - REAR ELEVATION

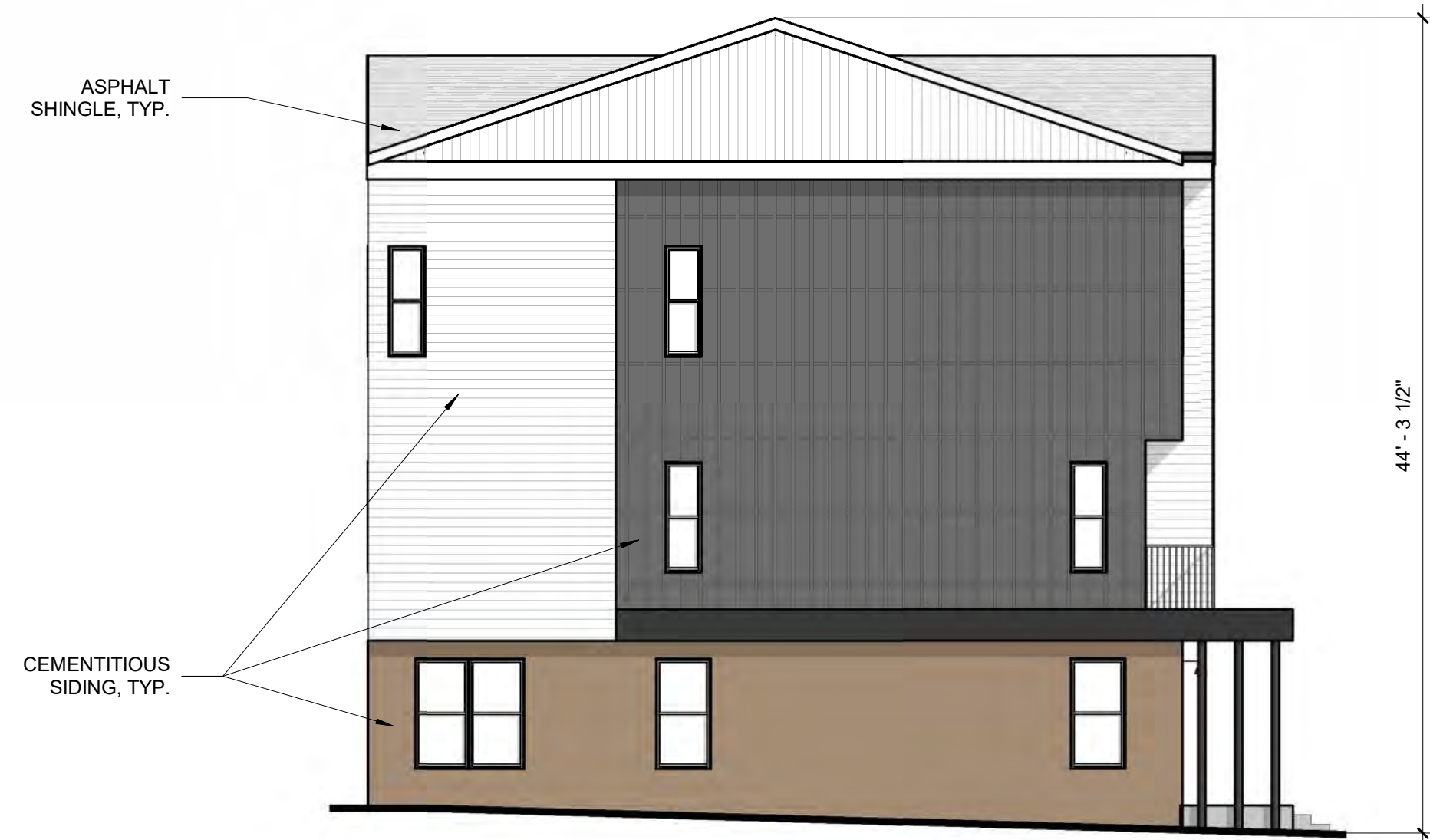

02 BUILDING E - LEFT ELEVATION



01 BUILDING E - FRONT ELEVATION

TOTAL SF: 2869 SF
GLAZING: 572 SF
20.0% GLAZING

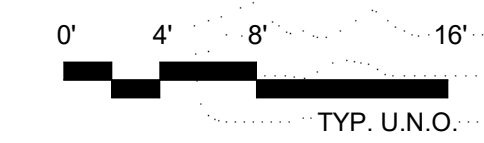

REVISIONS

No.	Description	Date
	SP SUBMISSION	



04 BUILDING F - RIGHT ELEVATION



03 BUILDING F - REAR ELEVATION



02 BUILDING F - LEFT ELEVATION



01 BUILDING F - FRONT ELEVATION

1908 LEBANON PIKE
1908 LEBANON PIKE | NASHVILLE | TENNESSEE | 37027

REVISIONS

No.	Description	Date
	SP SUBMISSION	

BLDG F - ELEVATIONS

A0.7.1

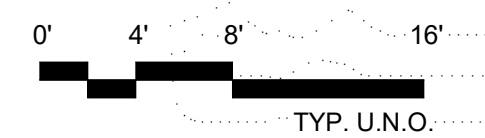



04 BUILDING G - LEFT ELEVATION



03 BUILDING G - REAR ELEVATION



02 BUILDING G - RIGHT ELEVATION



01 BUILDING G - FRONT ELEVATION

REVISIONS

No.	Description	Date
	SP SUBMISSION	

BLDG G - ELEVATIONS

A0.8.1

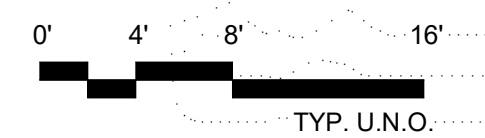



04 BUILDING H - RIGHT ELEVATION



03 BUILDING H - REAR ELEVATION



02 BUILDING H - LEFT ELEVATION



01 BUILDING H - FRONT ELEVATION

REVISIONS

No.	Description	Date
	SP SUBMISSION	

BLDG H - ELEVATIONS

A0.9.1

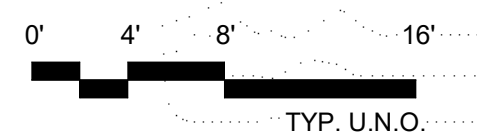



04 BUILDING I - RIGHT ELEVATION



03 BUILDING I - REAR ELEVATION



02 BUILDING I - LEFT ELEVATION



01 BUILDING I - FRONT ELEVATION

REVISIONS

No.	Description	Date
	SP SUBMISSION	

BLDG I - ELEVATIONS

A0.10.1

SP# 2016SP-043-004
PROJECT# 21009 7/28/2022

