

Text Amendment 2023Z-003TX-001
Downtown Code Amendment

Appendix A

Full DTC Document w/ Proposed Revisions

The following pages include the full DTC document as is currently adopted, with changes proposed as part of this text amendment noted by a red dashed outline. These proposed changes can be found on pages 14, 82, and 88-110.

NASHVILLE DOWNTOWN CODE

Chapter 17.37 of the Metropolitan Nashville and Davidson County Zoning Code

Attachment to Ordinance No. BL2009-586
as adopted on February 02, 2010

Amended by Ordinance No. BL2011-896
as adopted on May 17, 2011

Amended by Ordinance No. BL2012-142
as adopted on May 15, 2012

Amended by Ordinance No. BL2013-376
as adopted on March 19, 2013

Amended by Ordinance No. BL2015-1048
as adopted on April 21, 2015

Amended by Ordinance No. BL2015-1053
as adopted on August 04, 2015

Amended by Ordinance No. BL2015-1253
as adopted on August 18, 2015

Amended by Ordinance No. BL2016-133
as adopted on September 06, 2016

Amended by Ordinance No. BL2017-827
as adopted on August 15, 2017

Amended by Ordinance No. BL2020-334
as adopted on August 21, 2020

Amended by Ordinance No. BL2021-868
as adopted on October 19, 2021

Amended by Ordinance No. BL2021-869
as adopted on October 19, 2021

Amended by Ordinance No. BL2021-923
as adopted on November 16, 2021

Amended by Ordinance No. BL2022-1412
as adopted on November 15, 2022

Amended by Ordinance No. BL2022-1472
as adopted on November 15, 2022

Amended by Ordinance No. BL2024-452
as adopted on August 20, 2024

Document Contact Information

Planning Department staff provides consultations for developing within the Downtown Code.

Call (615) 862-7190 or email planningstaff@nashville.gov to schedule a meeting.



The Planning Department does not discriminate on the basis of age, race, sex, color, national origin, religion or disability in access to, or operation of, its programs, services, and activities, or in its hiring or employment practices. For ADA inquiries, contact Randi Semrick, ADA Compliance Coordinator, at (615) 862-7230 or e-mail her at randi.semrick@nashville.gov. For Title VI inquiries contact Shirley Sims-Saldana or Denise Hopgood of Human Relations at (615) 880-3370. For all employment-related inquiries call (615) 862-6640.

Section I: Introduction

Table of Contents

Section I: Introduction	5		
The Downtown Code and the Downtown Plan	6	Parking and Access	82
DTC Regulating Plan	11	Specific to Structured Parking	83
Application of the DTC	12	Specific to Surface Parking	84
General Provisions	12	Mechanical, Service and Loading	85
Applicable Chapters and Sections of the Zoning Code	12	Fences and Walls	86
How to Use this Document	13	Open Space	87
Modifications	14	Plan	88
Design Review and Compliance	15	General Standards	89
		Specific to Greens	90
		Specific to Squares	91
		Specific to Plazas	92
		Specific to Courts	93
		Specific to Pocket Parks and Playgrounds	94
		Bonus Height Program	95
		BHP Chart	100
Section II: Subdistrict Standards	17		
James Robertson Subdistrict	18	Section V: Sign Standards	102
Core Subdistrict	20	Introductory Provisions	103
Core Historic Subdistrict	22	Intent	103
Upper Broadway Subdistrict	26	Applicability	103
2nd and Broadway Subdistrict	28	Sign Permit Applications	103
River Subdistrict	32	Common Sign Plan	103
SoBro Subdistrict	34	Modifications	104
Lafayette Subdistrict	38	Right-of-way Encroachments	104
Rutledge Hill Subdistrict	40	Nonconforming Signs	104
Rolling Mill Hill Subdistrict	42	Repair and Maintenance	105
Rutledge River Subdistrict	44	General Standards	105
Gulch North Subdistrict	46	Other Sign Types	105
Gulch South Subdistrict	48	Street Types	106
Hope Gardens Subdistrict	50	Street Types Map	107
Sulphur Dell Subdistrict	52	Determining Street Entitlements	108
East Bank Subdistrict	54	Allocation of Sign Area by Street Types	109-110
		Building Signs	111
Section III: Uses	59	Wall Sign	111
Use Areas	60	Awning Sign	112
Use Tables	61	Canopy Sign	113
		Projecting Sign	114
Section IV: General Standards	63	Shingle Sign	115
Calculations	64	Ground Signs	116
Street Character	65	Monument Sign	116
Future Streets Plan	69	Skyline Signs	117
Lots and Frontages	70	Illumination	118
Specific to Storefront Frontage	72	Changeable Copy	119
Specific to Stoop Frontage	74		
Specific to Porch Frontage	76		
Specific to Industrial Frontage	78		
Specific to Civic Frontage	80		
Canopies and Awnings	81		

This page left intentionally blank

Section I : Introduction

Section I: Introduction

The Downtown Code and the Downtown Plan

The Downtown Code (DTC) implements the community vision set forth in the Downtown Community Plan: 2007 Update. Through the community planning process, stakeholders reached a common vision for the future of Downtown. The Plan envisions multiple distinct neighborhoods within Downtown, each with its own character and scale, which contribute to the vitality of Downtown as the center of the city and the region.

The DTC regulates the physical form of buildings to ensure each makes a positive contribution to a complete urban environment. By ensuring a specific and predictable urban form, the DTC ensures that all new construction makes a positive contribution to the public realm – streets and open space – and that all investments are held to the same standard.

While the DTC is a regulating document, the Downtown Plan contains placemaking tools and guidelines and should be used as a companion document to the DTC.

The Guiding Principles of the Downtown Plan have directed the standards in the DTC and are as follows:

Ensure that Downtown remains the civic, commercial and entertainment center for Nashville, Middle Tennessee and the Southeast.

- The regulations of the DTC clarify the vision for each neighborhood in Downtown. Under the DTC, certain areas are allowed to have high-rise towers, while others are zoned for neighborhood-scale development, while still others are allowed to be more transitional with support uses necessary to sustain urban business.
- In recent years, nearly all projects in Downtown have sought rezoning or variances to existing zoning. The DTC alleviates this need by allowing significantly greater development rights, in forms based on construction norms and urban design objectives, than existing zoning. The DTC also allows the modification of standards for site-specific issues.

Provide opportunities for continued growth while preserving and enhancing the character that inspires residents and businesses to move Downtown.

- The Downtown Plan called for areas of increased height and density within Downtown. The Plan extended the boundaries of the Core – the tallest and most intense neighborhood – and provided guidance regarding additional height in other neighborhoods. The DTC codifies these opportunities in the subdistrict standards for these neighborhoods.
- Similarly, the Downtown Plan acknowledged the difficulty of developing within the sky exposure plane in some neighborhoods. The DTC modified the allowable form of buildings by allowing additional height at the street in exchange for an overall height-cap. The result is that properties, and

thus neighborhoods, will have the same intensity as in CF zoning but in a form that is aligned with typical construction methods and creates a more predictable urban environment.

- The form and shape of development under CC and CF zoning is unpredictable. The DTC provides clear direction on minimum development and maximum development. For instance, the Gulch is zoned for a specific character, while Sulphur Dell is zoned for something different. This ensures certainty about the character and scale of development in each neighborhood.
- In an urban environment, the street level design and function of a building is of the utmost importance. The interaction of the building with the street should enliven the street, making it comfortable, safe and interesting for pedestrians. The DTC is based on frontage design – storefront, stoop, porch, industrial, and civic – and includes standards on glazing, vehicular access, landscaping, and active uses on the ground level. Correctly designed, these attributes will contribute to safe and interesting streets to result in vibrant neighborhoods and a healthy Downtown.
- A safe and interesting urban environment attracts people. People who feel comfortable in Downtown – enjoying available activities, prospering from the businesses and services, and lingering in the spaces and places – want to be Downtown. The DTC fosters this desirable urban environment through the attention to pedestrian-oriented design, appropriate scale and massing, and neighborhood creation.

Create strategic mixed use to facilitate Downtown's transformation into a 24/7 community.

Section I: Introduction

The Downtown Code and the Downtown Plan

- The Plan calls for a “thoughtful mixture of uses including residential, retail and office, to ensure that Downtown doesn’t close at 5 p.m. or even after the concert ends or the restaurants close, but is instead a welcoming home for a diverse residential population.” Multiple stories encourage multiple uses within each building, increasing the likelihood that one of the uses will be active at any given hour. Compare this to one story buildings which lack activity during the off-hours of the single use.
- To be viable, Downtown must accommodate numerous services and functions. By promoting form over use, the DTC allows for a mixture of uses. Because various functions occur at different times of the day – working, shopping and recreating during the day, entertainment and home-life at night – mixed-use, 24/7 neighborhoods use existing infrastructure more efficiently and function in a more sustainable way.
- “Since 2000, Downtown has experienced an unprecedented residential boom. In 2000, there were approximately 1500 dwelling units in Downtown. As of 2006, over 2600 new residential units were under construction, planned or proposed...Since 2000 there has been over \$500 million in capital investments in residential construction, with another \$400 million planned or proposed.” In addition, “since 2000, Downtown office building development has grown modestly with \$140 million of development completely or under construction.” These strong numbers increase the viability of Downtown. To continue this good momentum, the emphasis must be on place-making as well as development. The DTC encourages the creation of mixed-use, sustainable neighborhoods that have flexibility to address the needs of citizens over time.

Create and nurture urban neighborhoods.

- As stated in the Plan, “While residential *development* has flourished in recent years, the creation and enhancement of urban *neighborhoods* is still a goal. Residential living will thrive in Downtown when residents feel that they are part of a neighborhood, supported by shared public spaces and the services and amenities needed for daily life.” The DTC directly addresses the development characteristics of neighborhood design: building mass and scale, frontage design, and open space design.
- To create these distinctive urban neighborhoods, the DTC aligns the regulations of each subdistrict with the intended character of the neighborhood. For instance, the South Gulch is envisioned to continue as a high-rise and mid-rise, mixed-use neighborhood. The DTC codifies mid-rise height in the general subdistrict and allows high-rise buildings on key intersections and along important streets. In contrast, the North Gulch is envisioned to be a low-rise neighborhood – to preserve Capitol views and transition into the Hope Gardens and John Henry Hale neighborhoods. The DTC codifies this vision by capping the overall height, allowing for less intense development such as two story houses and townhouses, and encouraging porch and stoop frontages. These are two examples of how the DTC aligns the zoning of neighborhoods with the vision cast during the community planning process.
- “...the Downtown Plan encourages walking as a primary mode of transportation in Downtown. Walking is encouraged in the Downtown Plan by making the walk safe, interesting, and comfortable...” Streets are the most plentiful open space in Downtown and should prioritize the pedestrian experience while appropriately accommodating vehicular traffic. The DTC emphasizes frontage design, requires active ground level uses, and sets standards for vehicular activity.
- The DTC prioritizes the location of vehicular access points per street type – Primary, Secondary, Tertiary, Other, and Alley. By prioritizing, instead of regulating, the DTC allows flexibility for site-specific solutions to be reached in collaboration between the developer and Metro departments.
- While the DTC sets standards on the development of private property, active and attractive streets must be created by a collaborative process with all Metro Departments. As development proposals are offered, Metro will retain a commitment to creating a strong pedestrian-oriented urban environment. “As Downtown becomes home to many of its workers, and mass transit options into Downtown improve, providing welcoming routes for pedestrians will provide benefits in terms of improved mobility and reduced traffic congestion.”

Section I: Introduction

The Downtown Code and the Downtown Plan

- The DTC references the Downtown Streetscape Design Guidelines, and the Major and Collector Street Plan created by Metro Public Works and Metro Planning, and requires their use.

Protect and reuse historic structures and districts.

- The DTC has a subdistrict for 2nd Avenue and Lower Broadway that reinforces the historic zoning overlay for these streets. To encourage the adaptive reuse of the historic structures, this subdistrict is eligible for transfer of development rights through the Bonus Height Program.
- The creation of the Core Historic subdistrict encourages the preservation of the existing historic buildings between 3rd and 5th Avenues North, while allowing for appropriately scaled and appropriately detailed infill.
- The creation of the Rutledge Hill subdistrict encourages the preservation of the existing historic buildings in this historic residential area, while allowing for appropriately scaled and appropriately detailed infill.
- During the community planning process, the preservation of views to the Capitol building was identified as important to the development of neighborhoods north of Capitol Hill. The maximum building heights in subdistricts north of Capitol Hill are limited to the elevation of the base of the Capitol building to ensure this that this important civic view is preserved.

Create environmentally sustainable and energy efficient development.

- In order to meet the sustainability goals of the Downtown Plan and to achieve Metro Government's vision of Nashville as the greenest city in the US, the DTC encourages urban infill and energy efficient development.
- By location alone, urban infill is more energy efficient than green-field development because it utilizes existing streets and infrastructure. By emphasizing mixed-use, walkable neighborhoods within Downtown, the DTC reinforces Metro Government's commitment to sustainability and responsible use of resources. Part of being sustainable is using existing under-utilized infrastructure – water lines, sewer lines, electricity, and streets – in lieu of creating new infrastructure and continuing green-field consumption.

- Location, however, does not ensure sustainability. The creation of the DTC emphasizes the need for a denser Downtown to provide citizens with all daily needs within walking distance, the need for buildings that can be adapted for new uses over time, the preservation and adaptive reuse of existing buildings, and the addition of street trees and open spaces.
- In addition to encouraging sustainable urbanity, the DTC encourages the measurement of energy efficient development through the US Green Building Council's LEED program. (LEED may be substituted for a different nationally-recognized, third-party system of overseeing green building and/or sustainable development practices.)
- The Bonus Height Program of the DTC provides height bonuses for new construction that meets the standards of LEED silver, gold or platinum. LEED takes credits a project for its urban environment, but also for the sustainability of the building itself. The public benefit associated with LEED certification is significant. The lighter the building treads on the infrastructure of the city, the lighter the burden on the city to maintain the infrastructure. This helps the city function better as a whole. The bonuses are appropriately scaled for each subdistrict and are offered in exchange for the level of contribution of this important public benefit.

Create “great spaces” throughout Downtown for the enjoyment of citizens and visitors.

- In some areas of Downtown, open space is appropriately scaled and designed for the envisioned intensity of the neighborhood. In most areas, however, open space is dramatically lacking. The DTC identifies ¼ mile radius neighborhoods (about a five minute walk from edge to center) within Downtown to show the open space deficiencies. For every quarter mile neighborhood, there should be at least a quarter acre of well-designed public open space. This open space may be provided by public or private initiatives.
- The Downtown Plan recommended that Downtown have unique types of open space available to meet the needs of citizens. The DTC provides standards for the creation of these open spaces: greens, squares, plazas, courts and pocket parks/ playgrounds. The open spaces will serve as important “great spaces” to help create the vital and functioning neighborhoods envisioned by the

Section I: Introduction

The Downtown Code and the Downtown Plan

Downtown Plan.

- The Bonus Height Program of the DTC provides height bonuses for the development of public open spaces. To be eligible for the height bonus, the development must follow the standards for open space design. The bonuses are appropriately scaled for each subdistrict and are offered in exchange for this important public amenity.

Provide for improved mobility in and through Downtown to support other principles for healthy growth in Downtown.

- “The Downtown Plan encourages walking as a primary mode of transportation in Downtown.” The DTC standards focus on the interaction between the building and street – the frontage of the building – to make the pedestrian realm safe, comfortable and interesting. This goal will be reached when public and private entities remain committed to creating a pedestrian-oriented Downtown.
- The Downtown Plan notes that “as Downtown becomes home to many of its workers, and mass transit options into Downtown improve, providing welcoming routes for pedestrians will provide benefits in terms of improved mobility and reduced traffic congestion.” While the DTC sets standards on the development of private property, improved transportation options must be created by a collaborative process between the public and private sectors.

The Downtown Plan sets forth the common vision for the future of Downtown, and acknowledges that “the creation of the Downtown envisioned by the community can only be achieved through cooperative efforts of the public and private sectors and through the informed involvement of residents, businesses and investors in Downtown. Adherence to these guiding principles in the development actions of both the public and private sector will create the Downtown Nashville that the community has envisioned – an expanding, vibrant Downtown with opportunities for growth and development that embody the urban experience of a great city.” The DTC is one of several tools to strengthen Downtown through public and private investments.









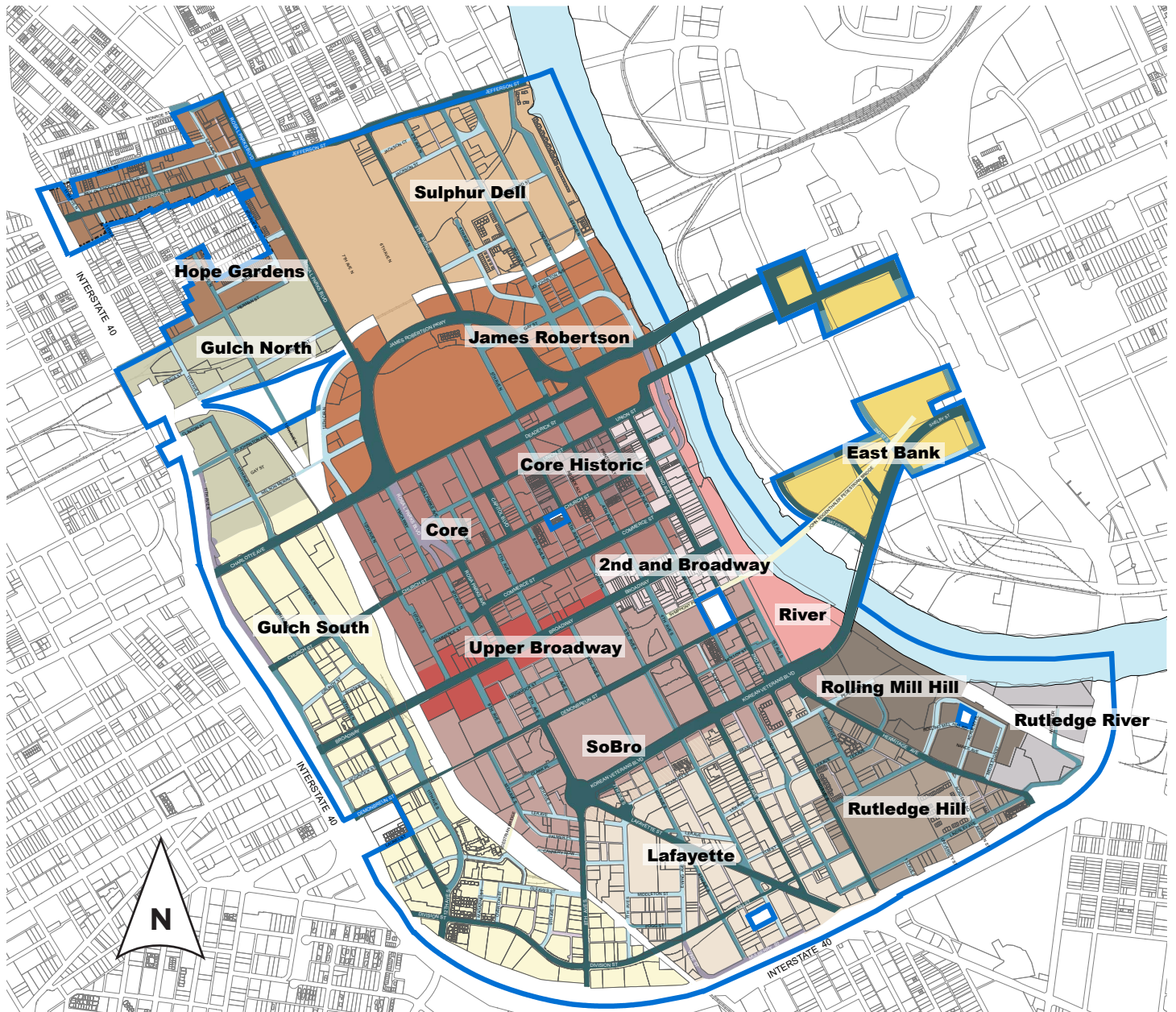







By focusing on the creation of distinctive neighborhoods, pedestrian-oriented development, the DTC reaches toward the goal of an economically healthy, socially vibrant, and sustainable Downtown.

This page left intentionally blank

Section I: Introduction

DTC Regulating Plan: Subdistrict Boundaries



 James Robertson Subdistrict - page 18	 Upper Broadway Subdistrict - page 26	 Lafayette Subdistrict - page 38	 Gulch North Subdistrict - page 46
 Core Subdistrict - page 20	 SoBro Subdistrict - page 34	 Rutledge Hill Subdistrict - page 40	 Hope Gardens Subdistrict - page 50
 Core Historic Subdistrict - page 22	 River Subdistrict - page 32	 Rutledge River Subdistrict - page 44	 Sulphur Dell Subdistrict - page 52
 2nd and Broadway Subdistrict - page 28	 Rolling Mill Hill Subdistrict - page 42	 Gulch South Subdistrict - page 48	 East Bank Subdistrict - page 54
 DTC Boundary			

Section I: Introduction

Application of the DTC

General Provisions

If necessary, to adhere to the laws and regulations of Federal, State, or local departments or agencies, the regulations in this chapter may be modified. Such modifications may be approved by the Planning Commission, the DTC Design Review Committee or Planning Staff, in accordance with the Modifications section of this Chapter.

To the extent that the provisions of the Downtown Code is inconsistent or in conflict with the provisions of the Gateway Urban Design Overlay District that is also zoned DTC, the provisions of the DTC zoning shall be controlling; however, any provisions of the Gateway UDO may be used provided that the standards of the DTC zoning are met.

Applicable Chapters and Sections of the Zoning Code

In addition to the standards set forth within this document, the following Chapters and Sections of the Metro Zoning Code shall apply to properties with DTC zoning.

- All of Chapter 17.04 GENERAL PROVISIONS AND DEFINITIONS
- Within Chapter 17.08 ZONING DISTRICTS AND LAND USE TABLES
 - » Section - 17.08.010 Zoning districts established.
 - » Section - 17.08.020 Zoning districts described.
- All of Chapter 17.16 LAND USE DEVELOPMENT STANDARDS
- Within Chapter 17.20 PARKING, LOADING AND ACCESS
 - » Section - 17.20.040 Adjustments to required parking
 - » Section - 17.20.050 Handicapped parking.
 - » Section - 17.20.060 Parking area design standards.
 - » Section - 17.20.070 Queuing requirements for drive-through facilities.
 - » Section - 17.20.130 Loading space requirements.
- Within Chapter 17.24 LANDSCAPING, BUFFERING AND TREE REPLACEMENT
 - » Section - 17.24.010 Purpose and intent.
 - » Section - 17.24.020 Landscape plan required.
 - » Section - 17.24.030 Standards for form and quality of plants.
 - » Section - 17.24.040 Spacing standards.
- Article II. Tree Protection and Replacement
 - » Section - 17.24.090 Removal of protected trees.
 - » Section - 17.24.100 Replacement of trees.
 - » Section - 17.24.110 Protection of trees during development activities.
 - » Section - 17.24.120 Less desirable trees.
 - » Section - 17.24.160 Interior planting requirements.
 - » Section - 17.24.170 Nonconforming parking areas.
- All of Chapter 17.28 ENVIRONMENTAL AND OPERATIONAL PERFORMANCE STANDARDS
- All of Chapter 17.32 SIGN REGULATIONS
- All of Chapter 17.36 OVERLAY DISTRICTS, except Article XII, Urban Zoning Overlay (UZO) District.
- All of Chapter 17.40 ADMINISTRATION AND PROCEDURES, except as otherwise provided for within this document.

Section I: Introduction

Application of the DTC: How to Use this Document

How to Use this Document

The Downtown Code is organized by Subdistricts and Street Types, as identified on the Regulating Plan.

To determine the standards which apply to a particular property:

- On the Regulating Plan, identify the Subdistrict in which the property is located and on what type of street(s) it fronts.
- Consult the Building Regulations for development standards relevant to the Subdistrict.
- Consult the Use Table for uses allowed in each Area.
- Consult the General Standards section for guidance on development standards for all Subdistricts.

Subdistricts and Areas

- Downtown Nashville consists of numerous neighborhoods with unique character. The development standards for the DTC are organized by Subdistricts, which establish the zoning of each neighborhood to create or maintain the envisioned character.
- The DTC is divided into 5 Areas (North, South, West, East and Central), which establish the allowed uses.
- The DTC includes General Standards that apply to all Subdistricts.

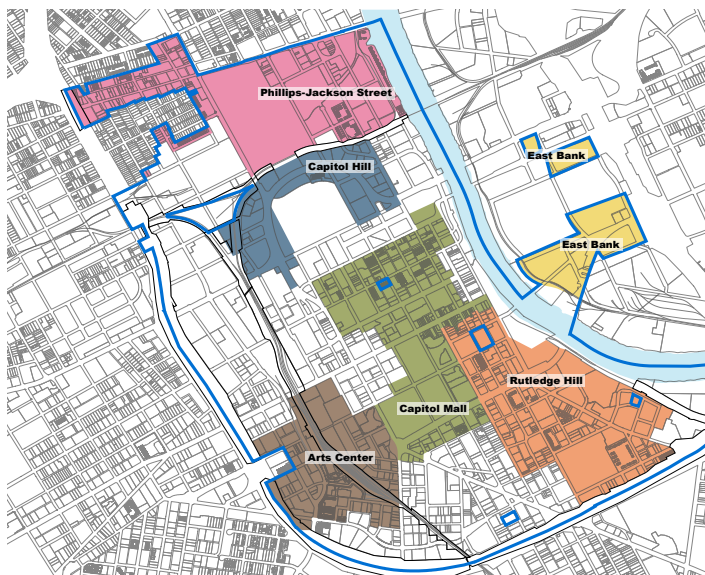

MDHA redevelopment districts.

Regulating Plan

- The Regulating Plan is the official zoning map of the DTC. The Subdistrict boundaries are shown on the series of maps which comprise the Regulating Plan.
- Subdistrict boundaries extend to the centerline of all abutting public street right-of-ways. Any properties not within the subdistrict boundaries of the regulating plan including, but not limited to, rail and river corridors shall be considered an open space subdistrict.
- Unless otherwise regulated by the DTC subdistrict standards, property that is within more than one subdistrict may apply for a minor modification to use the standards of either subdistrict. If the Executive Director of the Planning Department finds that additional consideration is warranted, then the modification request may be submitted to the Downtown Code/MDHA Design Review Committee as a major modification.

Overlapping Plans

Within the area governed by the DTC, there exist other regulations and design guidelines intended to work in conjunction with the DTC. The DTC does not exempt development from complying with the regulations of other Federal, State, and Local departments and agencies. These departments and agencies should be contacted during the development process to address their rules, regulations and policies.

Section I: Introduction

Application of the DTC: Modifications

Modifications to the Standards

Based on site-specific issues, an applicant may seek modifications to the standards of this document.

Any standard within the DTC may be modified, insofar as the intent of the standard is being met, the modification results in better urban design for the neighborhood as a whole, and the modification does not impede or burden existing or future development of adjacent properties.

The DTC, the Downtown Plan and any other policies and regulations from governing agencies shall be consulted when considering modifications. Any standards that shall not be modified are explicitly noted in this document.

Modifications may be approved by Planning staff, the Downtown Code Design Review Committee (DTC DRC) or the Planning Commission.

- Minor modifications – deviations of 20 percent or less – or modifications explicitly noted herein as minor may be approved by Planning Staff.
- Any determination made by the Planning Staff may be appealed to the DTC DRC.
- Major modifications – deviations of more than 20 percent – and modifications of standards without numbers may be approved by the DTC DRC. Within MDHA redevelopment districts, the MDHA DRC shall act as the DTC DRC.
- Any determination made by the DTC DRC or the MDHA DRC regarding standards of the DTC may be appealed to the Planning Commission by the applicant or the Planning Department.
- All building permits for modifications authorized by the Planning Staff, DTC DRC, or Planning Commission must be obtained within **three** years from the date of approval.

Variances and Special Exceptions

Variances and special exceptions that are not specifically for standards of the DTC zoning district shall follow the procedures of Chapter 17.40, Articles VII and VIII of the zoning code. Standards specific to the DTC zoning district may be modified based on the modifications section of this document.

Overall Height Modifications

Prior to reviewing requests for modifications to overall height, the Executive Director of the Planning Department shall determine whether the development **proposal** has **exhausted** efforts to use all appropriate bonuses available in the Bonus Height Program. The Executive Director's decision may be appealed to the DTC DRC/MDHA DRC. If it has been determined that all efforts have been **exhausted** to use the Bonus Height Program, the applicant shall hold a community meeting providing notices to property owners within 300 feet, and the Planning Commission shall review the modification request and may grant, at its discretion, additional height for exceptional design, including but not limited to unique architecture, exceptionally strong streetscape, contribution to the skyline, improvement of the project's relationship to surrounding properties, and improvement to the character of the neighborhood. In some instances, consideration may be given where a project results in implementation of significant community improvements (e.g. quality open space, upgrading public infrastructure, or others determined by the policies of Metro departments) and/or contributes to the implementation of community improvements determined by the policies of Metro departments.

Application Process

The DTC DRC shall review and approve a DTC Concept Plan for a site prior to approval of a DTC Final Site Plan. A recommendation from the Nashville Department of Transportation and Multimodal Infrastructure shall be required for a DTC Concept Plan.

- The DTC, the Downtown Plan, other policies, **official guidelines (such as the Downtown Code Design Guidelines)**, regulations from governing agencies, and other best practices shall be consulted when considering a DTC Concept Plan. **No standard within the DTC shall relieve a project of the review process associated with a Concept Plan application.**
- Modifications shall be requested concurrently with the DTC Concept Plan.
- Within MDHA redevelopment districts, the MDHA DRC shall act as the DTC DRC and final MDHA approval shall act as the DTC Concept Plan.
- Any determination made by the Planning Staff may be appealed to the DTC DRC. Any determination made by the DTC DRC or the MDHA DRC regarding standards of the DTC may be appealed to the Planning Commission by the applicant or the Planning Department.

Section I: Introduction

Application of the DTC: Design Review and Compliance

Design Review Committee

The DTC DRC is subject to the rules and procedures adopted by the Planning Commission. The DTC DRC will consist of eight (8) voting members.

One member shall be nominated by each of the following with confirmation by the Planning Commission:

- Chamber of Commerce
- Civic Design Center
- Downtown Partnership
- Urban Residents Association

One member shall be appointed by the following:

- Mayor
- Vice-Mayor, on behalf of the Metro Council
- Historic Commission
- Planning Commission

Each member shall be a design professional, with a degree or several years of experience in architecture, landscape architecture, planning or urban design. The members nominated by the Nashville Area Chamber of Commerce and the Nashville Downtown Partnership shall be exempt from this requirement.

Each term shall be four years, with the appointees of the Mayor, Vice-Mayor and Planning Commission serving an initial two-year term upon adoption of the DTC. Any vacancy occurring during the unexpired term of any members shall be filled in the manner prescribed herein for the original selection of the members of the DTC DRC. A new mayor and/or new vice mayor may appoint a new representative after the term of the existing representative has expired.

Compliance with the DTC shall be required according to the following:

- Level 1: An addition of twenty-five percent or less of the square footage of the existing building
 - » Shall not increase the degree of nonconformity.
- Level 2: An addition of more than twenty-five percent of the square footage of the existing building or 1000 square feet, whichever is greater
 - » Improvements to the sidewalk corridor according to the *Major and Collector Street Plan*.

- » Where possible, the addition of street trees
- » Parking lot landscaping standards
- » Shall not increase the degree of nonconformity.
- Level 3: Redevelopment after the demolition or destruction of more than five percent and less than fifty percent of the existing building
 - » Improvements to the sidewalk corridor according to the *Major and Collector Street Plan*.
 - » Where possible, the addition of street trees
 - » Parking lot landscaping standards
 - » To the extent practicable, new construction shall be in compliance with applicable standards of the DTC.
- Level 4: Redevelopment after the demolition or destruction of more than fifty percent of the existing building
 - » All standards of the DTC
 - » Improvements to the sidewalk corridor according to the *Major and Collector Street Plan*.
- Level 5: New construction of buildings, parking, open space, etc
 - » All standards of the DTC
 - » Improvements to the sidewalk corridor according to the *Major and Collector Street Plan*.

Signage Compliance

- For those properties within Historic Zoning Overlays, the sign standards of the CF zoning district shall apply, along with historic zoning district design guidelines.
- For those properties not within Historic Zoning Overlays, the sign standards of the DTC zoning district shall apply.
- No new billboards are allowed within the DTC boundaries.

This page left intentionally blank

Section II: Subdistrict Standards

Section II: Subdistrict Standards

James Robertson Subdistrict: Regulating Plan



The James Robertson Subdistrict is the primarily civic area surrounding Capitol Hill. The Downtown Plan emphasizes “preserving the James Robertson neighborhood’s treasured civic and open space resources, while encouraging redevelopment to offer a mixture of uses...while recognizing that the area’s uses will continue to be dominated by government activities.” The importance of the State Capitol as a Nashville and Tennessee landmark also warrants maintaining views of the Capitol from all vantage points to the west, north and east. The DTC allows a maximum height of 560’ above sea level (the elevation of the base of the capitol building) to preserve these views.

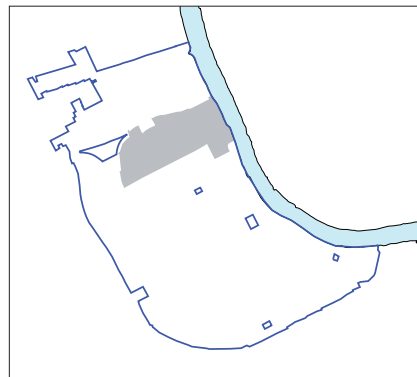

Legend

- James Robertson Subdistrict
- Primary Street
- Secondary Street
- Tertiary Street
- Other Street
- Alley

Section II: Subdistrict Standards

James Robertson Subdistrict: Building Regulations

FRONTAGE

A Allowed Frontage Types with Required Build-to Zone

Primary Street

- Storefront Frontage
 - » James Robertson Boulevard
 - West of 3rd Ave 20'-30'
 - East of 3rd Ave 0'-10'
 - » Charlotte Avenue 0'-10'
- Stoop Frontage
 - » James Robertson Boulevard
 - West of 3rd Ave 20'-30'
 - East of 3rd Ave 5'-10'
 - » Charlotte Avenue 5'-10'

Secondary Street

- Storefront Frontage 0'-10'
- Stoop Frontage 5'-10'

Tertiary Street

- Storefront Frontage 0'-10'
- Stoop Frontage 5'-10'

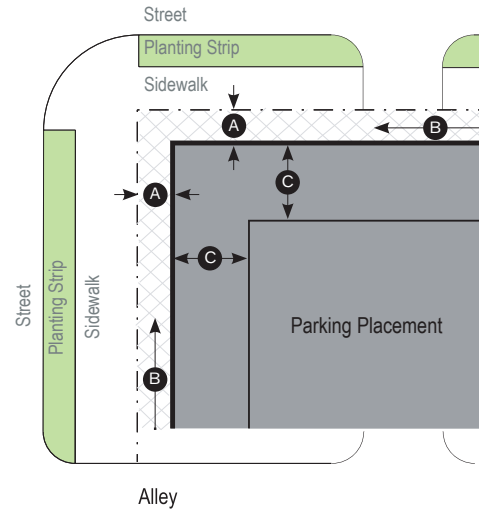

Building Plan

B Facade Width

Primary Street	80% of lot frontage min.
Secondary Street	80% of lot frontage min.
Tertiary Street	60% of lot frontage min.

Remaining lot frontage may be used for pedestrian amenities and shall not be used for parking.

C Min. Building Depth 15' from building facade

A building liner is required surrounding parking structures on the all floors facing James Robertson Blvd.

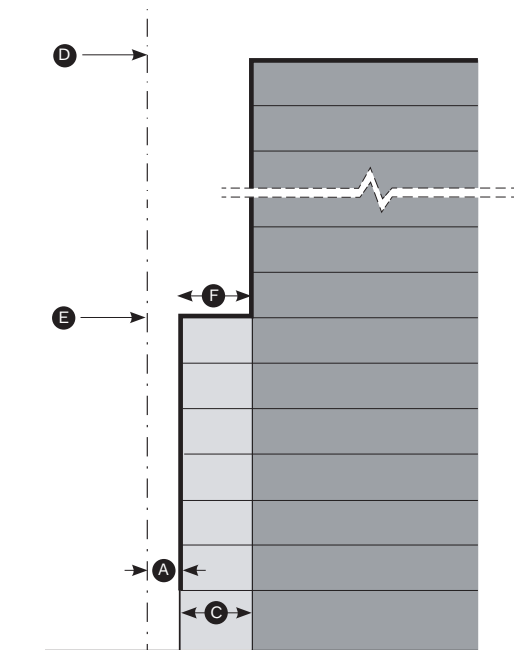

Building Section

HEIGHT

D Max. elevation of 560'

Step-back*

Step-back required for all buildings 8 stories or greater on all public streets and Open Space

E Step-back between 4th and 8th stories

F Min. step-back depth 15'

*see page 64 for full description

SIDEWALK & PLANTING

Improvements to the sidewalk corridor according to the General Standards and the Major and Collector Street Plan.

NOTES

Uses: page 61; General Standards: page 63

Section II: Subdistrict Standards

Core Subdistrict: Regulating Plan



The Core is the heart of the Downtown business district, the economic engine of the Middle Tennessee region, and a significant economic force in the Southeast. It is the densest neighborhood in Downtown and has the greatest height allowances. Pedestrian comfort and safety should be prioritized with an interesting sidewalk realm, activity on the ground level of buildings, and controlled vehicular access.

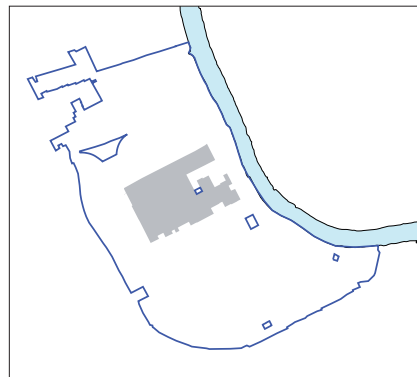

Legend	
	Core Subdistrict
	Primary Street
	Secondary Street
	Tertiary Street
	Other Street
	Alley

Section II: Subdistrict Standards

Core Subdistrict: Building Regulations

FRONTAGE

A Allowed Frontage Types with Required Build-to Zone

Primary Street

- Storefront Frontage 0'-10'
- Stoop Frontage 5'-10'

Secondary Street

- Storefront Frontage 0'-10'
- Stoop Frontage 5'-10'

Tertiary Street

- Storefront Frontage 0'-10'
- Stoop Frontage 5'-10'

B Facade Width

Primary Street 80% of lot frontage min.

Secondary Street 80% of lot frontage min.

Tertiary Street 60% of lot frontage min.

Remaining lot frontage may be used for pedestrian amenities and shall not be used for parking.

C Min. Building Depth

15' from building facade

HEIGHT

D Max.

30 stories

Additional height available through the Bonus Height Program

SIDEWALK & PLANTING

Improvements to the sidewalk corridor according to the General Standards and the Major and Collector Street Plan.

NOTES

Uses: page 61; General Standards: page 63

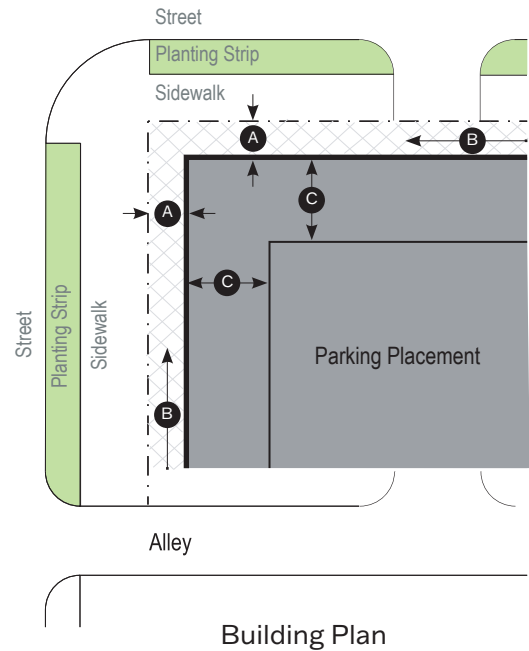

Building Plan

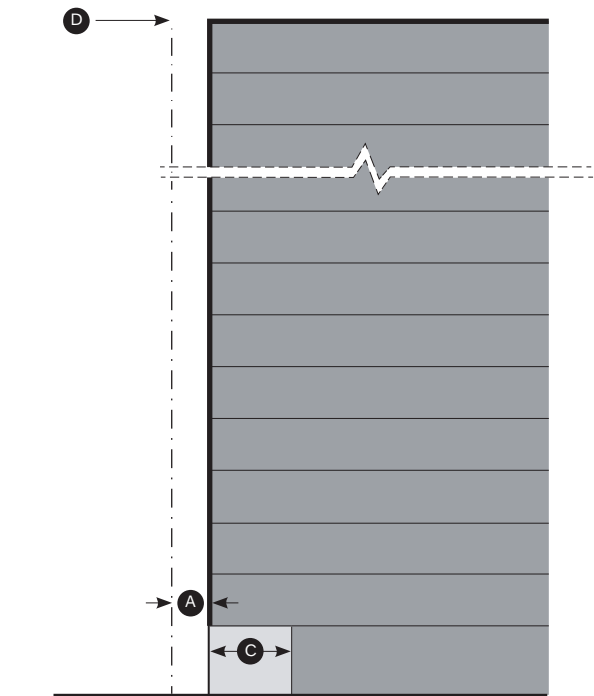

Building Section

Section II: Subdistrict Standards

Core Historic Subdistrict: Regulating Plan

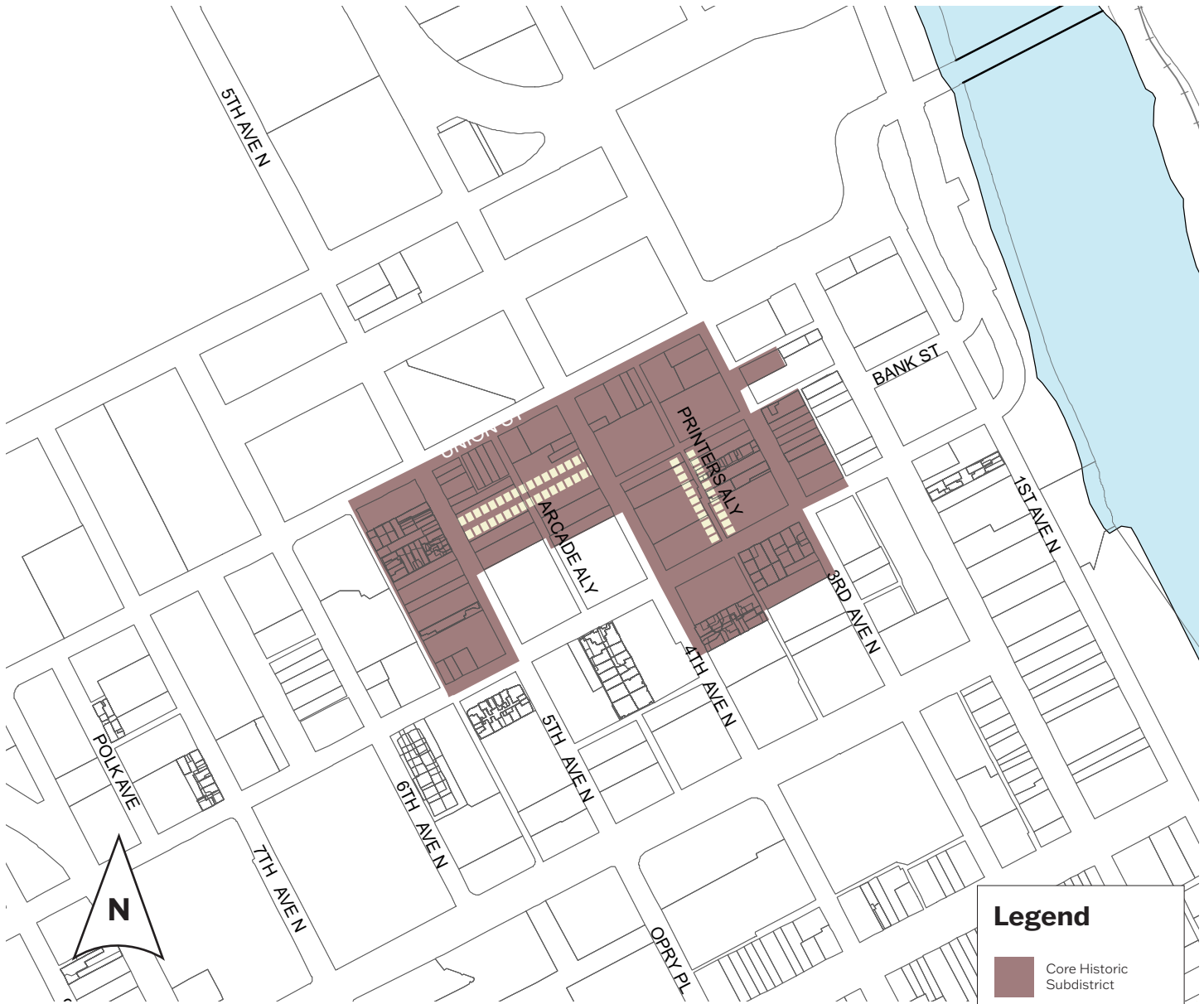

The Core Historic neighborhood has two historic urban spaces – the Arcade and Printers' Alley. This neighborhood is comprised several historic buildings, many of which have been recently renovated. The height maximums for this subdistrict reflect historic urban design features – lower buildings mid-block and taller buildings to “book-end” the blocks at the corners. The adaptive reuse of historic buildings is encouraged and new construction should be of appropriate scale and detailing, maintaining the existing storefront rhythm. Pedestrian comfort and safety should be prioritized with an interesting sidewalk realm, activity on the ground level of buildings, and controlled vehicular access.

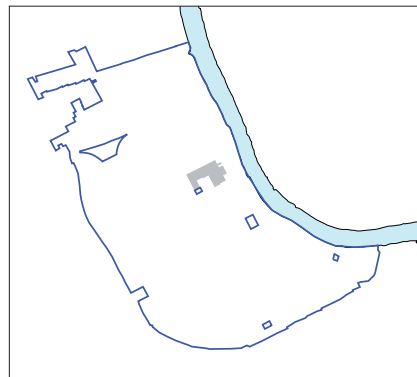

Section II: Subdistrict Standards

Core Historic Subdistrict: Building Regulations

FRONTAGE

- A Allowed Frontage Types with Required Build-to Zone**
- Primary Street
- Storefront Frontage 0'
 - Stoop Frontage 5'-10'
- Secondary Street
- Storefront Frontage 0'
 - Stoop Frontage 5'-10'
- B Facade Width**
- Primary Street 95% of lot frontage min.
- Secondary Street 95% of lot frontage min.
- C Min. Building Depth** 15' from building facade
- A building liner is required surrounding parking structures on all floors facing public streets and Open Space.

SIDEWALK & PLANTING

Improvements to the sidewalk corridor according to the General Standards and the Major and Collector Street Plan.

NOTES

Uses: page 61; General Standards: page 63

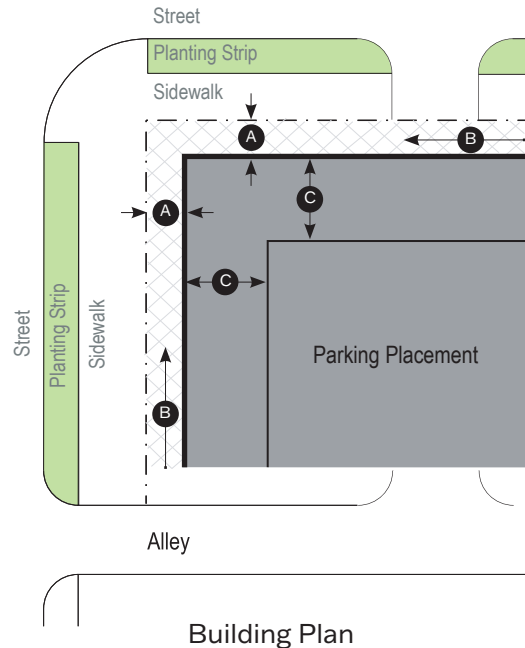

Section II: Subdistrict Standards

Core Historic Subdistrict: Building Regulations

HEIGHT

D Max.		
On Corners	10 stories	
Mid-Block	6 stories	
Step-back		
Step-back after		
E	• On Printer's Alley	4 stories
F	• All Others	6 stories
Depth		
G	• On Printer's Alley	10' min.
H	• All Others	10' min. and max.
Step-back not required for buildings fronting Church Street.		
Buildings 6 stories or less shall not step-back and all stories shall occupy the Build-to Zone.		
I Max. Tower Dimensions	90' x 90'	

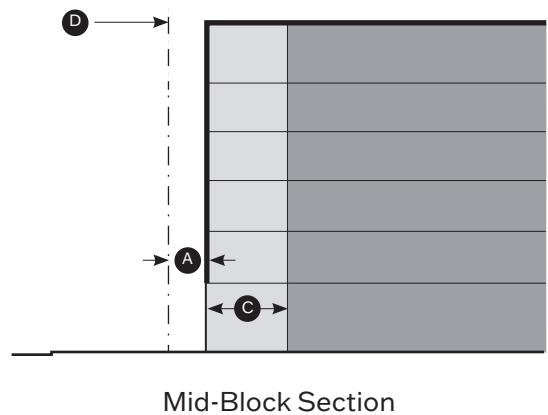
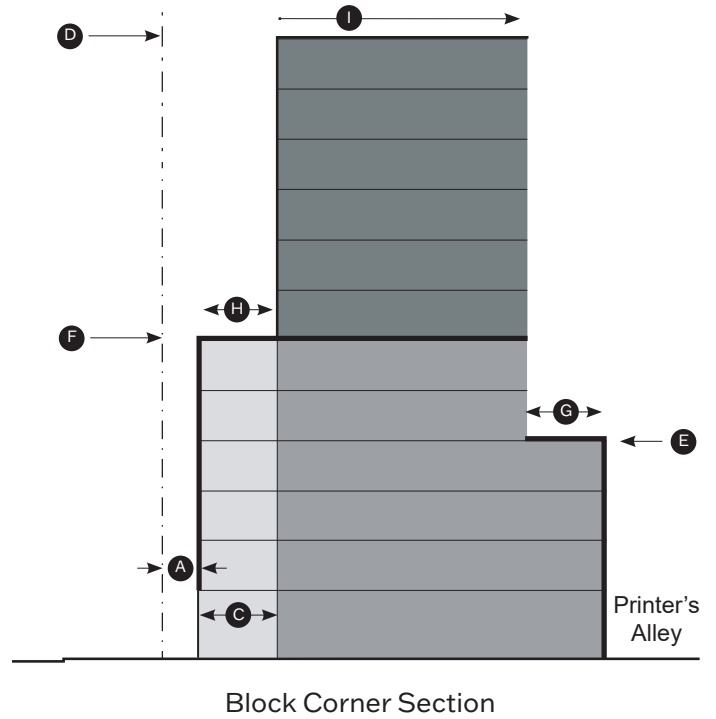

Section II: Subdistrict Standards

Core Historic Subdistrict: Building Design and Facade Articulation

BUILDING DESIGN AND FACADE ARTICULATION

- L Primary building divisions** 20'-50' wide
 - M Secondary building divisions** 5'-25' wide
Secondary building divisions are defined by solid vertical elements that consist of changes in materials or planes within the facade.
 - N First Floor height** 16' min.
- Windows**
- O Ground floor - 60% glazing required from 2 feet above grade to the finished floor of the 2nd story**
 - P Window sill height** 18"-24"
 - Q Upper Floors - Windows shall be vertically oriented at a ratio of 2:1 or greater.**

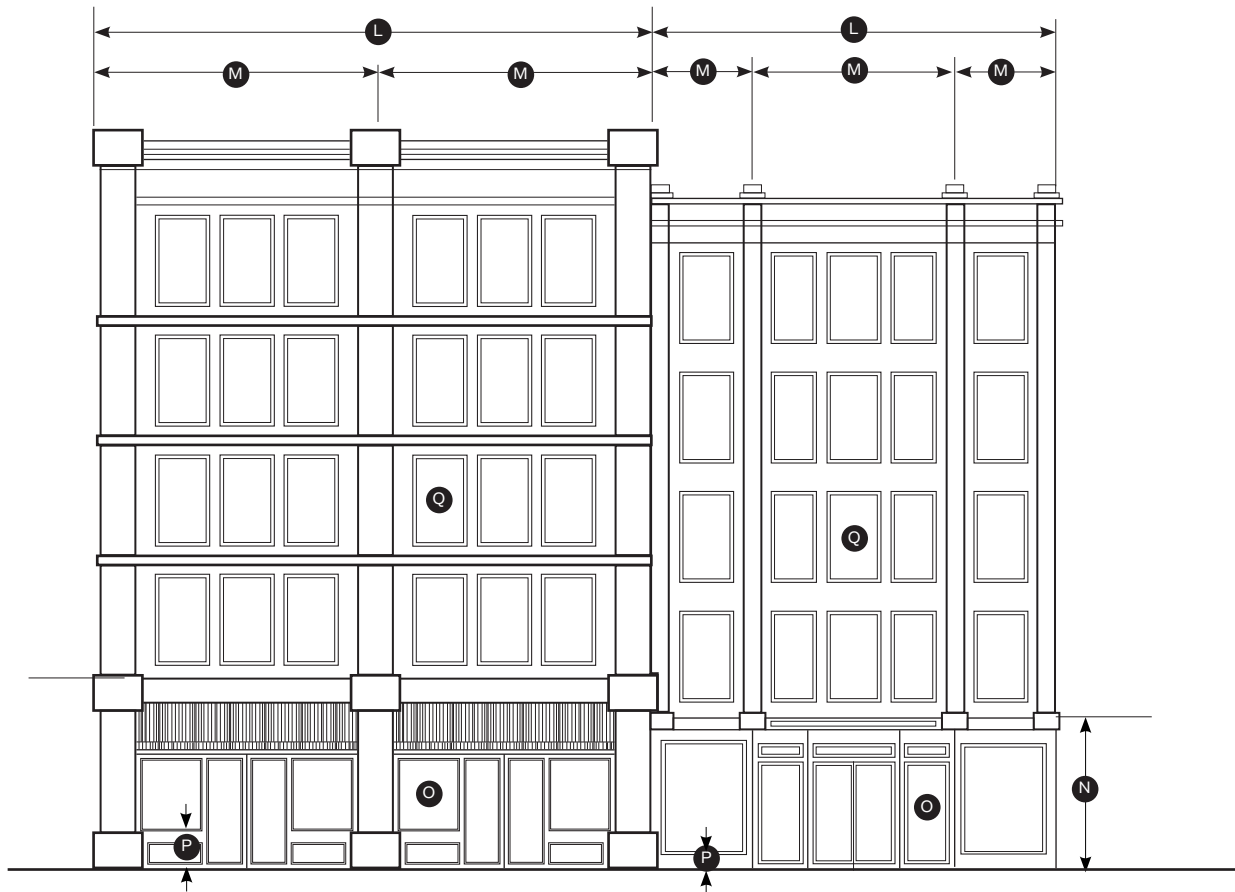

Section II: Subdistrict Standards

Upper Broadway Subdistrict: Regulating Plan



The Upper Broadway area is one of the most important gateways into Downtown. Several civic and cultural buildings front this urban corridor. Maintenance and adaptive reuse of historic buildings is encouraged, and the height and scale of new buildings should be in-keeping with the existing urban pattern. When properties front more than one street, Broadway should be the Principal frontage.

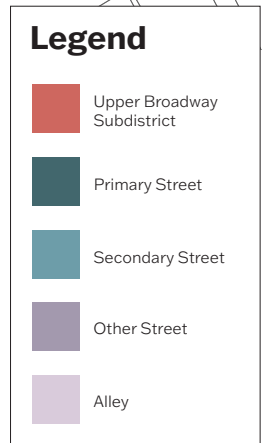
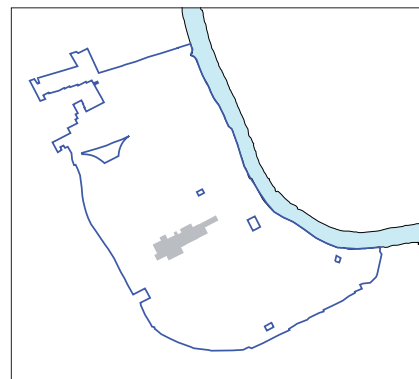

Section II: Subdistrict Standards

Upper Broadway Subdistrict: Building Regulations

FRONTAGE

A Allowed Frontage Types with Required Build-to Zone

Primary Street

- Storefront Frontage 0-5'

Secondary Street

- Storefront Frontage 0'-5'

**Civic Frontages are encouraged in this subdistrict.

B Facade Width

Primary Street 80% of lot frontage min.

Secondary Street 80% of lot frontage min.

Remaining lot frontage may be used for pedestrian amenities and shall not be used for parking.

C Min. Building Depth 15' from building facade

A building liner is required surrounding parking structures on all floors facing Broadway and Open Space.

HEIGHT

D Max. 100'

SIDEWALK & PLANTING

Improvements to the sidewalk corridor according to the General Standards and the Major and Collector Street Plan.

NOTES

Uses: page 61; General Standards: page 63

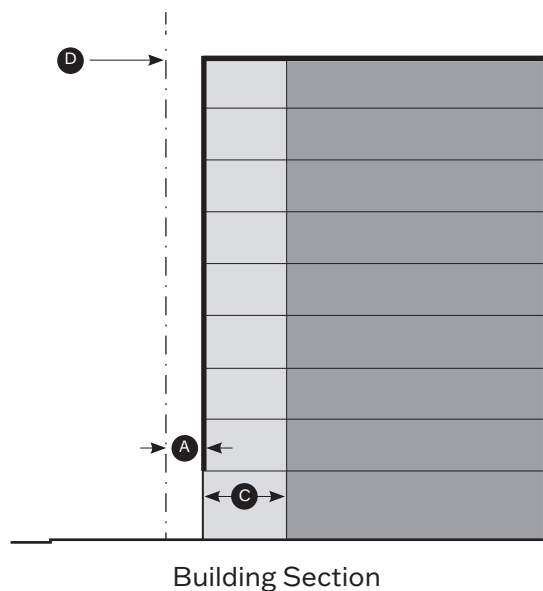
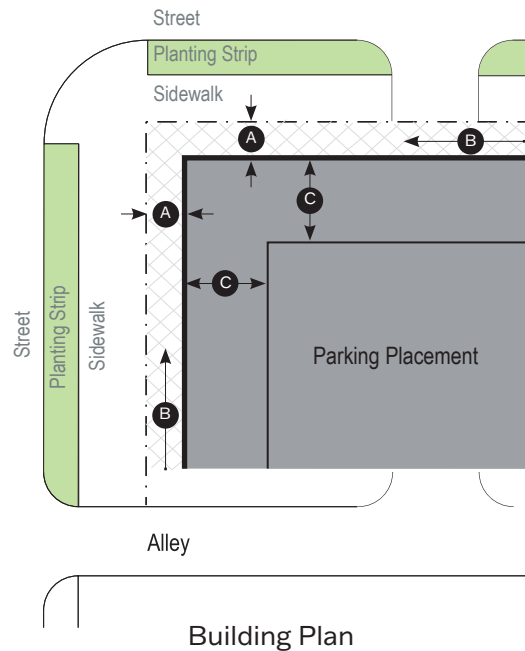

Section II: Subdistrict Standards

2nd and Broadway Subdistrict: Regulating Plan



Second and Broadway is the heart of Downtown; where the main street of the city meets the Cumberland River. The Downtown Plan encourages maintaining “the low-scale, pedestrian-friendly historic character” and adaptively reusing existing historic structures “in order to respect, maintain, and enhance not only individual structures, but the existing character of the Second and Broadway neighborhood as a whole.” With the exception of the Stahlman building on the northeast corner of 3rd and Union, this neighborhood is overseen by two historic zoning overlays: The Second Avenue Historic Zoning Overlay and The Broadway Historic Zoning Overlay. Property owners must contact the Metro Historic Commission for additional details.

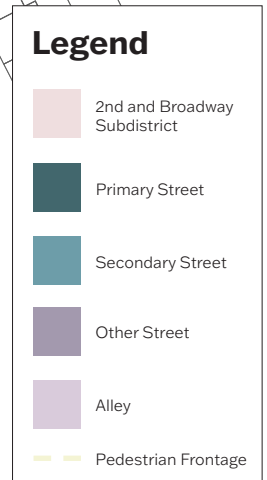
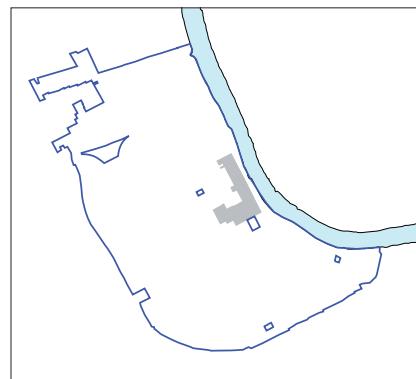

Section II: Subdistrict Standards

2nd and Broadway Subdistrict: Building Regulations

FRONTAGE

A	Allowed Frontage Types with Required Build-to Zone	
	Primary Street	
	• Storefront Frontage	0'
	Secondary Street	
	• Storefront Frontage	0'
B	Facade Width	
	Primary Street	100% of lot frontage min.
	Secondary Street	100% of lot frontage min.
C	Min. Building Depth	15' from building facade

HEIGHT

D	Min.	40'
E	Max. at the Street	
	• On Broadway	5 stories to a max. height of 65'
	• On 2nd Ave	8 stories to a max. height of 105'
	• On Union St	12 stories to a max. height of 180'
	• All other streets	8 Stories to a max. height of 105'
F	Min. Step-Back Depth	
	• On Broadway	30'
	• On all other streets	20'
G	Max. Height	1 additional story
	• Within 150' of the right-of-way of Broadway, height shall not exceed 6 stories or 80'	
	• Between 150' and 200' of the right-of-way of Broadway, height shall not exceed 7 stories or 90'.	

SIDEWALK & PLANTING

Improvements to the sidewalk corridor according to the General Standards and the Major and Collector Street Plan.

NOTES

Uses: page 61; General Standards: page 63

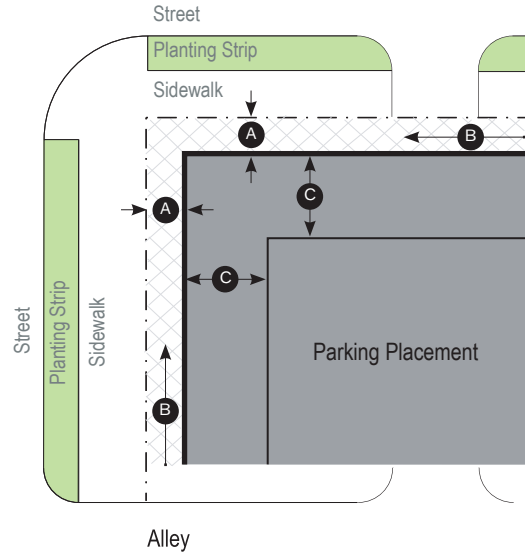

Building Plan

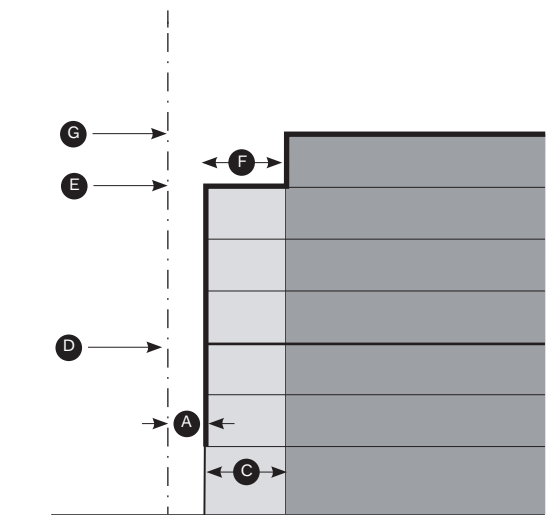

Building Section

Section II: Subdistrict Standards

2nd and Broadway Subdistrict: Building Design and Facade Articulation

BUILDING DESIGN AND FACADE ARTICULATION

- L Primary Building Divisions** 20'-50' wide
- M Secondary Building Divisions** 5'-25' wide
Secondary building divisions are defined by solid vertical elements that consist of changes in materials or planes within the facade.
- N First Floor Height** 16' min.

Windows

- O Ground floor - 60% glazing required from 2 feet above grade to the finished floor of the 2nd story**
- P Window sill height** 18"-24"
- Q Upper Floors - Windows shall be vertically oriented at a ratio of 2:1 or greater.**



This page left intentionally blank

Section II: Subdistrict Standards

River Subdistrict: Regulating Plan



The River subdistrict is a unique area between 1st Avenue South and the Cumberland River. This area is owned by the city and is envisioned to be an amenity for all residents and visitors. New development should be done in conjunction with the Parks Department's *Riverfront Redevelopment Plan* and should treat the river as an amenity while keeping a strong urban edge along 1st Avenue South and the boulevard. The maximum height is low in order to maintain views of the river from many vantage points in Downtown.

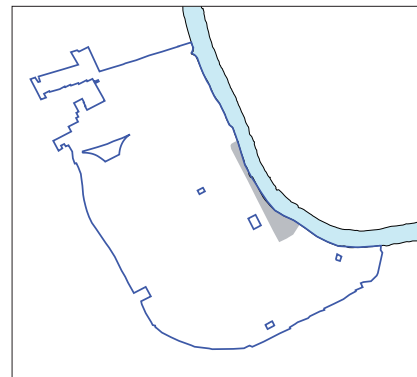

Legend

- River Subdistrict
- Primary Street
- Secondary Street
- Tertiary Street
- Other Street
- Alley
- Pedestrian Frontage

Section II: Subdistrict Standards

River Subdistrict: Building Regulations

FRONTAGE

A Allowed Frontage Types with Required Build-to Zone

Primary Street

- Storefront Frontage 0'-10'
- Stoop Frontage 5'-10'

Secondary Street

- Storefront Frontage 0'-10'
- Stoop Frontage 5'-10'

Tertiary Street

- Storefront Frontage 0'-10'
- Stoop Frontage 5'-15'

B Facade Width

Primary Street	80% of lot frontage min.
Secondary Street	80% of lot frontage min.
1st Avenue	70% of lot frontage min.
Tertiary Street	60% of lot frontage min.

Remaining lot frontage may be used for pedestrian amenities and shall not be used for parking.

C Min. building depth 15' from building facade

HEIGHT

D Max. 10 stories

Step-back*

Step-back required for buildings 8 stories or greater on 1st Avenue frontage

- E Step-back between 4th and 8th stories
- F Min. step-back depth 15'

*see page 64 for full description

SIDEWALK & PLANTING

Improvements to the sidewalk corridor according to the General Standards and the Major and Collector Street Plan.

NOTES

Uses: page 61; General Standards: page 63

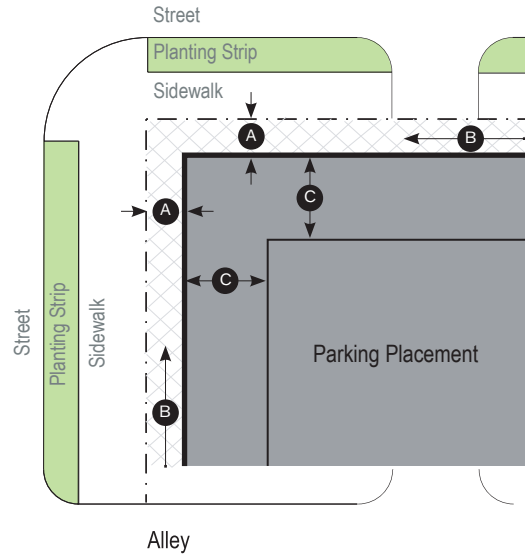

Building Plan

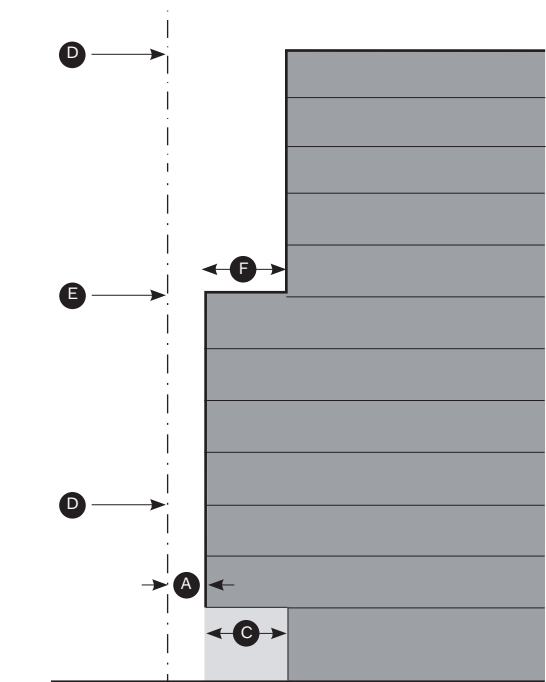

Building Section

Section II: Subdistrict Standards

SoBro Subdistrict: Regulating Plan



The SoBro neighborhood is intended to be a high-intensity, mixed-use neighborhood emphasizing cultural and entertainment uses with a mix of residential and office uses. SoBro is an extension of the Core in height and intensity, but it is also a transition to the lower, mid-rise Lafayette neighborhood.

Properties with frontage on the boulevard, and Transitional Properties that consolidate to have frontage on the boulevard, shall be part of the SoBro Subdistrict. Properties south of the boulevard – Transitional Properties – without frontage on the boulevard, shall be part of the Lafayette Subdistrict.

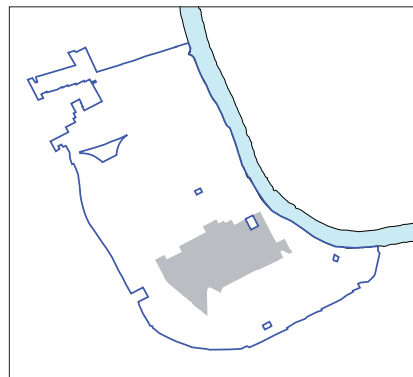

Legend	
	SoBro Subdistrict
	Frontage Condition
	Transitional Properties
	Primary Street
	Secondary Street
	Tertiary Street
	Other Street
	Alley
	Pedestrian Frontage

Section II: Subdistrict Standards

SoBro Subdistrict: Building Regulations

FRONTAGE

A	Allowed Frontage Types with Required Build-to Zone	
	Primary Street	
	• Storefront Frontage	0'-10'
	• Stoop Frontage	5'-10'
	Secondary Street	
	• Storefront Frontage	0'-10'
	• Stoop Frontage	5'-10'
	Tertiary Street	
	• Storefront Frontage	0'-10'
	• Stoop Frontage	5'-15'
B	Facade Width	
	Primary Street	80% of lot frontage min.
	Secondary Street	80% of lot frontage min.
	Tertiary Street	60% of lot frontage min.
	Remaining lot frontage may be used for pedestrian amenities and shall not be used for parking.	
C	Min. Building Depth	15' from building facade

HEIGHT

D	Min.	
	• On Korean Veterans Blvd & the roundabout	3 stories or 35'
E	Max.	
	• West side of 1st Ave frontage and east side of 2nd Ave frontage	unless fronting KVB 15 stories
	• 8th Avenue frontage, south of the roundabout	8 stories within 100' of 8th Ave; 30 stories beyond 100' of 8th Ave stories
	• Subdistrict general	30 stories
	Additional height available through the Bonus Height Program	
	Step-back*	
F	Step-back between	
	• Buildings taller than 7 stories	4th and 8th stories
G	Min. step-back depth	15'
	*see page 64 for full description	

SIDEWALK & PLANTING

Improvements to the sidewalk corridor according to the General Standards and the Major and Collector Street Plan.

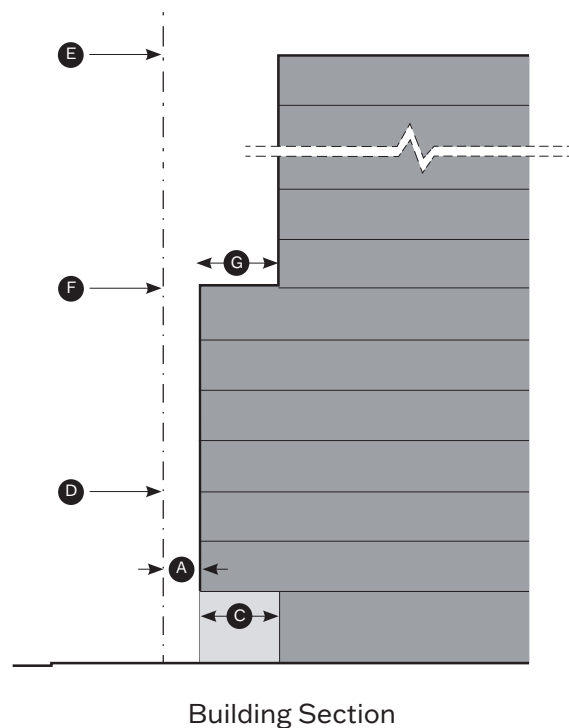
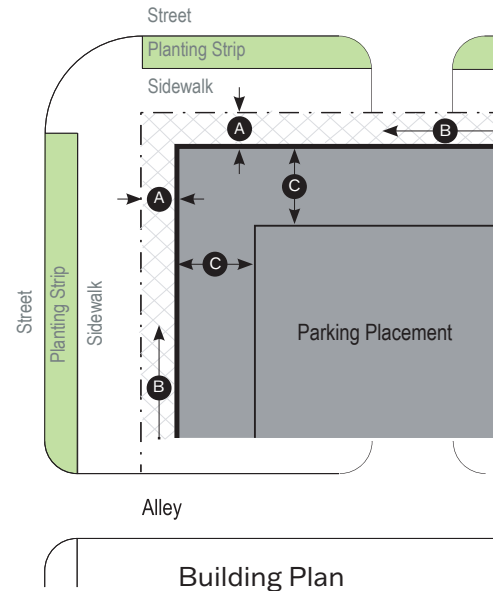

NOTES

All standards of the Gateway UDO shall apply to development along the boulevard except maximum height at the street, step-back depth, overall height, and floor area ratio. The review process for the DTC and the UDO will be consolidated.

Uses: page 61; General Standards: page 63

Section II: Subdistrict Standards

SoBro Subdistrict: Regulating Plan







Buildings fronting the future roundabout shall respond to the circle with a facade perpendicular to the radius of the roundabout or a curved facade concentric with the roundabout.

Curvilinear architectural elements such as arcades are encouraged.

Only Storefront Frontage shall be permitted fronting the roundabout.

Legend

	Primary Street
	Secondary Street
	tertiary Street
	Other Street
	Alley

This page left intentionally blank

Section II: Subdistrict Standards

Lafayette Subdistrict: Regulating Plan



The Lafayette neighborhood is currently a primarily industrial and business services environment with strong transportation connections to the Gulch, SoBro, Midtown, and South Nashville neighborhoods. This neighborhood will likely retain many of the industrial and business service uses while accommodating a greater variety of uses. The neighborhood is primarily low-rise and should act as a transition from the height of the Core and SoBro to the single-family neighborhoods to the South.

Transitional properties that consolidate to have frontage on the boulevard shall be part of the SoBro Subdistrict. Transitional properties that do not consolidate to have frontage on the boulevard shall be part of the Lafayette Subdistrict.

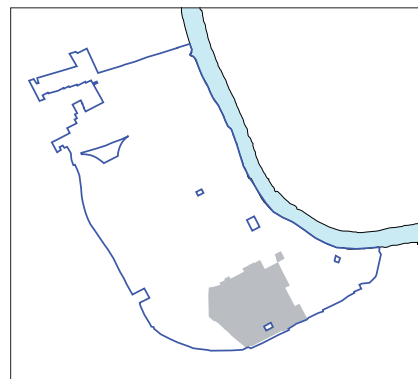

Legend	
	Lafayette Subdistrict
	Transitional Properties
	Primary Street
	Secondary Street
	Tertiary Street
	Other Street
	Alley

Section II: Subdistrict Standards

Lafayette Subdistrict: Building Regulations

FRONTAGE

A Allowed Frontage Types with Required Build-to Zone

Primary Street

- Storefront Frontage 0'-10'
- Stoop Frontage 5'-10'

Secondary Street

- Storefront Frontage 0'-10'
- Stoop Frontage 5'-10'
- Porch Frontage 10'-15'

Tertiary Street

- Storefront Frontage 0'-10'
- Stoop Frontage 5'-10'
- Porch Frontage 10'-15'

Industrial Frontage is allowed in this Subdistrict.

B Facade width

- Primary Street 80% of lot frontage min.
- Secondary Street 80% of lot frontage min.
- Tertiary Street 60% of lot frontage min.

Remaining lot frontage may be used for pedestrian amenities and shall not be used for parking.

C Min. building depth 15' from building facade

HEIGHT

D Min.

- On the roundabout 3 stories or 35'

E Max.

- Transitional Properties 15 stories
- On Lafayette St 12 stories
- Subdistrict general 8 stories

Additional height available through the Bonus Height Program

Step-back *

Step-back required for all buildings 7 stories or greater fronting public streets

- F Step-back between 4th and 7th stories
- G Min. step-back depth 15'

*see page 64 for full description

SIDEWALK & PLANTING

Improvements to the sidewalk corridor according to the General Standards and the Major and Collector Street Plan.

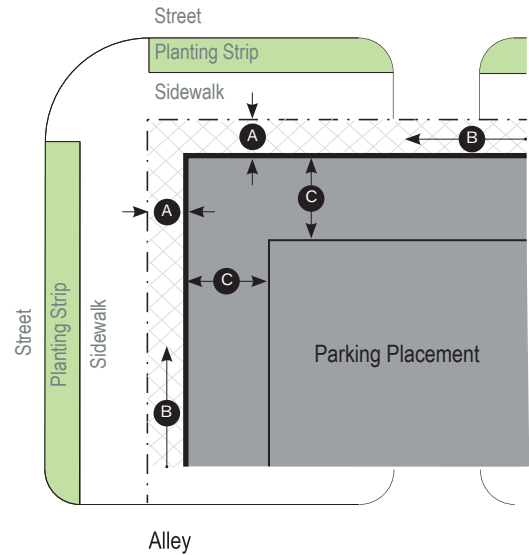

Building Plan

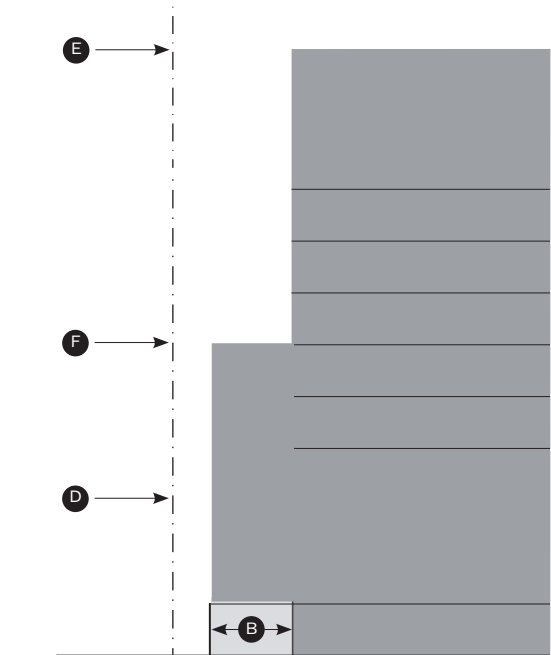

Building Section

NOTES

Uses: page 61; General Standards: page 63

Section II: Subdistrict Standards

Rutledge Hill Subdistrict: Regulating Plan



The Rutledge Hill neighborhood includes a variety residential and civic historic buildings. This area is largely intact and new buildings of complimentary height, scale and massing.

Some of these properties are governed by a National Register District that regulates development, restoration and demolition. Property owners must contact the Metro Historic Commission for additional details.

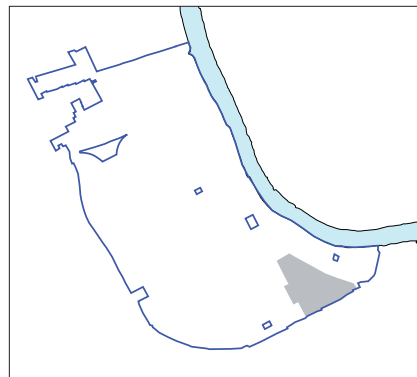

Section II: Subdistrict Standards

Rutledge Hill Subdistrict: Building Regulations

FRONTAGE

A Allowed Frontage Types with Required Build-to Zone

Primary Street

- Storefront Frontage 0'-10'
- Stoop Frontage 5'-10'

Secondary Street

- Storefront Frontage 0'-10'
- Stoop Frontage 5'-10'
- Porch Frontage 10'-15'

Tertiary Street

- Storefront Frontage 0'-10'
- Stoop Frontage 5'-10'
- Porch Frontage 10'-15'

B Facade width

Primary Street 80% of lot frontage min.

Secondary Street 60% of lot frontage min.

Tertiary Street 60% of lot frontage min.

Remaining lot frontage may be used for pedestrian amenities and shall not be used for parking.

C Min. building depth 15' from building facade

HEIGHT

D Max.

- Primary and Secondary streets 6 stories
- Tertiary streets 4 stories

Additional height available through the Bonus Height Program

Step-back

E Step-back required for all buildings fronting public streets

F Step-back after 4 stories

Min. step-back depth 15'

SIDEWALK & PLANTING

Improvements to the sidewalk corridor according to the General Standards and the Major and Collector Street Plan.

NOTES

Uses: page 61; General Standards: page 63

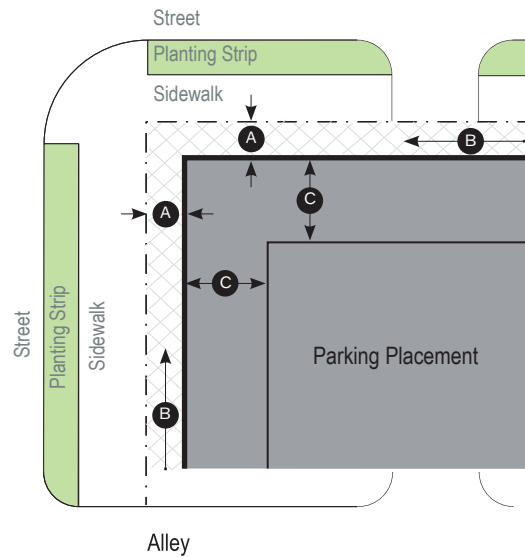

Building Plan

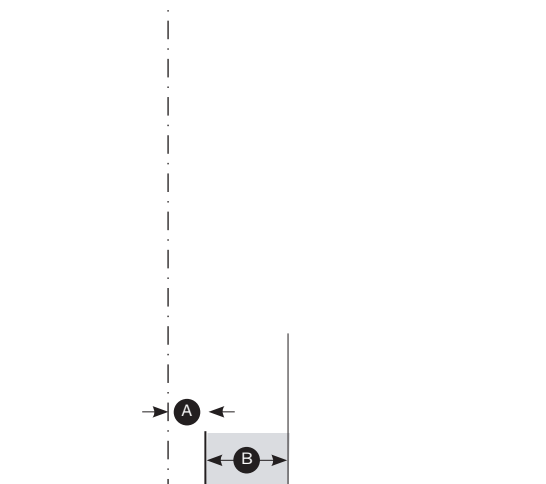

Building Section

Section II: Subdistrict Standards

Rolling Mill Hill Subdistrict: Regulating Plan

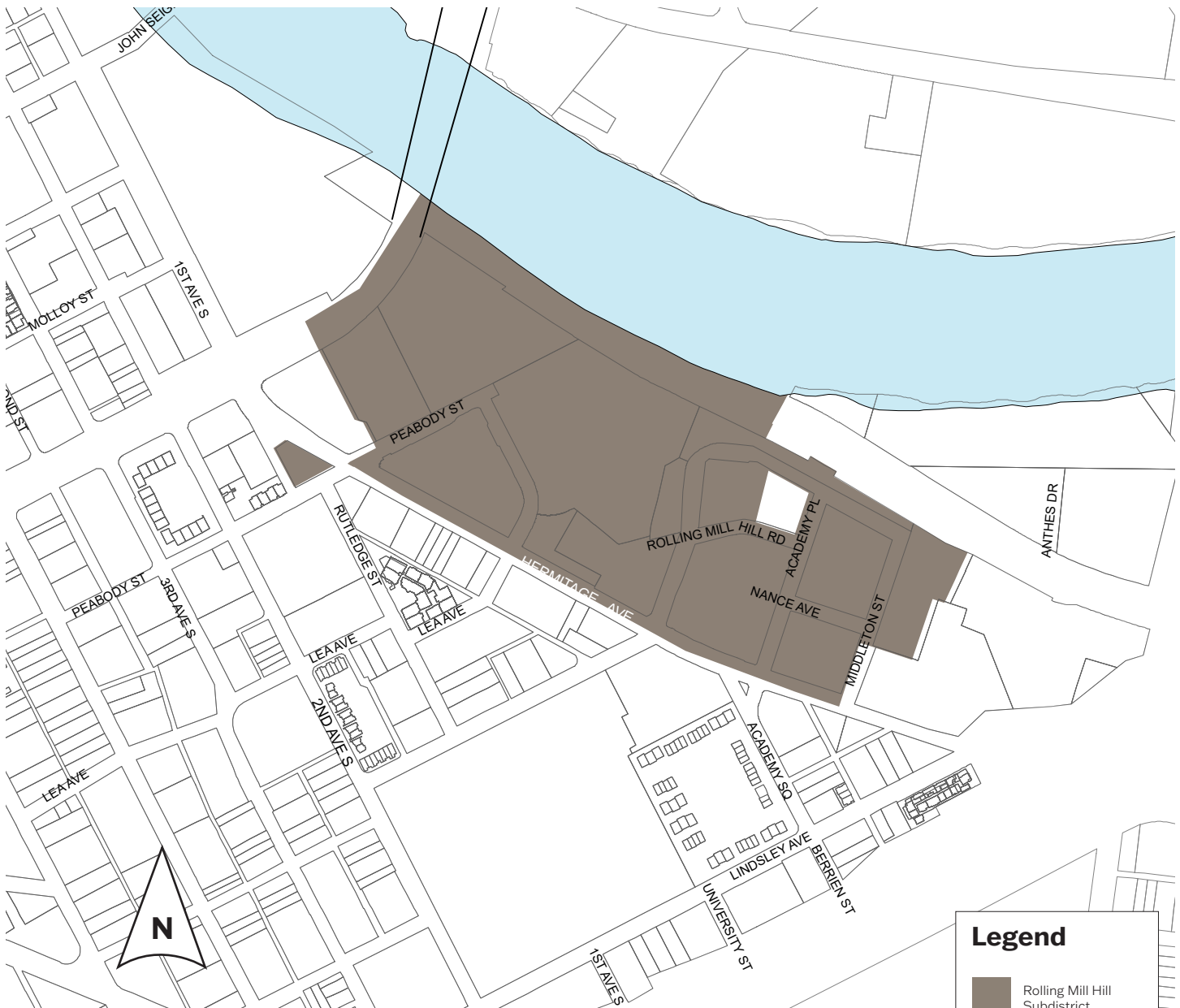

The redevelopment of the Rolling Mill Hill neighborhood is overseen by the Metropolitan Development and Housing Agency (MDHA) through the Master Plan and Development Guidelines for Rolling Mill Hill.

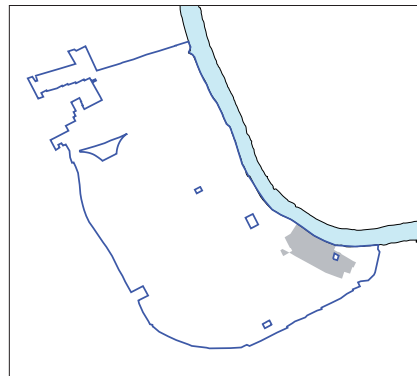

Legend	
	Rolling Mill Hill Subdistrict
	Rolling Mill Hill Historic Subdistrict
	Primary Street
	Secondary Street
	Tertiary Street
	Alley

Section II: Subdistrict Standards

Rolling Mill Hill Subdistrict: Building Regulations

FRONTAGE

- A Allowed Frontage Types with Required Build-to Zone**
All streets 0-20'

- B Facade width**
Minimum 25% of the lot frontage or 25', which ever is greater.
Remaining lot frontage may be used for pedestrian amenities and shall not be used for parking.

- C Min. building depth** 15' from building facade
A building liner is required surrounding parking structures on the ground floor facing public streets and Open Space.

HEIGHT

- D Max. height at the street** 65'

- E Height Control Plane**
Applies from all streets and Open Space.
1 foot horizontal to 1.5 feet vertical

SIDEWALK & PLANTING

Improvements to the sidewalk corridor according to the General Standards and the Major and Collector Street Plan.

NOTES

Uses: page 61; General Standards: page 63

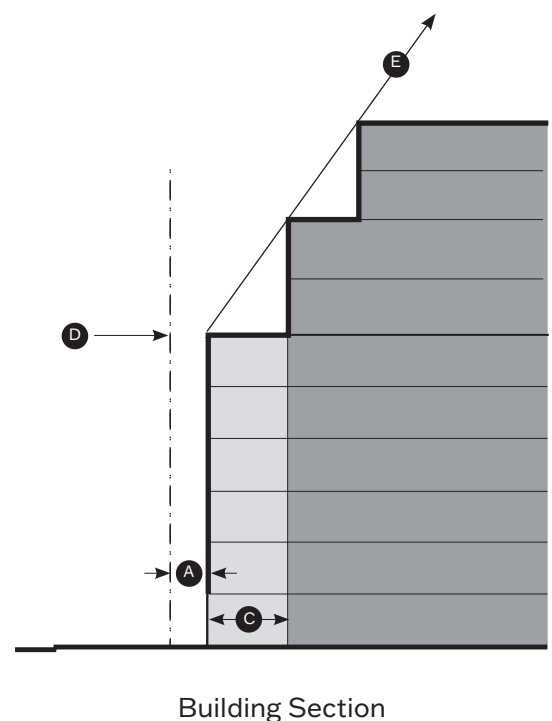
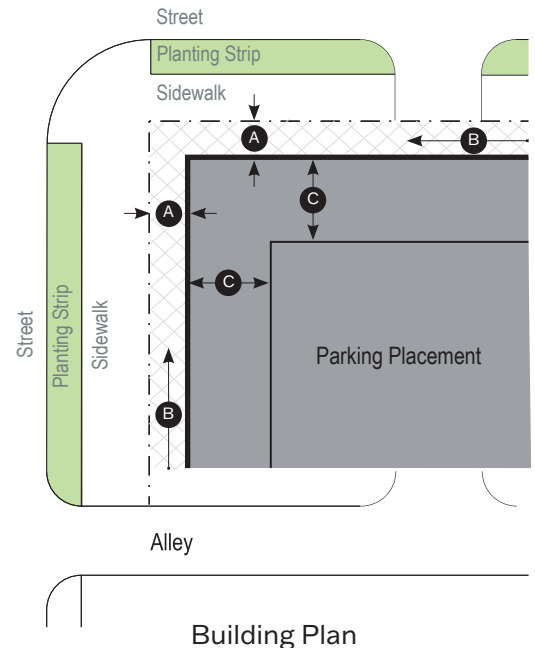

Section II: Subdistrict Standards

Rutledge River Subdistrict: Regulating Plan

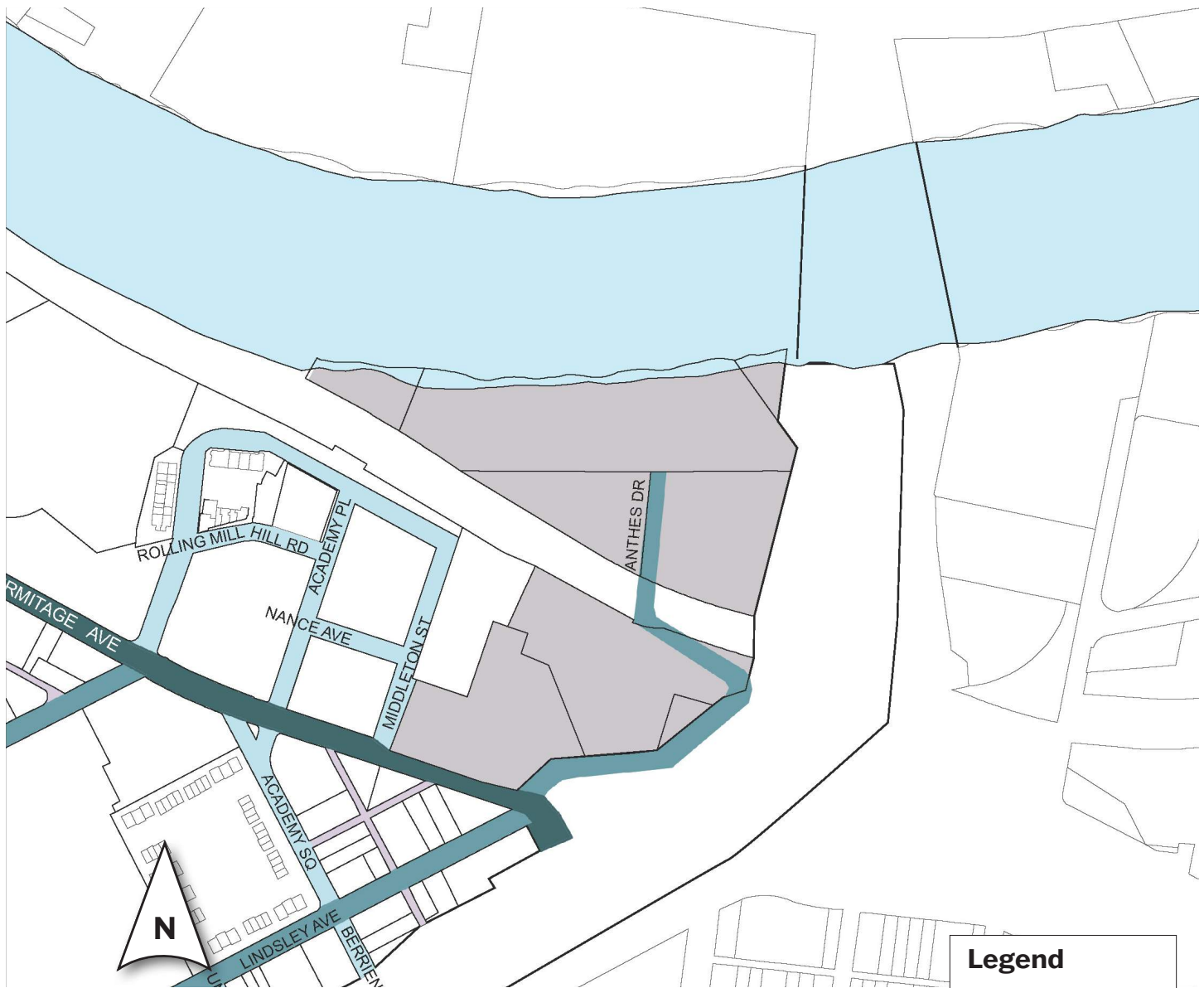

The Rutledge River neighborhood is situated in a somewhat isolated area along the Cumberland River. Redevelopment of this area should make the most of the riverside location and the adjacent commuter rail line, while preserving the historic building on Hermitage Avenue.

New streets within the Rutledge River Subdistrict shall be Secondary or Tertiary Streets.

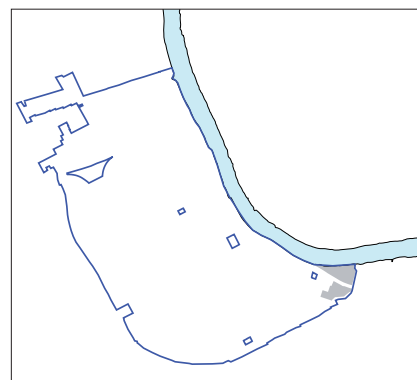

Section II: Subdistrict Standards

Rutledge River Subdistrict: Building Regulations

FRONTAGE

A Allowed Frontage Types with Required Build-to Zone

Primary Street

- Storefront Frontage 0'-10'
- Stoop Frontage 5'-10'

Secondary Street

- Storefront Frontage 0'-10'
- Stoop Frontage 5'-10'
- Porch Frontage 10'-15'

Tertiary Street

- Storefront Frontage 0'-10'
- Stoop Frontage 5'-10'
- Porch Frontage 10'-15'

Industrial Frontage is allowed in this Subdistrict.

B Facade width

- Primary Street 80% of lot frontage min.
- Secondary Street 80% of lot frontage min.
- Tertiary Street 60% of lot frontage min.

Remaining lot frontage may be used for pedestrian amenities and shall not be used for parking.

- C **Min. building depth** 15' from building facade

HEIGHT

- D **Max.** 9 stories
Additional height available through the Bonus Height Program

Step-back *

- E Step-back required for all buildings 7 stories or greater fronting public streets
 - F Step-back between 4th and 7th stories
Min. step-back depth 15'
- *see page 64 for full description

SIDEWALK & PLANTING

Improvements to the sidewalk corridor according to the General Standards and the Major and Collector Street Plan.

NOTES

Uses: page 61; General Standards: page 63

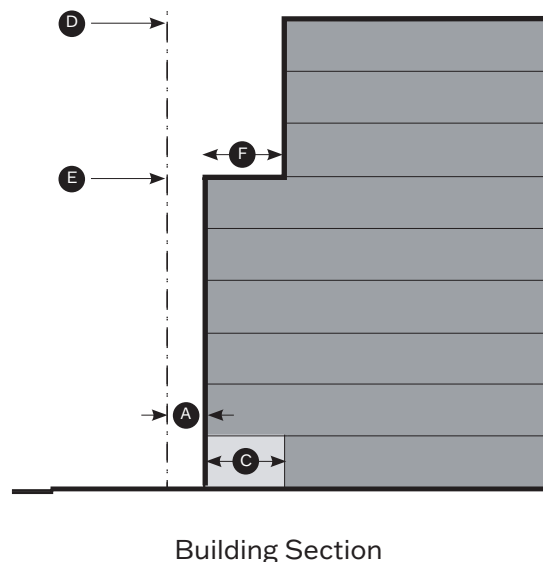
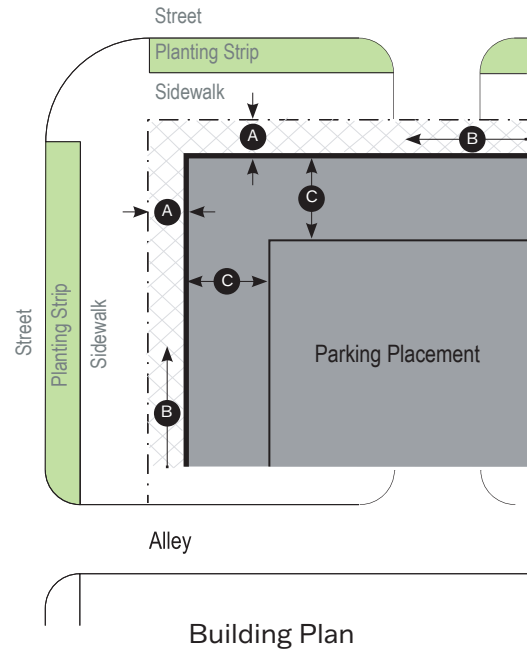





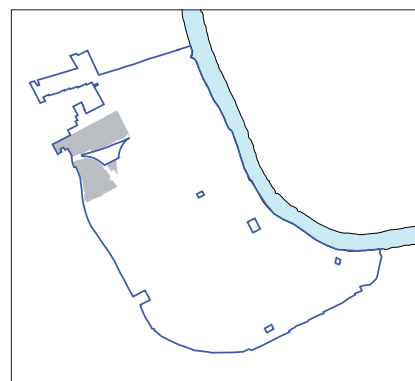

Section II: Subdistrict Standards

Gulch North: Regulating Plan



The North Gulch neighborhood is an area of transition within Downtown. Bordered on the north and west by single-family residential neighborhoods, on the east by prominent state government landmarks, and on the south by industrial, The North Gulch is envisioned to be a unique area that integrates and harmonizes these diverse uses and building types. Redevelopment of this area should make the most of the existing industrial buildings, interstate access and the internal railroad lines.



Legend	
	Gulch North Subdistrict
	Primary Street
	Secondary Street
	Tertiary Street
	Other Street
	Alley

Section II: Subdistrict Standards

Gulch North: Building Regulations

FRONTAGE

A Allowed Frontage Types with Required Build-to Zone

Primary Street

- Storefront Frontage 0'-10'
- Stoop Frontage 5'-10'

Secondary Street

- Storefront Frontage 0'-10'
- Stoop Frontage 5'-10'
- Porch Frontage 10'-15'

Tertiary Street

- Storefront Frontage 0'-10'
- Stoop Frontage 5'-10'
- Porch Frontage 10'-15'

Industrial Frontage is allowed in this Subdistrict on streets north of Harrison Street, including Harrison Street.

B Facade width

Primary Street	80% of lot frontage min.
Secondary Street	60% of lot frontage min.
Tertiary Street	60% of lot frontage min.

Remaining lot frontage may be used for pedestrian amenities and shall not be used for parking.

C Min. building depth 15' from building facade

HEIGHT

D Max. 7 stories

- Buildings fronting Herman St 4 stories

Additional height available through the Bonus Height Program

SIDEWALK & PLANTING

Improvements to the sidewalk corridor according to the General Standards and the Major and Collector Street Plan.

NOTES

Uses: page 61; General Standards: page 63

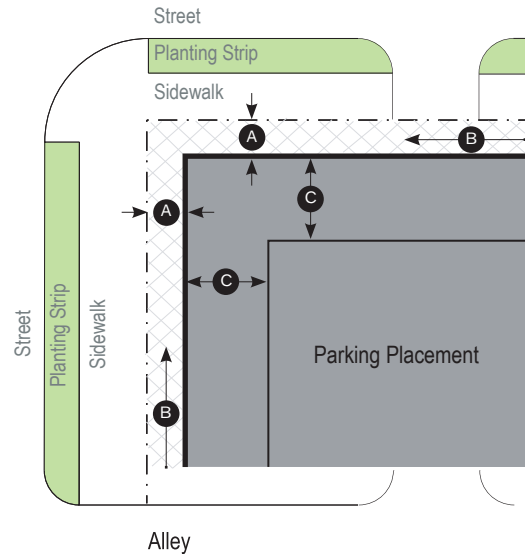

Building Plan

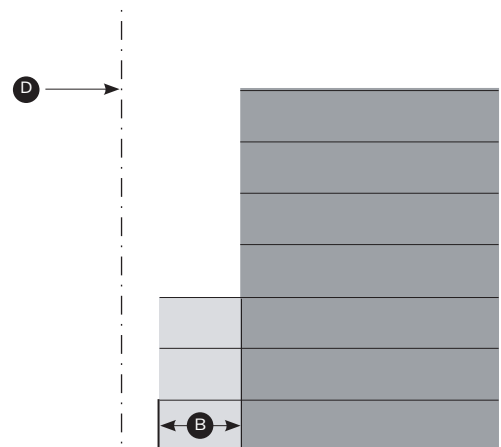

Building Section

Section II: Subdistrict Standards

Gulch South: Regulating Plan

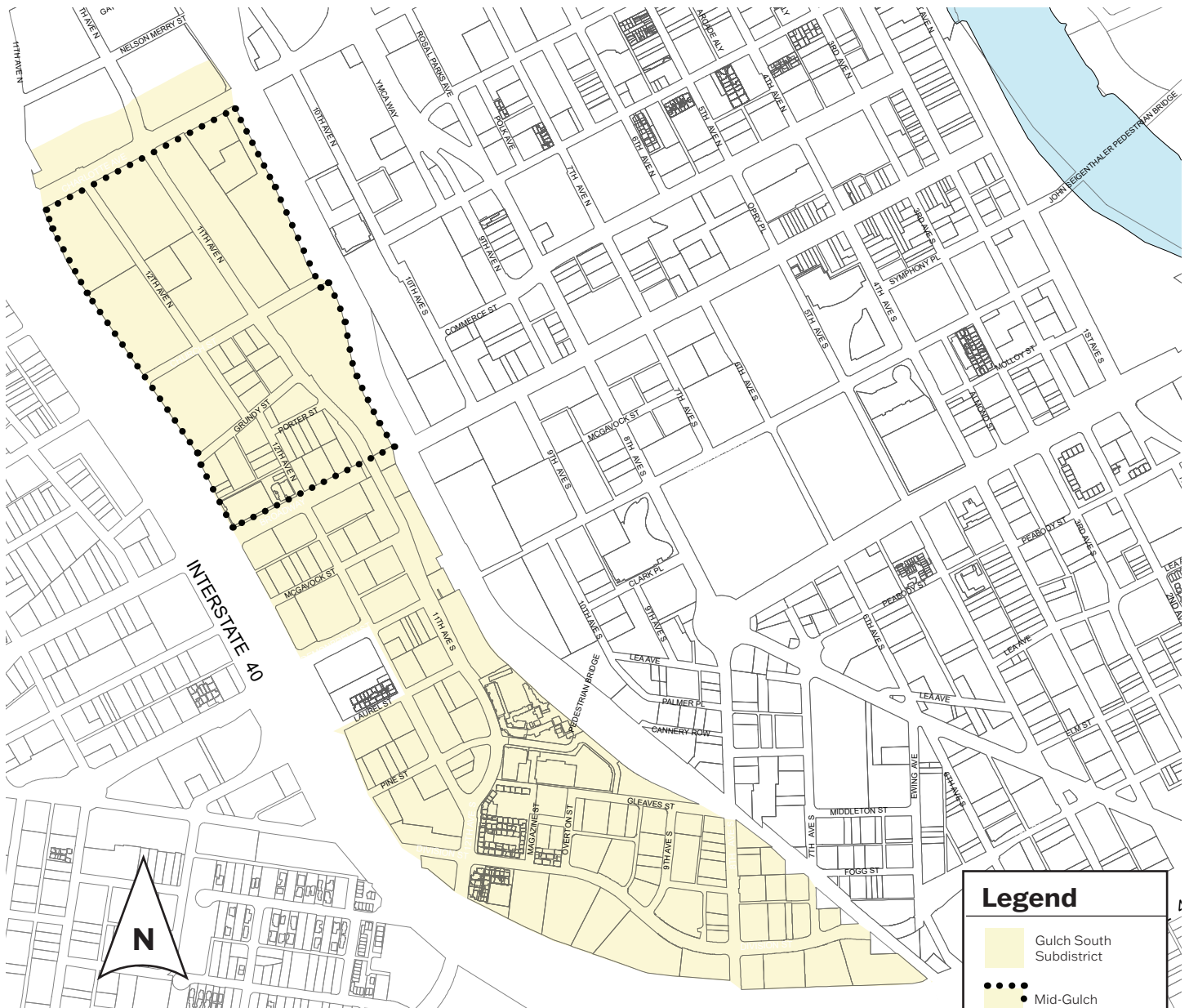

The Gulch South neighborhood is an eclectic neighborhood of business services, restaurant, and retail with many new residential buildings. The area is a link between Downtown and Midtown and is envisioned to be mixed-use mid-rise buildings with opportunities for additional height at key intersections and along important streets. Connectivity - vehicular, rail, bicycle and pedestrian - should be preserved and additional connectivity is strongly encouraged.

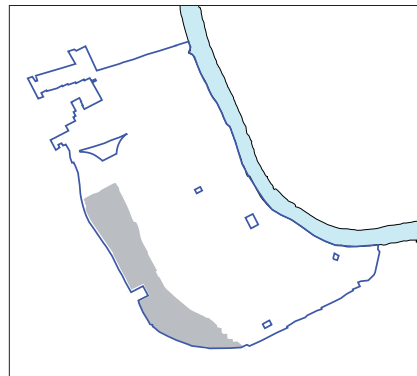

Legend

- Gulch South Subdistrict
- Mid-Gulch Properties
- Primary Street
- Secondary Street
- Tertiary Street
- Other Street
- Alley

Section II: Subdistrict Standards

Gulch South: Building Regulations

FRONTAGE

A Allowed Frontage Types with Required Build-to Zone

Primary Street

- Storefront Frontage 0'-10'
- Stoop Frontage 5'-10'

Secondary and Tertiary Streets

- Storefront Frontage 0'-10'
- Stoop Frontage 5'-10'
- Porch Frontage 10'-15'

B Facade width

Primary Street	80% of lot frontage min.
Secondary Street	80% of lot frontage min.
Tertiary Street	60% of lot frontage min.

Remaining lot frontage may be used for pedestrian amenities and shall not be used for parking.

C Min. building depth 15' from building facade

HEIGHT

D Max.

- On Church St, Broadway, Demonbreun 15 stories
- Gulch South Intersections (12th Ave and Broadway, 12th Ave and Demonbreun, 12th Ave and Division, 8th Ave and Division) 20 stories
- Mid-Gulch Intersections (11th Ave and Broadway, 11th Ave and Church, 11th Ave and Dr. MLK Boulevard) 20 stories
- Mid-Gulch Properties 10 stories
- Subdistrict General 10 stories

Additional height at intersections applies to frontage within 150 feet of the intersection. The distance from street intersections shall be measured from the nearest intersection of the existing right-of-way lines or extensions thereof. For streets designated to be widened at a future time by the adopted MCSP, measurement shall be made from the ultimate right-of-way.

Additional height available through the Bonus Height Program

Step-back*

Step-back required for buildings 8 stories or greater along public streets

- E Step-back between 4th and 8th stories
- F Min. step-back depth 15'

*see page 64 for full description

SIDEWALK & PLANTING

Improvements to the sidewalk corridor according to the General Standards and the Major and Collector Street Plan.

NOTES

Uses: page 61; General Standards: page 63

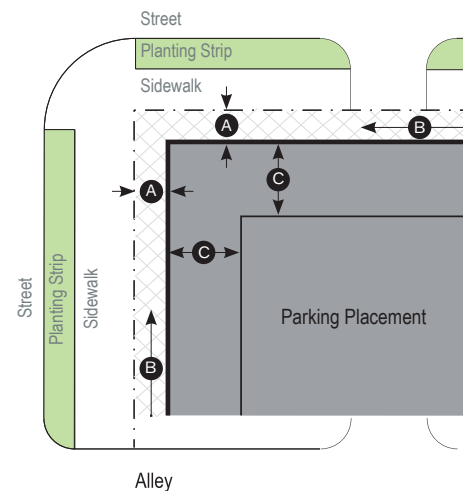

Building Plan

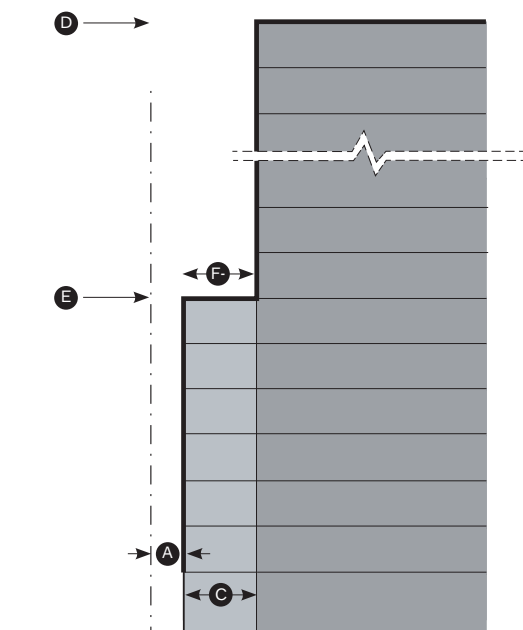

Building Section

Section II: Subdistrict Standards

Hope Gardens Subdistrict: Regulating Plan



The Hope Gardens subdistrict includes the commercial and multi-family areas surrounding the single-family residential at the center of the Hope Gardens neighborhood. Development along the major streets – Jefferson Street and Rosa Parks Boulevard – should be low-rise and should transition in height and mass near the single-family areas. The existing commercial, residential and industrial uses are all important factors within this area and can be maintained while providing opportunities for mixed-use. The harmonization of these many uses – through the regulation of the building forms – will ensure the vitality of this mixed-use neighborhood.

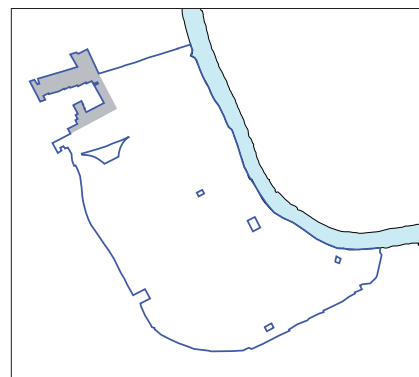

Legend

- Hope Gardens Subdistrict
- Property lines adjacent to single family neighborhood
- Primary Street
- Secondary Street
- Tertiary Street
- Alley

Section II: Subdistrict Standards

Hope Gardens Subdistrict: Building Regulations

FRONTAGE

A Allowed Frontage Types with Required Build-to Zone

Primary Street

- Storefront Frontage 0'-10'
- Stoop Frontage 5'-10'

Secondary Street

- Storefront Frontage 0'-10'
- Stoop Frontage 5'-10'
- Porch Frontage 10'-15'

Tertiary Street

- Storefront Frontage 0'-10'
- Stoop Frontage 5'-10'
- Porch Frontage 10'-15'

Industrial Frontage is allowed in this Subdistrict along Herman Street only.

B Facade width

Primary Street	80% of lot frontage min.
Secondary Street	60% of lot frontage min.
Tertiary Street	60% of lot frontage min.

Remaining lot frontage may be used for pedestrian amenities and shall not be used for parking.

C Min. building depth 15' from building facade

A building liner is required surrounding parking structures on the ground floor facing public streets and Open Space.

HEIGHT

D Max.

- Primary Street 7 stories
- Secondary Street 4 stories
- Tertiary Street 3 stories

Additional height available through the Bonus Height Program

Step-back

Step-back required for properties abutting the single family neighborhood. Step-back shall be measured from the abutting property line.

- E Step-back required after 3 stories
- F Minimum step-back depth 30'

BUFFER

Landscape Buffer

A landscaped buffer in accordance with 17.24.240 B-5 shall be required along any property line directly abutting a single or two-family zone district.

NOTES

Uses: page 61; General Standards: page 63

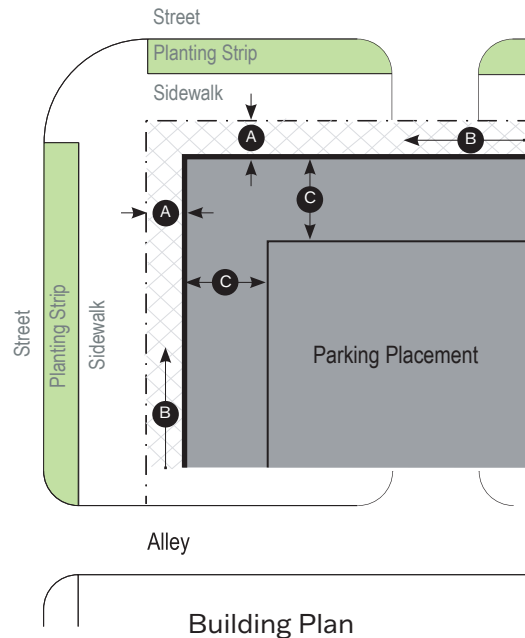

Section II: Subdistrict Standards

Sulphur Dell: Regulating Plan

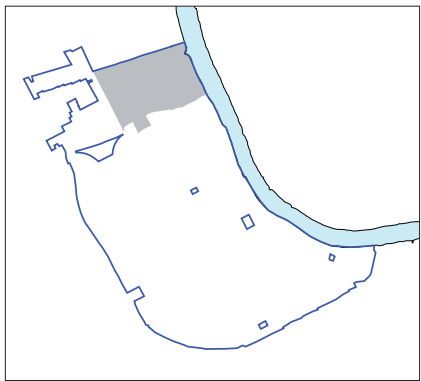
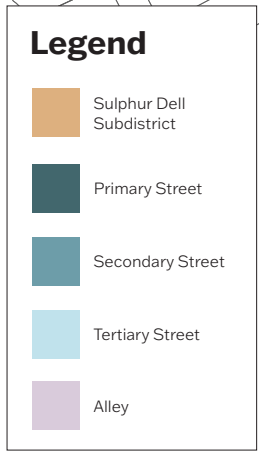
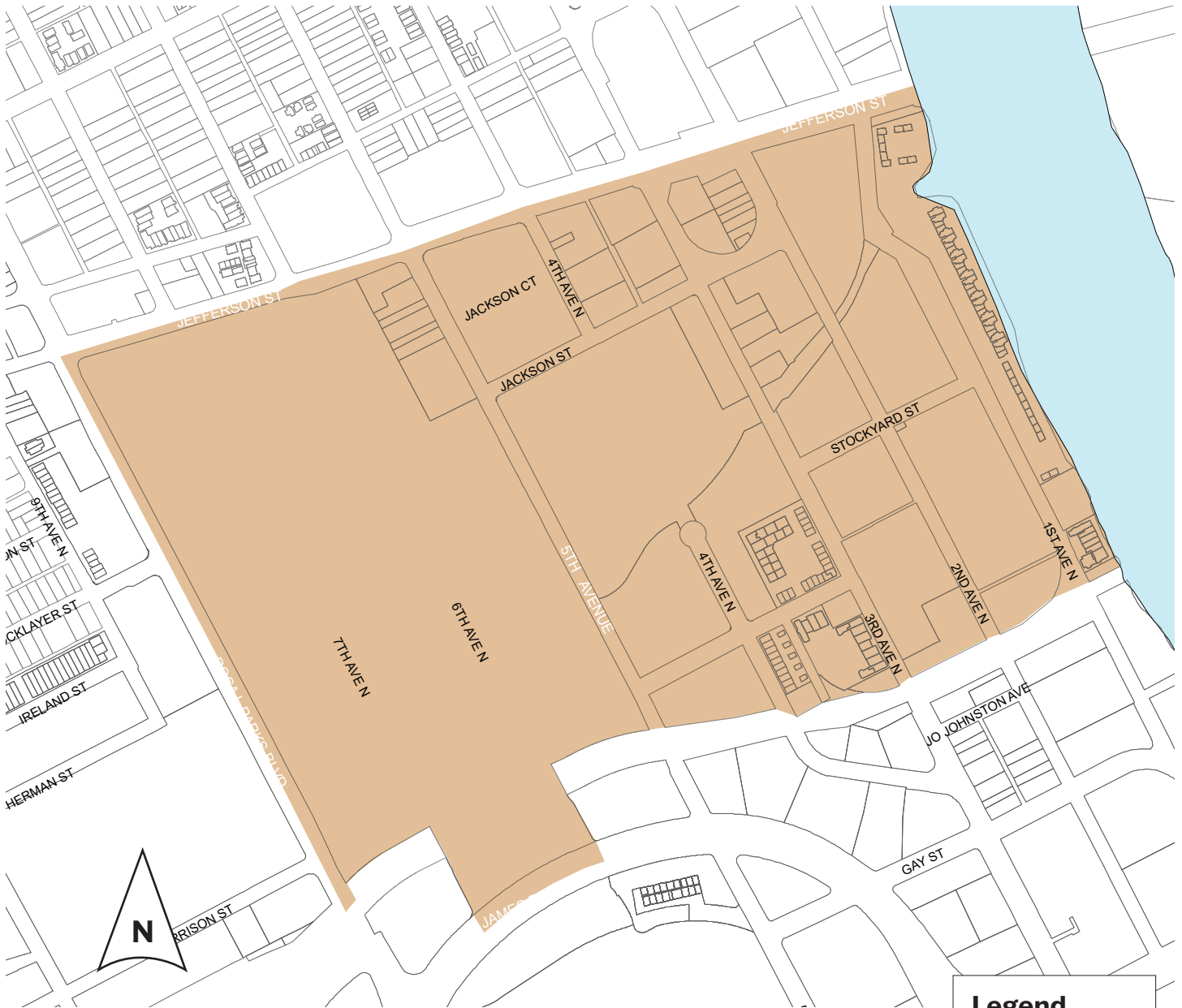

Section II: Subdistrict Standards

Sulphur Dell Subdistrict: Building Regulations

FRONTAGE

A Allowed Frontage Types with Required Build-to Zone

Primary Street

- Storefront Frontage 0'-10'
- Stoop Frontage 5'-10'

Secondary Street

- Storefront Frontage 0'-10'
- Stoop Frontage 5'-10'
- Porch Frontage 10'-15'

Tertiary Street

- Storefront Frontage 0'-10'
- Stoop Frontage 5'-10'
- Porch Frontage 10'-15'

B Facade width

Primary Street 80% of lot frontage min.

Secondary Street 80% of lot frontage min.

Tertiary Street 60% of lot frontage min.

Remaining lot frontage may be used for pedestrian amenities and shall not be used for parking.

C Min. building depth 15' from building facade

HEIGHT

D Max.

- Primary Street 7 stories
- Secondary Street 5 stories
- Tertiary Street 4 stories

Additional height available through the Bonus Height Program

SIDEWALK & PLANTING

Improvements to the sidewalk corridor according to the General Standards and the Major and Collector Street Plan.

NOTES

Uses: page 61; General Standards: page 63

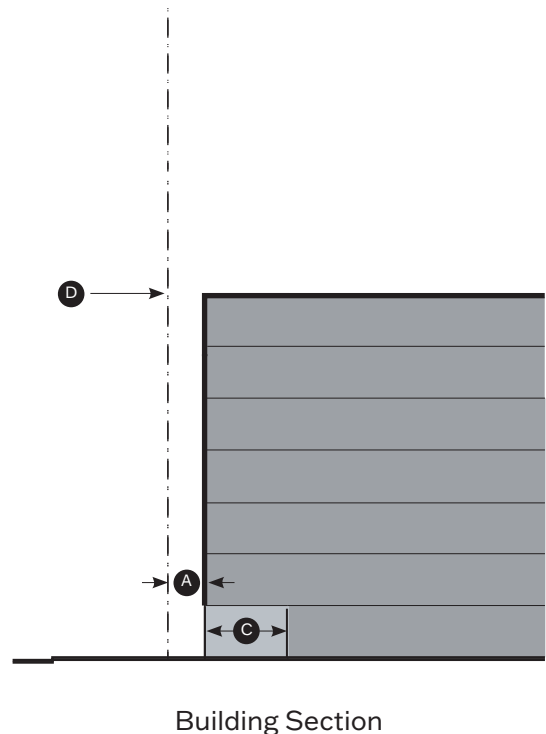
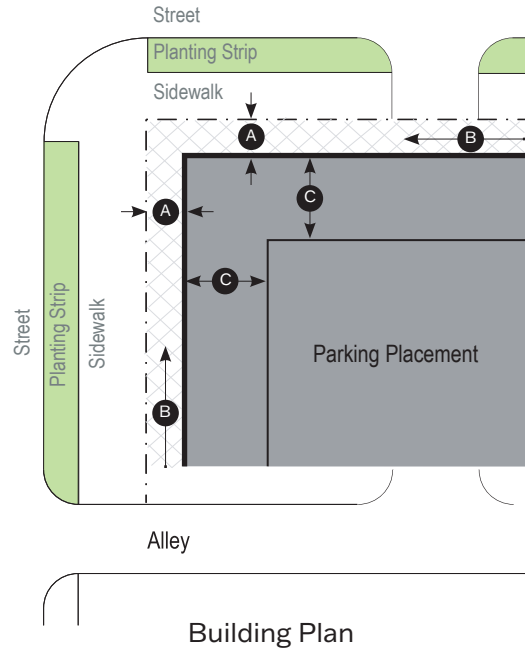

Section II: Subdistrict Standards

East Bank: Regulating Plan

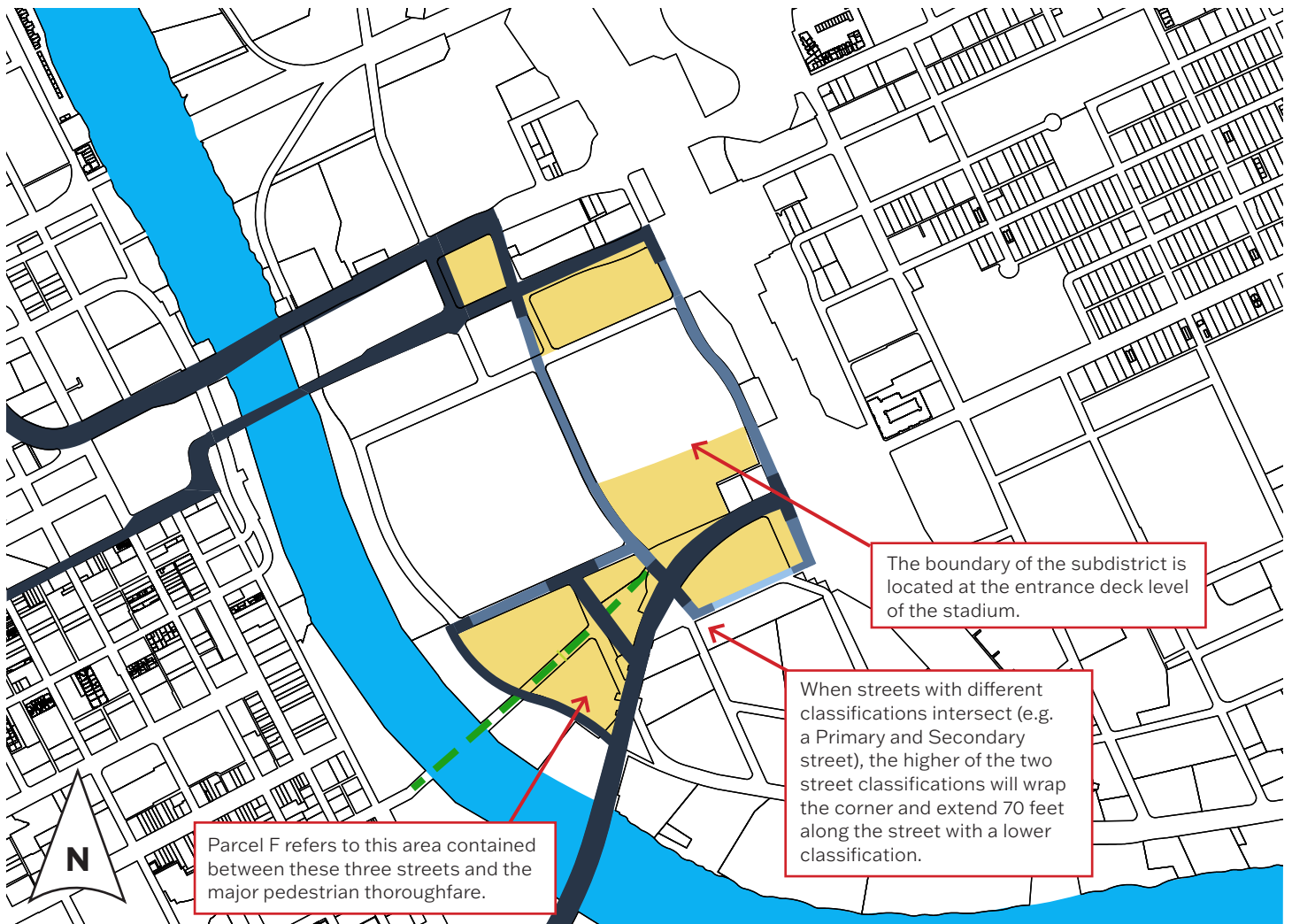

The East Bank subdistrict, situated on the east side of the Cumberland River, is an emerging neighborhood envisioned by the *Imagine East Bank Vision Plan*. While historically the East Bank's relationship with the Cumberland River has been commercial and industrial, the East Bank is a transformative opportunity to properly address the physical backdrop of the city. The East Bank is intended to create accessible public spaces, provide high-quality housing options accessible at every economic level, expand the network of locally-owned businesses throughout the city, and create a robust multimodal transportation network that will improve both local and regional connectivity.

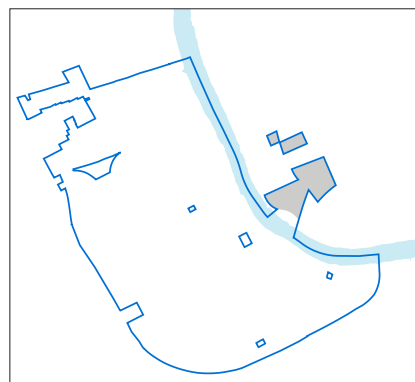

Legend

- East Bank Subdistrict
- Primary Street
- Secondary Street
- Tertiary Street
- Other Street
- Alley
- Major Pedestrian Thoroughfare

Section II: Subdistrict Standards

East Bank: Building Regulations

HEIGHT

Max. height See Diagram A
Properties within the East Bank subdistrict are ineligible to earn additional height through the Bonus Height Program.

PARKING STRUCTURES

Above-ground prohibited See Diagram B
No above-ground vehicular parking structure (lined, screened, or otherwise) shall be included in the areas described in Diagram B. If parking is to be included in these areas, it shall be located underground.

PLAZAS

Location and min. size See Diagram C
Publicly-accessible plazas, meeting the open space standards outlined in DTC Section IV: General Standards, are required in the approximate location and size described in Diagram C. All open space types are permitted within other areas of this subdistrict, provided they meet the standards referenced above.

SIDEWALK & PLANTING

Improvements to the sidewalk corridor according to the General Standards, the Major and Collector Street Plan, and the *Imagine East Bank Vision Plan* and the *Guidance for East Bank Complete Streets* document. For projects within the subdistrict, compliance with NDOT Best Practices Curb Management document should be followed, specifically regarding the design, implementation, and enforcement of short-term loading (goods movement) passenger access, metered parking, etc.

NOTES

Uses: page 63; General Standards: page 67

The DTC's existing street network is well-established, which is not the case in the East Bank subdistrict. In order to manage access and loading, mid-block alleys are strongly encouraged to be established. These alleys will ensure back-of-house operations are not street-facing.

Modifications related to the planned transit facility on Metro property within the East Bank Subdistrict shall be considered as minor modifications to allow flexibility given their specialized use.

Projects shall comply with other NDOT and Planning guiding documents and adopted policies.

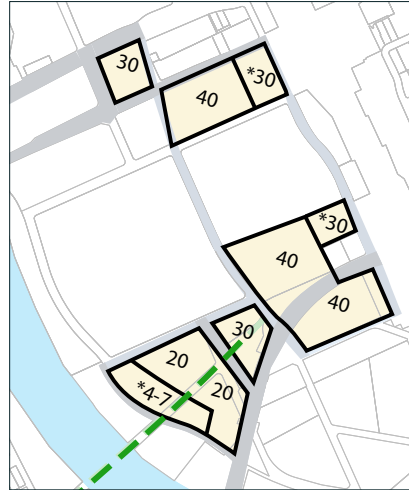

Diagram A

- 40** 40 stories max. height
- 30** 30 stories max. height
- *30** 30 stories max. height within 150' of Interstate Drive
- 20** 20 stories max. height
- *4-7** 4-7 stories max. height within 75' of Waterside Drive, except that within 100' of Korean Veterans Boulevard, the max. height shall be 20 stories.

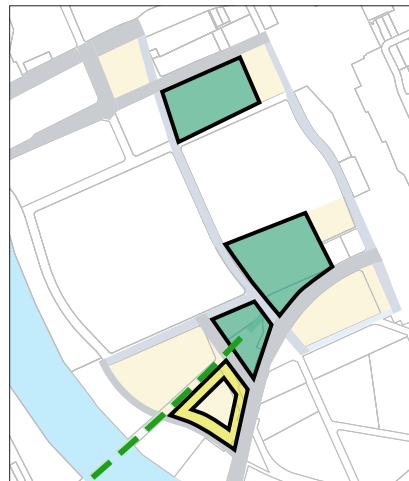

Diagram B

- Green** Above-ground vehicular parking structure prohibited
- Yellow** Above-ground vehicular parking structure prohibited, except for when it is located below an active use on an elevated frontage (Korean Veterans Boulevard, Shelby Avenue, or Major Pedestrian Thoroughfare) and fully lined on Waterside Drive. See diagram on Page 57 for intent illustration and Page 85 for additional parking requirements.



Diagram C

- 60k** 60,000 square foot plaza required
- 40k** 40,000 square foot plaza required

Section II: Subdistrict Standards

East Bank: Building Regulations

PODIUM STANDARDS

Any portion of a building below the building's required step-back, or where a step-back is not required, below the 7th story.

A Allowed Frontage Types with Required Build-to Zone

All street frontages

- Storefront Frontage 0'-10'
- Major Pedestrian Thoroughfare
- Storefront Frontage 5'-20'

*Civic Frontages are allowed and encouraged in this subdistrict. See Page 80 for details on the associated standards.

B Facade width

Primary Street	80% of lot frontage min. 90% of lot frontage max.*
Secondary Street and Open Space	70% of lot frontage min. 90% of lot frontage max.*
Tertiary Street and Major Pedestrian Thoroughfare	60% of lot frontage min. 90% of lot frontage max.*

*Maximum facade widths only apply to street or major pedestrian thoroughfare segments over 375' in length (measured from edge of intersection to edge of intersection).

Portions of a parcel's facade width that exceed the maximum facade width percentage requirement:

- shall be used for pedestrian activity and/or circulation that connects to other streets, open spaces, or pedestrian bridge.
- shall not be located at the intersection of two streets or at the intersection of a street and the pedestrian bridge.

C Min. building depth 15' from building facade

A habitable building liner is required for any side and all levels of an above-ground vehicular parking structure facing public streets, open spaces, or the pedestrian bridge.

D Building spacing 75' max., exclusive of streets

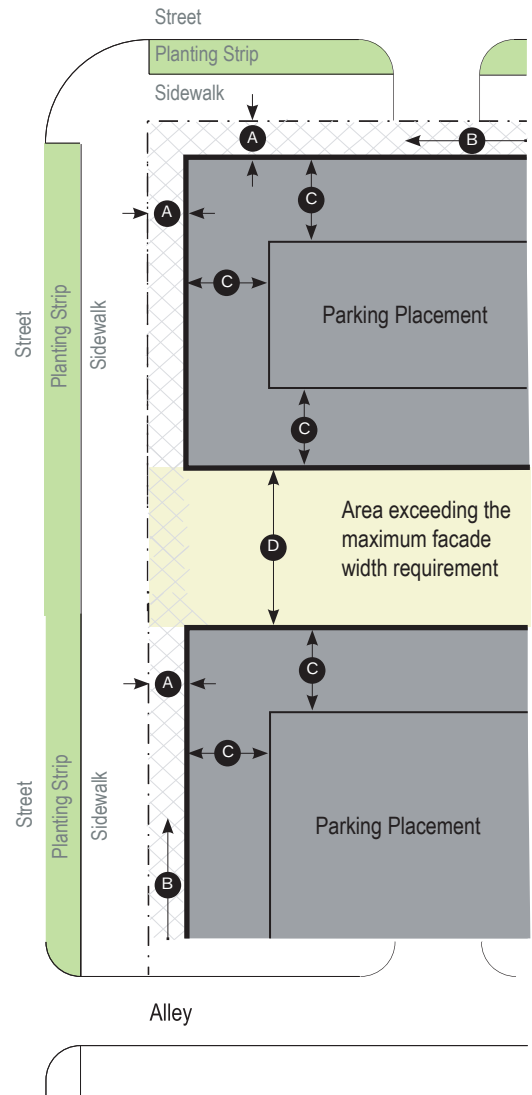

Building Plan

Section II: Subdistrict Standards

East Bank: Building Regulations

PODIUM STANDARDS CONTINUED

Any portion of a building below the building's required step-back, or where a step-back is not required, below the 7th story.

Specific to Waterside Drive frontages

The building façades shall be composed of a minimal, high-quality material palette, and those selected materials shall operate harmoniously at a human and pedestrian scale. Use of masonry is encouraged. These elevations shall be organized with a cohesive and continuous vertical rhythm of divisions along the entirety of the Waterside Drive frontage. This rhythm shall be defined by vertical articulations that consist of planar changes within the façade as well as vertically-proportioned openings.



Specific to Parcel F

Above-ground vehicular parking structure is prohibited, except for when it is located below an active use on an elevated frontage (i.e., Korean Veterans Boulevard, Shelby Avenue, or the Major Pedestrian Thoroughfare), and lined on Waterside Drive, therefore physically screened from the public realm.

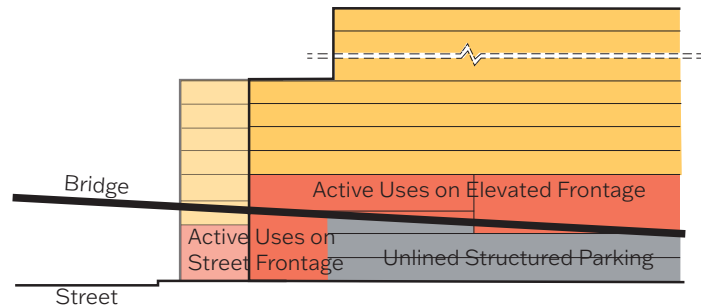

Pedestrian access and connections through Parcel F should be maximized. This includes high levels of site porosity, with meaningful connectivity from the Major Pedestrian Thoroughfare and Waterside Drive to bridge-level and below bridge-level public spaces, as well as through the parcel internally. Vertical connections between the bridge level and grade are encouraged.

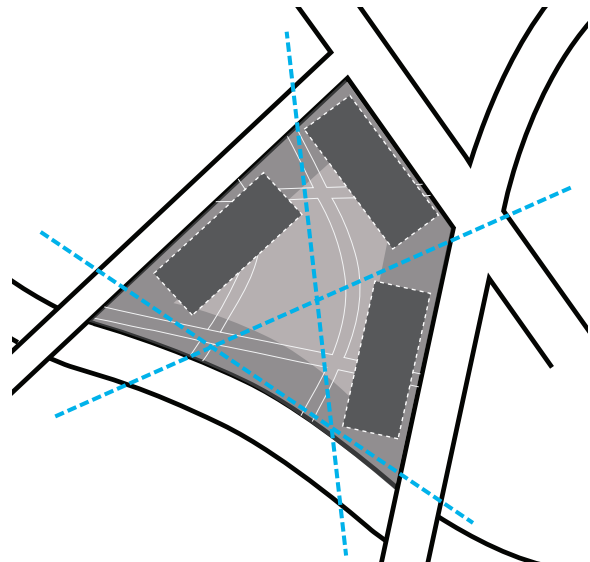

Section II: Subdistrict Standards

East Bank: Building Regulations

TOWER STANDARDS

Any portion of a building above the building's required step-back, or all stories above the 7th floor for buildings without a step-back requirement.

E Step-back

Step-back after:

- Primary Streets No step-back required
- Secondary and Tertiary Streets Encouraged, but not required
- Major Pedestrian Thoroughfare After the 7th story

F Depth:

- All street frontages No step-back required
- Major Pedestrian Thoroughfare 15'

G Max. Floorplate 16,000 Square Feet

H Max. Facade Length 200'

I Tower Spacing 75' min.

Placement & Orientation

- In order to preserve views of the Downtown skyline and the Cumberland River, tower floorplates shall maintain a ratio of between 1:1 and 3.3:1.
- The longest facade of a tower floorplate shall be oriented parallel to east-west streets or pedestrian corridors (including, but not limited to James Robertson Parkway, Main Street, Woodland Street, Korean Veterans Boulevard, Shelby Avenue, Victory Avenue, or the major pedestrian thoroughfare) for towers fronting these corridors.
- The tower floorplate ratio shall be computed by means of the smallest rectangle which will encompass the extreme limits of the floorplate's form.
- Tower floorplates that deviate from the tower floorplate ratio standards (such as office uses) may be approved via minor modification.
- Towers of significant height are encouraged to reduce their floorplate size or max. facade length at the tops of their form.

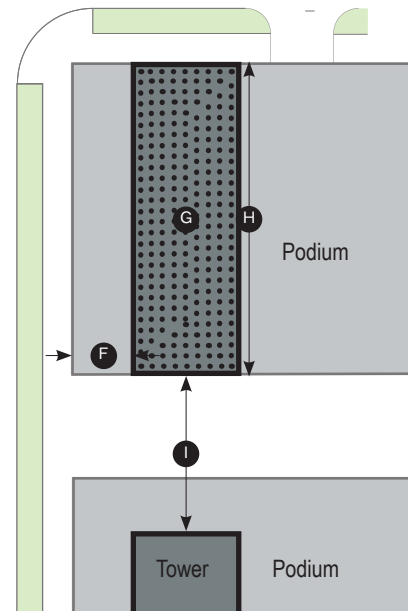
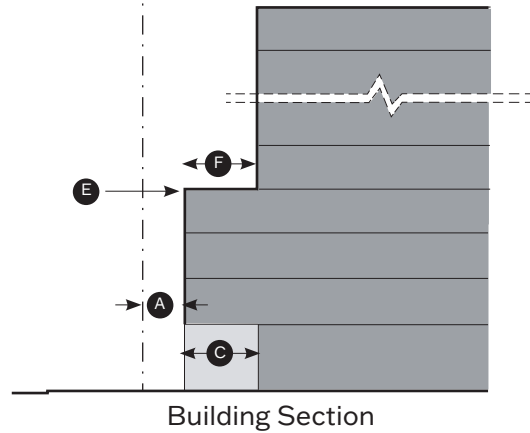

Section III: Uses

Section III: Uses

Use Areas

Land uses within the DTC are determined by Area – Central, South, West, North, and East. To create a sustainable and mixed-use Downtown, the form-based zoning of each subdistrict regulates the shape, scale, and placement of the buildings, and allows a variety of uses. Use Area boundaries are the same as Subdistrict boundaries. To determine the allowed land uses, locate the property on the Area Plan, and refer to the Area column on the Land Use Chart for the allowed uses.

In the event of a conflict between the following Land Use Chart within DTC and the Zoning District Land Use Table within Chapter 17.08, this Land Use Chart shall apply. Uses Permitted with Conditions or Permitted by Special Exceptions or Accessory shall follow the standards of Chapter 17.16. Land uses with an asterisk have conditions specific to the DTC. If standards within Chapter 17.16 and the DTC conflict, the stricter shall apply.

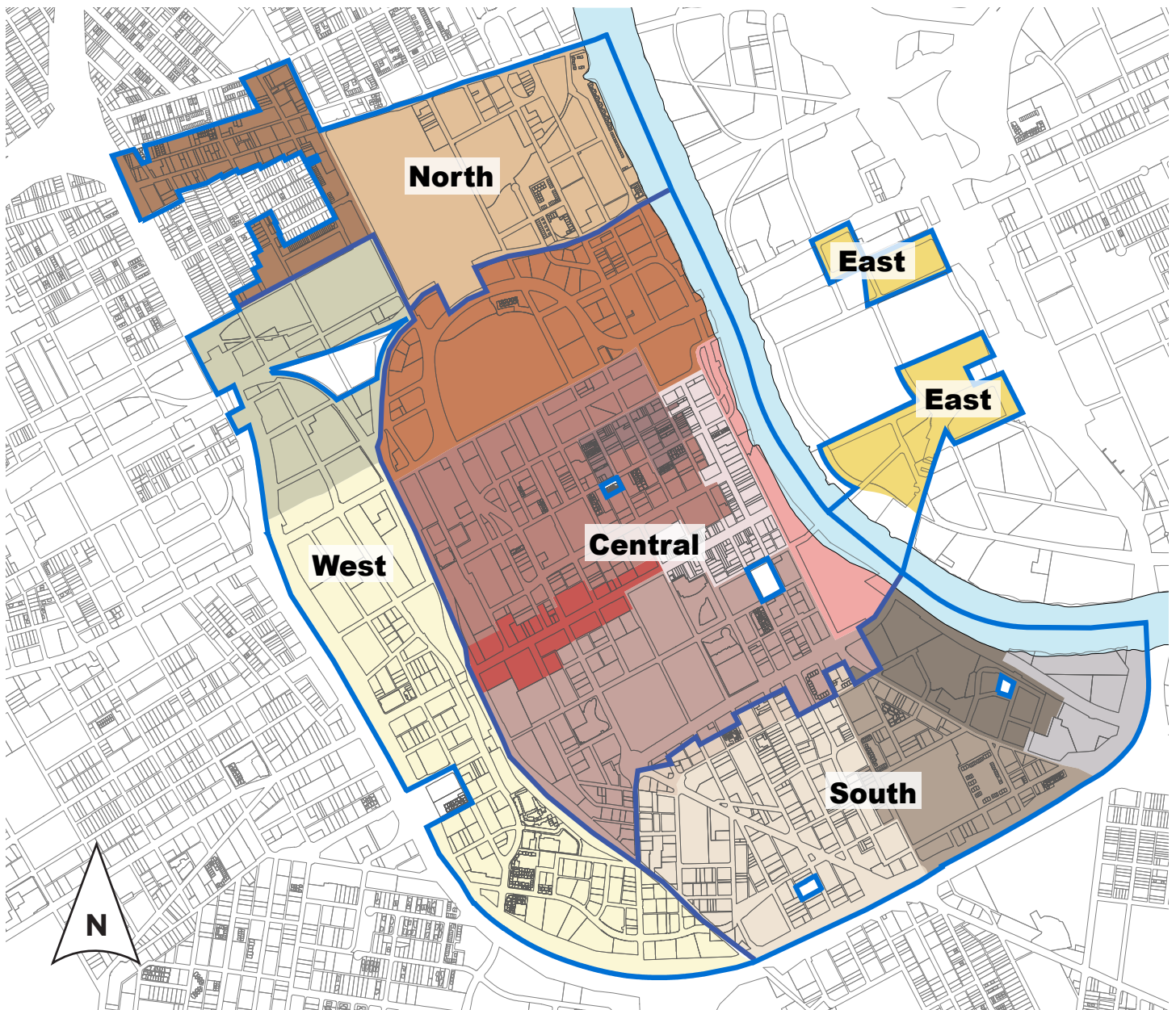

Section III: Uses

Use Tables

P: Permitted by right PC: Permitted with conditions SE: Special Exception A: Accessory O: Overlay District	North	South	East	West	Central
Residential Uses:					
Single-family	P	P		P	P
Two-family	P	P		P	P
Multi-family	P	P	P	P	P
Elderly housing	P	P	P	P	P
Mobile home dwelling					
Accessory apartment	P	P	P	P	P
Accessory dwelling, detached					
Boarding house	P	P	P	P	P
Consignment sale	P	P	P	P	P
Domesticated hens					
Garage sale	A	A	A	A	A
Historic bed and breakfast homestay	P	P		P	P
Historic home events	P	P		P	P
Home occupation	P	P		P	P
Rural bed and breakfast homestay					
Security residence					
Short-term rental property (STRP)-OO	A	A		A	A
Institutional Uses:					
Correctional facility	P	P		P	P
Cultural center	P	P	P	P	P
Day care center (up to 75)	P	P	P	P	P
Day care center (over 75)	P	P	P	P	P
Day care home	P	P	P	P	P
Day care - Parent's day out	P	P	P	P	P
School day care	P	P	P	P	P
Monastery or convent	P	P	P	P	P
Orphanage	P	P	P	P	P
Religious Institution	P	P	P	P	P
Educational Uses:	P	P	P	P	P
Business school	P	P	P	P	P
College or university	P	P	P	P	P
Community education	P	P	P	P	P
Dormitory	P	P	P	P	P
Fraternity/sorority house	P	P	P	P	P
Personal instruction	P	P	P	P	P
Vocational school	P	P	P	P	P
Office Uses:					
Alternative Financial Services					
Financial Institution	P	P	P	P	P
General Office	P	P	P	P	P
Leasing/sales office	P	P	P	P	P
Other Uses:					
Agricultural activity					
Cemetery	P	P		P	P
Mineral extraction					
On-site agricultural sales					
Pond/lake	P	P	P	P	P

P: Permitted by right PC: Permitted with conditions SE: Special Exception A: Accessory O: Overlay District	North	South	East	West	Central
Commercial Uses:					
Animal Boarding Facility	P	P		P	P
ATM	P	P	P	P	P
Auction house	P	P	P	P	P
Automobile convenience	P	P		P	P
Automobile parking	P	P	P	P	P [^]
Automobile repair	P	P		P	P
Automobile sales, new					
Automobile sales, used	P	P		P	P
Automobile service	P	P		P	P
Bar or nightclub	P	P	P*	P	P
Bed and Breakfast Inn	P	P	P	P	P
Beer and cigarette market	P	P	P	P	P
Boat storage					
Business services	P	P	P	P	P
Carpet cleaning	P	P		P	
Car Wash		PC			
Community gardening (commercial)	P	P	P	P	P
Community gardening (non-commercial)	P	P	P	P	P
Custom assembly	P	P	P	P	P
Donation Center drop-off	PC	PC		PC	PC
Flea market	P	P	P	P	P
Funeral home	P	P	P	P	P
Furniture store	P	P	P	P	P
Grocery store	P	P	P	P	P
Home improvement sales	P	P	P	P	P
Hotel/motel	P	P	P	P	P
Inventory stock	A	A	A	A	A
Kennel/stable					
Liquor stores	P	P	P	P	P
Major appliance repair	P	P	P	P	P
Mobile storage unit	PC	PC		PC	PC
Mobile vendor					
Restaurant, fast-food	P	P	P*	P	P
Restaurant, full-service	P	P	P*	P	P
Restaurant, take-out	P	P	P*	P	P
Retail	P	P	P	P	P
Self-service storage	P	P		P	P
Short-term rental property (STRP) Not OO	PC	PC		PC	PC
Vehicular rental/leasing					
Vehicular sales and services, limited		P	P	P	P
Wrecker services		P			

* For purposes of this section, "Bar" shall mean a business property at which less than 50 percent of the total revenue is generated by food sales and holding either (a) a limited service restaurant permit issued by the Tennessee Alcoholic Beverages Commission or (b) a beer permit for on premises consumption if not licensed by the Tennessee Alcoholic Beverage Commission. "Total Square Footage" shall mean the sum of the interior first and second floor areas of all buildings located on the parcels within the area marked as East on Exhibit 1 excluding (a) those located on Parcel C and (b) hotels. No more than 25% of the Total Square Footage may be occupied at any time by Bars.

[^] In the boundaries of the Second Avenue Historic Preservation Overlay, automobile parking as the Principal Use or stand alone use is not permitted.

Section III: Uses

Use Tables

P: Permitted by right PC: Permitted with conditions SE: Special Exception A: Accessory O: Overlay District	North	South	East	West	Central
Medical Uses:					
Animal hospital					
Assisted care living	P	P	P	P	P
Hospice	P	P	P	P	P
Hospital	P	P	P	P	P
Medical appliance sales	P	P	P	P	P
Medical office	P	P	P	P	P
Medical or scientific lab	P	P	P	P	P
Nonresidential drug treatment facility	P	P	P	P	P
Nursing home	P	P	P	P	P
Outpatient clinic	P	P	P	P	P
Rehabilitation services	P	P	P	P	P
Residence for handicapped, more than eight	P	P	P	P	P
Veterinarian	P	P	P	P	P
Communication Uses:	P	P		P	P
Amateur radio antenna	P	P		P	P
Audio/video tape transfer	P	P	P	P	P
Communications hut	PC	PC	PC	PC	PC
Multi-media production	P	P	P	P	P
Printing and publishing	P	P	P	P	P
Radio/TV studio	P	P	P	P	P
Satellite dish	P	P	P	P	P
Telecommunication facility	PC	PC	PC	PC	PC
Industrial Uses:	P	P	P	P	P
Artisan distillery	P	P	P	P	P
Asphalt plant					
Building contractor supply	PC	PC		PC	
Compressor station					
Concrete plant					
Distributive business wholesale	PC	PC		PC	
Fuel storage	A	A		A	P
Heavy equipment, sales and services					
Hazardous operations					
Manufacturing, artisan	PC	PC	PC	PC	
Manufacturing, heavy					
Manufacturing, medium					
Microbrewery	P	P	P	P	P
Research services	P	P	P	P	
Scrap operation					
Tank farm					
Tasting room					
Warehouse	PC	PC		PC	
Waste Management Uses:					
Collection center					
Construction/demolition landfill:					
Construction demolition waste processing	PC	PC		PC	PC
Medical waste	A	A	A	A	A
Recycling collection center	P	P		P	P
Recycling facility					
Sanitary landfill					
Waste transfer					

P: Permitted by right PC: Permitted with conditions SE: Special Exception A: Accessory O: Overlay District	North	South	East	West	Central
Transportation Uses:					
Airport, medium or large commercial service					
Airport/heliport					
Boat dock (commercial)	P	P	P		P
Bus station/landport	P	P	P	P	P
Bus transfer station	P	P	P	P	P
Commuter rail	P	P	P	P	P
Helistop	SE	SE	SE	SE	SE
Motor freight					
Park and ride lot					
Railroad station	SE	SE	SE	SE	
Railroad yard					
Water taxi station	P	P	P	P	P
Utility Uses:					
Power/gas substation	P	P	P	P	P
Power plant	A	A	A	A	A
Reservoir/ water tank	P	P	P	P	P
Safety services	P	P	P	P	P
Waste water treatment	SE	SE	SE	SE	SE
Water/sewer pump station	P	P	P	P	P
Water treatment plant	SE	SE	SE	SE	SE
Wind energy facility (small)	PC	PC	PC	PC	PC
Wind energy facility (Utility)			P		
Recreation and Entertainment Uses:					
Adult entertainment	O	O		O	O
After hours establishment	PC	PC		PC	PC
Camp					
Club	P	P	P	P	P
Commercial amusement (inside)	P	P	P*	P	P
Commercial amusement (outside)	P	P	P*	P	P
Country club	P	P	P	P	P
Drive-in movie					
Driving range					
Fairground					
Golf course					
Greenway	P	P	P	P	P
Park	P	P	P	P	P
Racetrack					
Recreation center	P	P	P	P	P
Rehearsal hall	P	P	P	P	P
Sex club					
Small outdoor music event			P		
Stadium/arena convention center	P	P	P	P	P
Temporary festival	P	P	P	P	P
Theater	P	P	P	P	P
Theatre					
Zoo					

Section IV : General Standards

Section IV: General Standards

Calculations

Measurement from “Grade”

- Unless otherwise indicated, reference to measurements from “grade” shall be calculated using the average elevation along the public right-of-way fronting the property. Thus, grade will generally be measured from the public sidewalk, not from grade on site.
- When buildings are set back from the property line more than 15 feet, grade shall be measured as the average existing elevation at the building facade.
- In the event that the base flood elevation, as established by FEMA, is higher than the sidewalk or grade elevations, the height of the first story, shall be measured from 1 foot above the base flood elevation.
- The minimum ground floor height for all frontage types is 14 feet from grade.

Measurement of Height

- Unless otherwise specified herein, the height of buildings shall be measured in stories.
- The maximum height for an individual story shall not exceed 25 feet from finished floor to finished floor for each of the first 2 stories, 18 feet floor to floor above the second story, and 25 feet for the top story of buildings greater than 5 stories.
- The minimum building height shall be 25 feet. This applies to all buildings except those designed for single-family use, two-family use, or multi-family use with residential on the ground floor.
- The maximum height for a raised foundation is 6 feet above grade.
- Basements are not considered stories for the purposes of determining building height.
- Building height shall be measured from each Street Frontage (excluding Other streets alleys) or Open Space.
- The height of a parking structure concealed by a building liner may be equal to the height of the liner, regardless of the number of stories. If there is no liner to conceal the parking structure, its height is limited by the maximum number of stories allowed.
- The height of fences, walls and hedges shall be measured in feet from the average sidewalk elevation.

Step-backs

- If a building step-back is specified to occur between a range of stories, that range shall include the lower and upper story bounds. For example, the James Robertson Subdistrict specifies a 15’ step-back between the 4th and 8th stories. Therefore the required stepback can occur on the 4th, 5th, 6th, 7th, or 8th story.
- To allow for facade variation, stories within the range may be permitted to step-back to a lesser extent or not at all, so long as the minimum step-back depth is met by the upper story bound of the required step-back range.

Fenestration and Glazing

- Except as specifically referenced herein, façade glazing and opening standards shall include windows, doors and openings in parking structures and shall apply to all areas of the building façade facing a public street or open space (excluding Other streets and alleys) as follows:
 - » First Floor: façade area measured from the finished floor to a height 14 feet above the finished floor.
 - » Upper Floors: façade area from finished floor to finished floor.
 - » Openings for vehicular access to parking structures on the first floor shall not be included in calculation of total façade area or glazed area.
 - » The DTC recognizes the need for building systems and functionality including interior mechanical systems, fire safety egress, other building code issues and their impact of the feasibility of building fenestration. Areas of the façade affected by these elements shall not be counted toward minimum glazing requirements.

Section IV: General Standards

Street Character

The public right-of-way, including streets, sidewalks and public utility infrastructure, plays both a functional and social role in the life of the city and its citizens. Streets organize the city, help to define space, and link destinations. The street is also a public place where people congregate, shop, socialize and live. Active, attractive streets are critical to the continued growth and success of Downtown. The DTC includes urban design tools to make working, living and playing in Downtown lively, safe and comfortable.

The DTC uses Street Types as an urban design and organizing tool. All streets are classified on the Regulating Plan as Primary, Secondary, Tertiary, Other, or Alley.

Where alleys exist and are in working condition, or where new alleys can be created, the DTC prioritizes alleys for access and loading. The location of vehicular access from all other streets shall be determined on a case-by-case basis.

The Downtown Plan: 2007 Update calls for “a strong emphasis on expanding other modes of transportation including walking, cycling and transit.” The DTC emphasizes walking, cycling and transit as primary modes of transportation within Downtown through the urban design of individual buildings, blocks, and neighborhoods.

All Streets

- Streets refer to publicly or privately owned right-of-way. They are intended for use by pedestrian, bicycle, transit and vehicular traffic and provide access to property.
- Streets consist of vehicular lanes and the Sidewalk Corridor. The vehicular lanes, in a variety of widths, provide traffic and parking capacity and may include bicycle paths. The Sidewalk Corridor contributes to the urban character of each neighborhood. It may include pedestrian paths, landscaped planters, street furnishings and street trees.
- Pedestrian safety, comfort, and accessibility should be a primary consideration of street design and dimensioning.
- When alleys are present, vehicular access from alleys is preferred. Vehicular access from public streets shall be considered in the following order: Other Streets, Secondary Streets, Tertiary Streets and then Primary Streets as approved by Metro departments.



Section IV: General Standards

Street Character

Street Types

- **Primary Street:** Primary Streets accommodate high levels of pedestrian activity and high levels of vehicular traffic. On Primary Streets, active uses – residential, retail, restaurant or office – lining parking structures and on the first floor of buildings, and restricted vehicular access enhance the pedestrian experience. Primary streets provide the opportunity for more intense, urban development including shallow Build-to Zones and, in some cases, increased building height. Pedestrian comfort on these streets is of highest importance. Primary streets should have a continuous street wall, wide sidewalks between 15 and 20 feet to provide room for street furniture such as benches, trash receptacles, and bicycle parking. Primary Streets have the highest level of urban activity such as, outdoor dining, retail displays, and community activities like markets, parades, and music. Street trees provide protection from the sun and rain, reduce stormwater runoff and air pollution, and provide aesthetic value to the city. Trees should be planted in wells with tree grates to allow for the uninterrupted flow of pedestrian traffic.
- **Secondary Street:** Secondary Streets have moderate levels of pedestrian activity and moderate levels of vehicular traffic. Secondary Streets may be mixed-use or more residential in character. The Build-to Zone is generally shallow, and building heights are limited. In mixed-use areas, a continuous street wall should be maintained and sidewalks should be between 12 and 15 feet wide to accommodate pedestrian traffic. In residential areas, the required minimum façade width is limited – allowing for more space between buildings – and sidewalks may be narrower. Both tree wells and open landscaped planters are appropriate depending on sidewalk width.
- **Tertiary Street:** Tertiary Streets are the less important than Primary and Secondary streets. They may function as “back of house” for buildings with multiple street frontages. Care should be taken to make these streets as pedestrian-friendly as possible while accommodating loading and access needs.



Broadway is a Primary Street due to the high intensity of urban activity.



Third Avenue south of Broadway is a Secondary Street within a mixed-use area.



Ninth Avenue North is a Secondary Street within a residential area.

Section IV: General Standards

Street Character

- **Other Street:** Other Streets are streets that do not fall into any of the other street categories. They may have high or moderate levels of vehicular traffic, but often have no access to property and limited pedestrian activity. Building height along these streets is regulated by the other property frontages. Buildings do not front on these streets and may be built up to the property line.
- **Alley:** Alleys are service roads that provide shared access to property. Public utilities as well as access to mechanical equipment and trash should be located off an alley whenever possible. Where alleys exist and are in working condition, or where new alleys can be created through the dedication of new right-of-way, alleys are prioritized for access and loading.



Other Streets are less traveled by pedestrians and have limited access for vehicles from adjoining lots.

Sidewalk Corridor

- The Sidewalk Corridor is the portion of the right-of-way between the vehicular lanes and the property line or building façade.
 - » The primary function of the Sidewalk Corridor is to provide a safe, comfortable, and convenient route for pedestrian travel that is separated from vehicular movements.
 - » The Sidewalk Corridor is a public space that should include pedestrian amenities such as seating, shade trees, places to congregate, trash receptacles and outdoor dining.
 - » The Sidewalk Corridor may accommodate public utilities such as electric poles and vaults, water and sewer lines, bus stops and traffic signals.
- As property develops within the DTC boundaries, property owners shall consult with Metro Planning and Public Works to make the necessary improvements to the streetscape in accordance with *the Major and Collector Street Plan*, *the Downtown Streetscape Elements Design Guidelines*, *the Strategic Plan for Sidewalks and Bikeways* and Title 17.20.120 Provision of sidewalks.



Alleys provide access for parking and service areas.

Section IV: General Standards

Street Character

Street Trees

Shade-producing street trees shall be planted in the public right-of-way along the length of the lot frontage at a maximum spacing of fifty feet and a maximum spacing of thirty feet within the East Bank subdistrict or in accordance with the regulations of Metro departments and agencies.

Tree Quality

Tree species shall be chosen from the *Urban Forestry Recommended and Prohibited Tree and Shrub List* based on tree size and planting area provided or an alternative species deemed appropriate by the Urban Forester.

- At planting trees, shall meet the requirements for street trees set out in the *American Standard for Nursery Stock*.
- All nursery stock used as street trees shall be vigorous, healthy and free of diseases or infestation.
- Planting Area Dimension
 - » The following standards are minimum standards. All development is encouraged to provide street trees with the largest area of pervious surface and volume of soil that can be accommodated.
 - » Trees shall be accommodated in planting areas with a minimum depth of 3 feet and a minimum soil volume of 400 cubic feet.
 - » The minimum pervious opening at grade shall be 24 square feet.
 - » Tree vaults shall have the capability to drain water.
 - » Planting areas shall not inhibit ingress/egress from buildings or pedestrian traffic along the Sidewalk Corridor.

Future Streets

Downtown thrives on a connected system of streets which allow easy access within neighborhoods and to other parts of the city. There are, however, places for improvement. The Future Streets Plan shows how streets could be realigned, connected and created in the future to improve mobility within Downtown.

Properties near an area highlighted for change on the Future Streets Plan shall consult with the Planning Department and the Department of Public Works to discuss the potential change.

Future streets within the East Bank subdistrict shall follow the dimensions established by *Imagine East Bank*.

Multimodal Transportation Network

Downtown is envisioned to accommodate all modes of travel with an emphasis on multimodal transportation. As property develops, properties shall implement the Priority Bike Network recommendations of the WalknBike Nashville plan.

Section IV: General Standards

Future Streets Plan

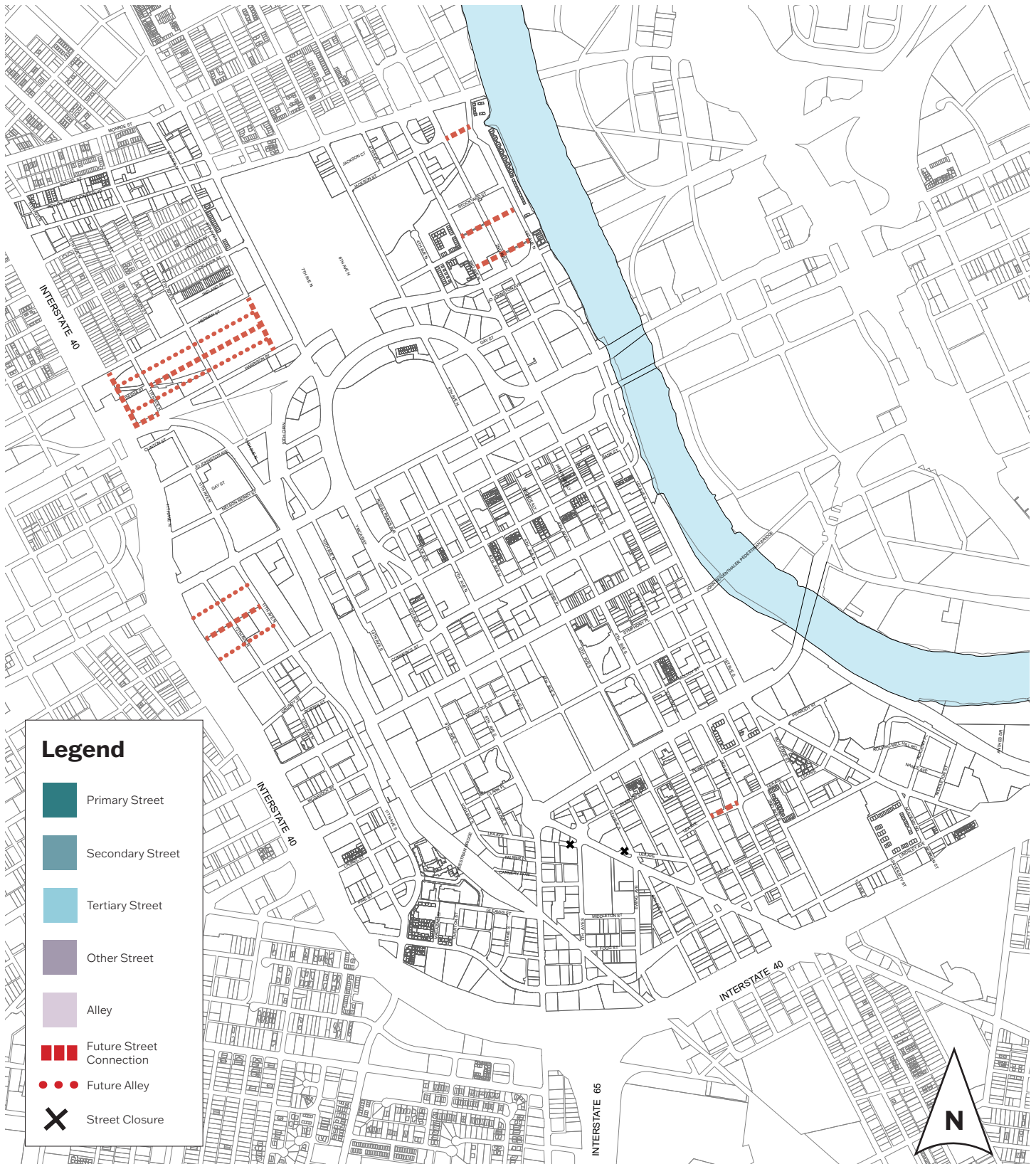

Section IV: General Standards

Lots and Frontages

Frontages

A Frontage is the specific way in which the building face addresses the street. It is the transition and interaction between the private and public realms. Building Frontages define the character and form of the public spaces within each neighborhood. The following standards shall apply to all development within the DTC.

- Buildings shall front a street (excluding alleys), open space, or a pedestrian passage.
- Principal and Minor Frontages
 - » Every property shall establish one Principal Frontage along a street.
 - » When a lot fronts more than one street the following priority shall be given when establishing the Principal Frontage: Primary Street, Secondary Street, Tertiary Street, Other Street.
 - » Any other frontage(s) shall be treated as a Minor Frontage.
 - » In the instance a property fronts multiple Primary streets, any may be chosen as the Principal Frontage or all may be treated as the Principal Frontages.
 - » Along a Minor Frontage, the façade width may be reduced to the maximum depth of the building along the Principal Frontage. The remaining lot width shall be defined with a knee-wall according to the Walls and Fences section of the DTC.
 - » Along a Minor Frontage, modifications may be granted for the reduction of ground level garage liners and/or glazing requirements.
- Façade Width
 - » The minimum façade width is the minimum amount of the frontage that must be defined by a building and is designated as a percentage of the frontage.
 - » If a single lot frontage is greater than two hundred feet, the façade width may be reduced to a minimum of one hundred and fifty feet in length.
- Open Space Frontages
 - » When building facades front on open space the standards of the adjacent street type (excluding Tertiary) shall apply unless otherwise noted.

- » All buildings fronting open space shall have a minimum of one primary pedestrian entrance on the open space.
- Pedestrian Passage Frontages
 - » When building facades front on a pedestrian passage the standards of the adjacent street type (excluding Tertiary) shall apply.
 - » All buildings fronting a pedestrian passage shall have a minimum of one primary pedestrian entrance on the pedestrian passage.

Build-to Zone

- The Build-to Zone is the specified depth along a property's street frontage(s) in which the required minimum façade width must be located. The depth is Subdistrict and Street Type specific.
- Depending on site conditions the front of the Build-to Zone may begin at different locations.
 - » When the existing sidewalk meets the Major and Collector Street Plan standards for sidewalk width, the Build-to Zone begins at the back of the sidewalk/property line.
 - » When the existing sidewalk does not meet the Major and Collector Street Plan standards for sidewalk width, the sidewalk shall be widened on site and the Build-to Zone begins at the back of the new sidewalk.
 - » When utility or pedestrian easements exist along the street frontage of a property the Build-to Zone shall begin at the back of the easement.
 - » When buildings front an Open Space the Build-to Zone shall begin at the back of the Open Space.
- Attachments
 - » Structures, including porches, stoops, and balconies shall not encroach beyond the front of the Build-to Zone.
 - » Elements such as stairs, awnings, and landscaping may encroach beyond the front of the Build-to Zone. Any encroachments into the right-of-way must follow the Mandatory Referral process.
- Entrances
 - » All buildings shall have at least one pedestrian entrance on the Principal Building Frontage. This may be access to a lobby shared by individual tenants.

Section IV: General Standards

Lots and Frontages

- » Corner entrances are appropriate on corner lots.
- Glazing
 - » All street level exterior windows must be clear and fully transparent.
 - » Modifications may be permitted insofar as it is determined that tinting does not substantially diminish the effect of the building wall or the pedestrian character of the street.
- Vehicular Access
 - » When calculating the minimum façade width, access to structured parking shall be counted as part of the required façade width, and access to surface parking shall not be counted part of the required façade width. That is, access to surface parking is allowed in the “remaining” area, after the façade width requirement has been met. Surface parking is not allowed in the “remaining” area.

Active Use

- An active ground floor use requirement shall mean a habitable space occupied by retail, office, institutional, or lobby uses, specifically excluding parking and mechanical uses. Active uses are those programmed spaces that generate pedestrian street activity and interaction. Residential units, short term rental property units, and hotel units are also specifically excluded on the ground floor of all Primary streets. Hallways, storage rooms, fitness centers, and other ancillary spaces are not considered active uses.
- An active use is required on the ground floor of all Primary streets, Secondary streets, Open Space and pedestrian passages. An active use is encouraged on Tertiary streets, particularly if the that street is the only public street frontage.
- Where a building fronts two streets, pedestrian passageways, bridges open spaces, or a combination thereof, on the same vertical plane, the frontage standards shall be applicable to both elevations, except that measurements of height shall be taken from the higher elevation. Alternatives may be reviewed by minor modification.
- The term “active use” and “building liner” are synonymous.

Materials

- All façade materials, exclusive of clear fenestration, shall be high quality and selected from the following list: masonry, masonry panels, textured metal, metal paneling, precast concrete, precast concrete panel, fiber cement panel, fiber cement siding, spandrel glass (on upper stories only), or materials substantially similar in form and function. This requirement applies to any façade visible from a public street, open space, or interstate in all subdistricts.
- Alternative façade material may be used if determined to be appropriate by the Planning Staff. Any determination made by the Planning Staff may be appealed to the DTC DRC.
- Modifications may be permitted insofar as it is determined that these materials are necessary to further an established, overriding policy goal and will not significantly diminish the pedestrian experience.

Auto-oriented canopies and awnings

- Auto-oriented canopies and awnings, for uses such as drive-thrus and gas station pumps, may be attached to a building according to the following:
 - » The building shall comply with all Frontage standards.
 - » The canopy and/or awning shall be lower in height than the primary building.
 - » The setback of the canopy and/or awning shall be a minimum of 15 feet from the back of the Build-to Zone.
- Exteriors
 - » Any new roof or complete resurfacing of an existing room must use a roofing material having an SRI of 29 or greater for room slopes greater than 2:12 or SRI of 78 for slopes less than or equal to 2:12.

Section IV: General Standards

Lots and Frontages: Specific to Storefront Frontage

The Storefront Frontage has a limited Build-to Zone that is close to the street, with building entrances accessible at sidewalk grade. The Storefront Frontage has substantial glazing on the facade at ground level, space for pedestrian-oriented signage, awnings, retail display, and other design features conducive with creating an active commercial streetscape.

The Storefront Frontage is commonly used for general commercial, office, retail, restaurant, lobby, etc.



Section IV: General Standards

Lots and Frontages: Specific to Storefront Frontage

STOREFRONT FRONTAGE

A	Max. sill height	3 ft
B	Min. ground floor height	14 ft from grade
C	Min. upper floor(s) height	10 ft floor to floor
D	Min. ground floor glazing	Principal Frontage 60% from grade to 14 ft Minor Frontage 40 % from grade to 14 ft
E	Min. upper floor(s) openings	25% from floor to floor

NOTES

Where Storefront frontage is allowed, modifications may be given to allow for a Storefront arcade. All Storefront Frontage standards shall be met on the facade behind the arcade.

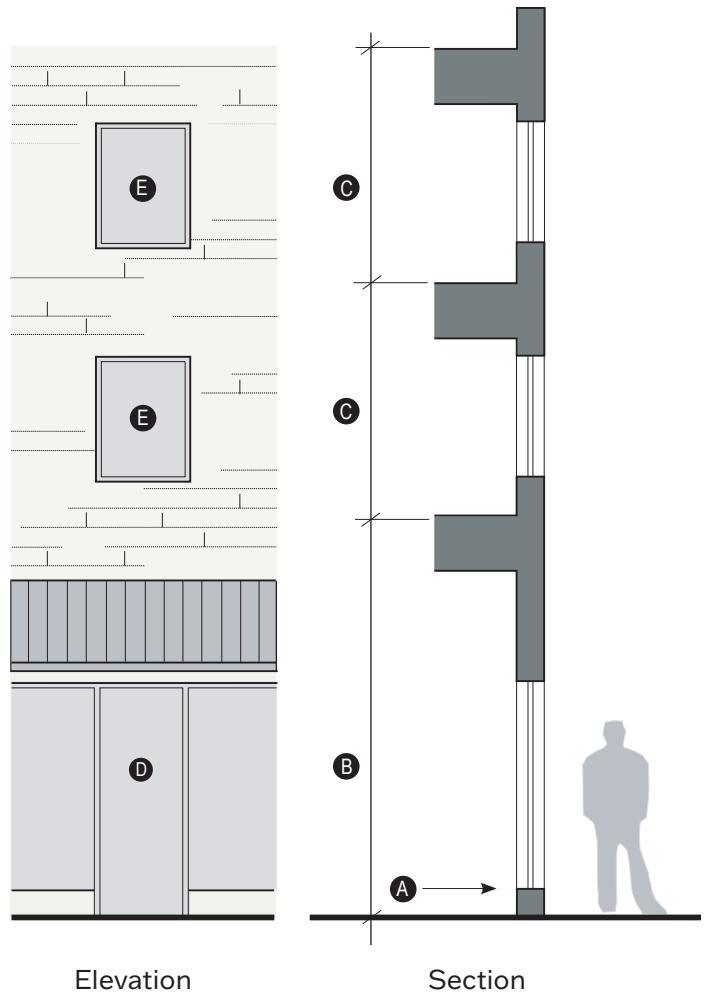

Section IV: General Standards

Lots and Frontages: Specific to Stoop Frontage

The Stoop Frontage has a limited to moderate Build-to Zone with the first floor elevated from the sidewalk grade. This frontage type utilizes a stoop - a small landing connecting a building entrance to the sidewalk by a stair or ramp - to transition from the public sidewalk or open space into the building.

Stoops are generally provided externally, but may be provided internally as necessitated for ADA compliance.

The Stoop Frontage is generally used for residential and live-work buildings, but may be appropriate for other uses.

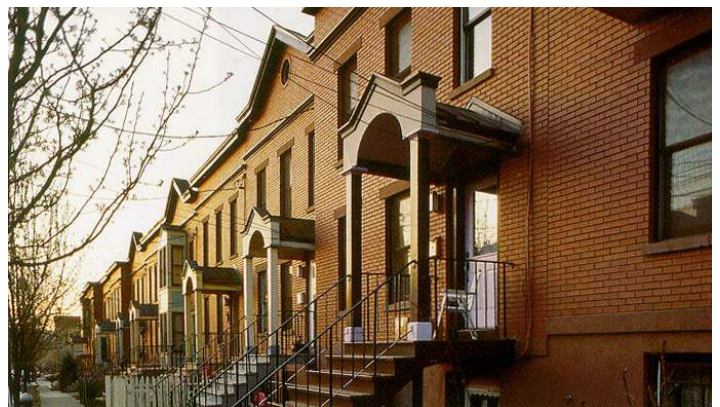

Section IV: General Standards

Lots and Frontages: Specific to Stoop Frontage

STOOP FRONTAGE

A	First floor elevation	
	Min.	18" from grade
	Max.	5 ft from grade
B	Min. ground floor openings	30% floor to floor
C	Min. upper floor(s) openings	25% from floor to floor
Stoop		
D	Min. stoop width	5 ft
E	Stoops may not extend beyond the front of the Build-to Zone.	
F	Steps may extend beyond Build-to Zone, but may not encroach into the public Right-of-Way.	

NOTES

Greater first floor elevation allowed by modification for:

- Property with significant elevation change across the site at the street frontage.
- Development that incorporates below grade basement floors that are accessible from the exterior of the building.

Transition to first floor elevation may be accommodated on the interior of the building to allow for compliance with ADA accessibility requirements.

Entries shall not be recessed more than 4 feet from the facade of the building.

Doors shall face the street.

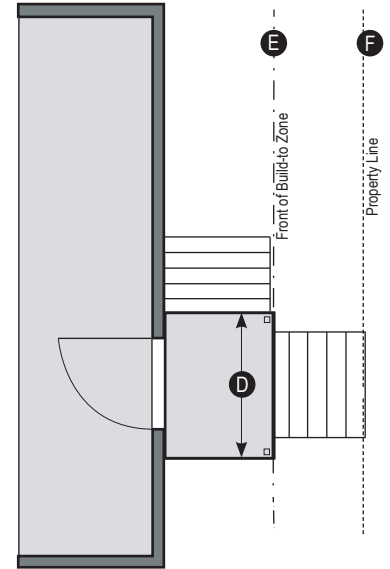

Plan

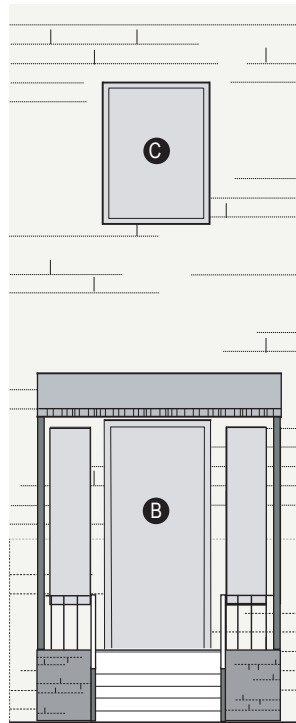

Elevation

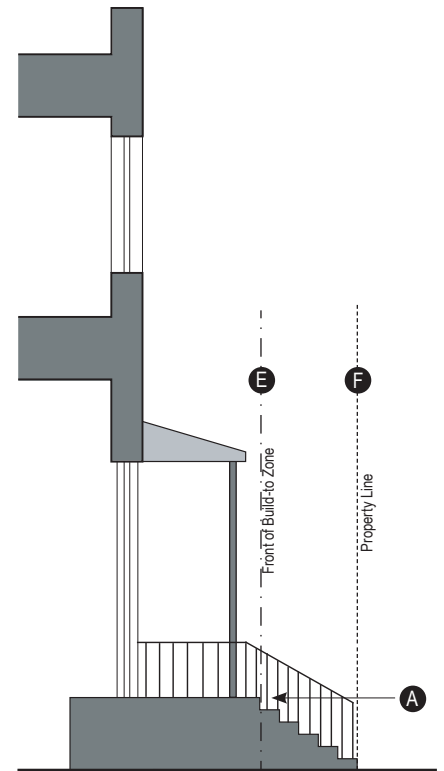

Section

Section IV: General Standards

Lots and Frontages: Specific to Porch Frontage

The Porch Frontage has a moderate Build-to Zone with the first floor elevated from the sidewalk grade. The Porch Frontage utilizes a porch - an open air room appended to the mass of a building with floor and roof but no walls on at least two sides - to transition from the public sidewalk or open space into the building.

The Porch Frontage is primarily used for residential buildings.



Section IV: General Standards

Lots and Frontages: Specific to Porch Frontage

PORCH FRONTAGE

A	First floor elevation	
	Min.	18" from grade
	Max.	5 ft from grade
B	Min. ground floor openings	30% floor to floor
C	Min. upper floor(s) openings	25% from floor to floor
Porch		
D	Min. porch depth	5 ft
E	Stoops may not extend beyond the front of the Build-to Zone.	
F	Steps may extend beyond Build-to Zone, but may not encroach into the public Right-of-Way.	

NOTES

Greater first floor elevation allowed by modification for:

- Property with significant elevation change across the site at the street frontage.
- Development that incorporates below grade basement floors that are accessible from the exterior of the building.

Transition to first floor elevation may be accommodated on the interior of the building to allow for compliance with ADA accessibility requirements.

Entries shall not be recessed more than 4 feet from the facade of the building.

Doors shall face the street.

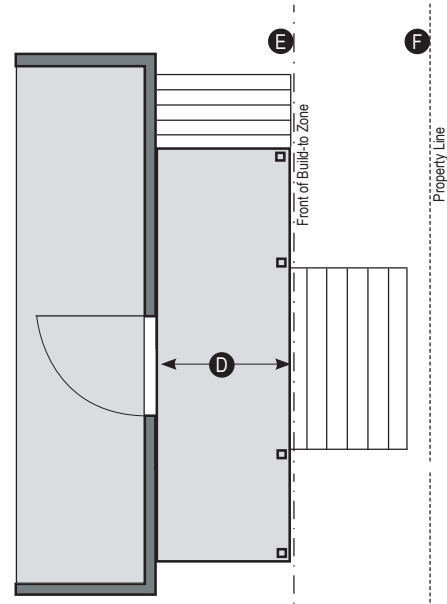

Plan

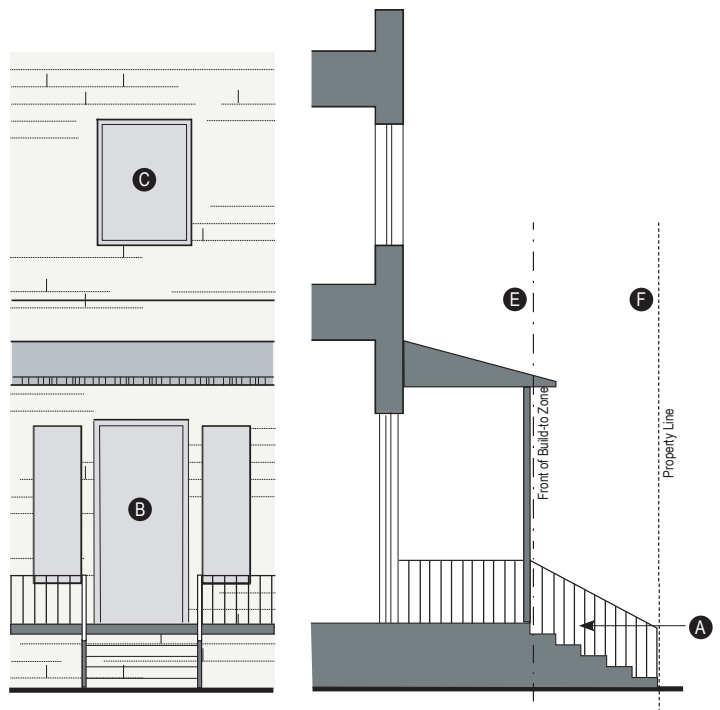

Elevation

Section

Section IV: General Standards

Lots and Frontages: Specific to Industrial Frontage

The Industrial Frontage shall be used to adapt existing buildings to the standards of the DTC and for new construction of buildings intended for industrial uses. The Industrial Frontage shall be allowed only in specified subdistricts on specified streets and shall be prohibited on Primary Streets.

The Industrial Frontage mitigates the negative impact of the “blank wall” on the street by requiring the Build-to Zone to be entirely landscaped with drought-resistant plantings. All landscaping shall be in a functioning bioswale, or irrigated using drip irrigation or sub-surface irrigation. If drought-tolerant species are used, no irrigation is required.

A primary pedestrian entrance is required on the Principle Facade.

Associated vehicular entrances shall comply with the Parking and Access and Mechanical, Screening and Loading standards.

Section IV: General Standards

Lots and Frontages: Specific to Industrial Frontage

INDUSTRIAL FRONTAGE

A	Front door	Required on Principle Facade
B	Min. Building Height	25 ft from grade
C	Build-to Zone	5-10 ft
D	Landscaping	Entire Build-to Zone shall be landscaped with drought resistant species; in a bioswale or irrigated
E	Min. landscaping height	2'-6"

NOTES

Industrial Frontage is prohibited on Primary streets. A building intended for an industrial use, with frontage on a Primary street shall comply with the standards of another frontage type on the Primary street.

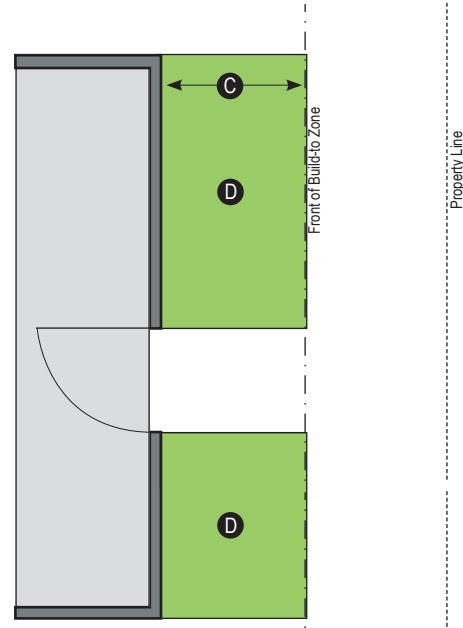

Plan

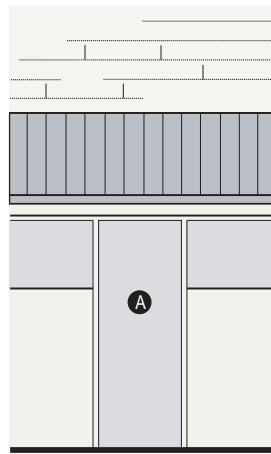

Elevation

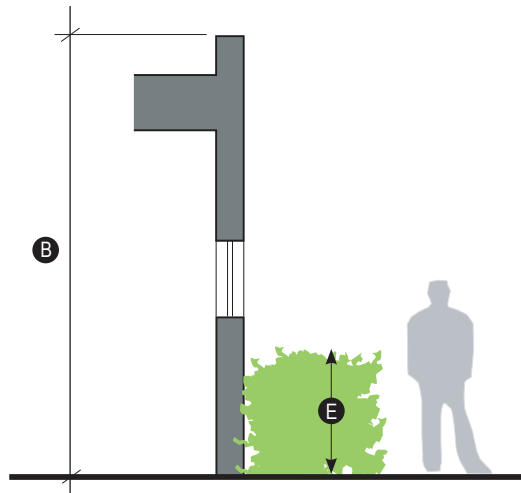

Section

Section IV: General Standards

Lots and Frontages: Specific to Civic Frontage

Civic buildings are designed and constructed for community use or benefit by governmental, cultural, educational, public welfare, or religious organizations. Civic buildings are inherently unique structures that present opportunities for unusual and iconic design within the urban fabric. Civic buildings should be designed with prominence and monumentality.

A Civic building shall be oriented to streets and public spaces and follow the intent of the particular subdistrict in which it is located with regard to pedestrian orientation, massing, and articulation.

Key architectural features should act as community focal points. Where possible, street axes should be terminated by the primary building form or architectural feature. Towers, spires, and other vertical forms are encouraged.

Civic buildings may include the following: community buildings, libraries, post offices, schools, religious institutions, publicly owned recreational facilities, museums, performing arts buildings, and municipal buildings.

Civic buildings shall be reviewed by minor modification.



Section IV: General Standards

Canopies and Awnings

CANOPIES

A Clearance	
Minimum from sidewalk	8'
Minimum with ROW encroachment	14'
Maximum	25'
B Maximum projection	within 2' of curb
C Maximum canopy height	4'

NOTES

Canopies shall be permitted only over pedestrian and vehicular building entrances, and shall not be permitted above windows. Canopies shall be constructed as a roof-like structure. Fabrics and non-rigid plastic are prohibited.

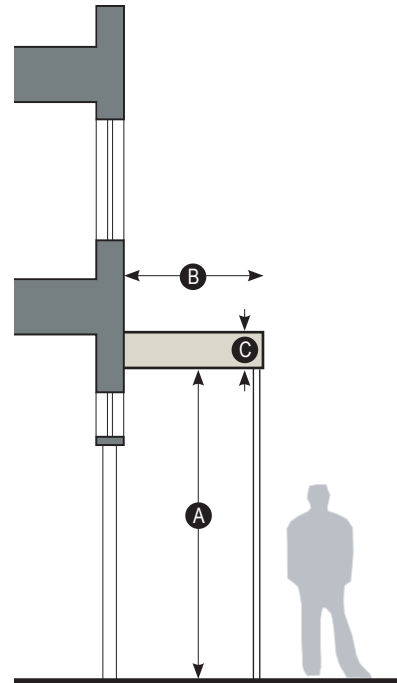

Section

AWNINGS

A Clearance	
Minimum from sidewalk	8'
Minimum with ROW encroachment	14'
B Maximum projection	
First floor	4' from facade
Upper floors	2' from facade
C Maximum awning height	5'

See the Lots and Frontages section for details on auto-oriented canopies and awnings.

Encroachments in the public right-of-way must meet Metropolitan Government's current clearance standards and be approved under the mandatory referral process prior to installation.

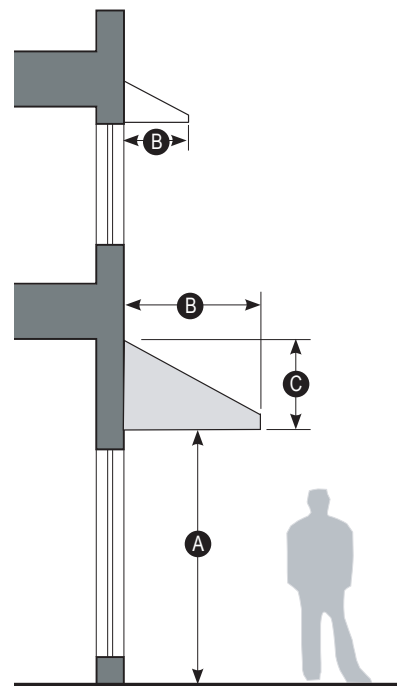

Section

Section IV: General Standards

Parking and Access: General

Parking Requirements

- No parking is required within the boundary of the DTC.

Parking and Access General Standards

- In addition to the Parking and Access standards of the DTC the following shall apply:
 - » 17.20.050 Handicapped parking, 17.20.060 Parking area design standards, and 17.20.130 Loading space requirements.
- When alleys are present, vehicular access from alleys is preferred. Access from public streets shall be considered in the following order: Other Streets, Tertiary Streets, Secondary Streets and then Primary Streets as approved by Metro departments. Reviewers shall consider the public safety, street character, and pedestrian experience.
- Vehicular / Pedestrian Conflict
 - » Where driveways to parking facilities or drop-off areas cross the Sidewalk Corridor, priority shall be given to the pedestrian realm and the following design elements shall be required:
 - » The DTC and MCSP sidewalks and tree planting standards shall be maintained for any pedestrian islands created.
 - » Bollards or other protective device shall be used to separate pedestrian and vehicular areas.
 - » Distinction between vehicular lane and pedestrian areas shall be indicated through changes in grade, color, texture and/or material.
- To reduce stormwater fees and impact, utilize Low Impact Development strategies published in Metro Water Services Stormwater BMPs for hardscaping, including parking and drive lanes.

EV Parking Standards

- EVSE-Installed parking spaces are reserved for EVs and provide drivers the opportunity to charge their electric vehicle using EV charging stations rated at a minimum of 32amp 7.2kW. These spaces should be installed per the requirements of the National Electrical Code (NFPA 70) as adopted and amended by the State of Tennessee.
- EV-Capable parking spaces prepare for future Electric Vehicle Supply Equipment (EVSE) installation by providing dedicated electrical capacity in the service panel (40amp breaker for every two EV-Capable spaces). These spaces do not require wiring to the space or a receptacle.
- Charging equipment must be mounted on the wall or on a structure at the end of the EV parking space provided.
- No charging devices may be placed within the dimensions of the space, on the sides, or entrance to a space.
- When cords and connectors are not in use, retraction devices or locations for storage shall be located sufficiently above the pedestrian surface and the parking lot as to reduce conflicts with pedestrians and vehicle maneuvering.
- Cords, cables, and connector equipment shall not extend across the path of travel in any sidewalk or walkway.
- All EVSE-Installed parking spaces shall be signed as “Reserved for Electric Vehicle Charging”

Section IV: General Standards

Parking and Access: Specific to Structured Parking

Vehicular Access

- Vehicular openings to parking structures shall not exceed thirty-five feet in width.
- Vehicular openings shall have a minimum spacing of thirty-five feet.

Pedestrian Access

- All parking structures with parking available to the public shall have a clearly marked pedestrian entrance, separate from vehicular access, on street frontages. A publicly accessible building lobby may meet this requirement.

Location and Lining

- On the ground level, parking structures shall be located behind a liner building with an active use that is a minimum of fifteen feet deep.
- Upper level habitable liners are encouraged on all streets and are required on James Robertson Parkway and within the East Bank subdistrict. Underground parking is encouraged on all projects but is required on certain sites. See subdistrict standards for details.
- Upper level facade treatments /cladding is required on all public street frontages, including any facades visible from the Interstates. Facade treatments shall integrate or complement the architectural characteristics of the habitable portion of the building and the surrounding built context. Openings for natural ventilation are permissible when integrated into the facade design. Landscape buffering may be considered as an alternative at appropriate locations, such as Interstate frontages.
- All underground parking shall not be visible from the surface of the earth. Underground parking that is completely below grade may extend beyond the façade of the building. Underground parking may not encroach into the right-of-way.

Quantity

- The number of stories of structured parking without upper level habitable liners on all public street frontages and open spaces shall not exceed the number of levels of underground parking.



Appropriate upper level facade treatment with full cladding



Appropriate upper level facade treatment with natural ventilation integrated into the facade design

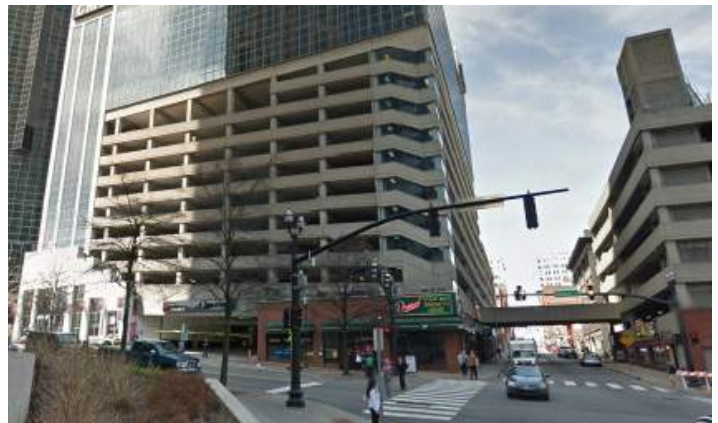

Inappropriate upper level facade treatment

Section IV: General Standards

Parking and Access: Specific to Surface Parking

General Standards for Surface Parking

Parking area screening and landscaping standards shall apply to all surface parking lots including, but not limited to, public and private parking facilities, driveways and access aisles, the outdoor display of automobiles and other vehicles that are for sale or lease.

Perimeter Screening Standards for Surface Parking

Parking areas adjacent to public streets and open space shall be separated from the edge of the right-of-way and/or property line by a perimeter landscape strip a minimum of five feet in width which shall be landscaped per the standards of this section.

All perimeter landscape strips adjacent to public streets and open space shall include a fence or wall in accordance with the Fence and Wall Standards.

Parking areas shall be separated from adjacent side lot lines by a perimeter landscape strip a minimum of 5 feet in width, which shall be landscaped per the standards of this section.

A two and one-half foot landscape strip may be provided if the required trees are to be planted in tree islands located adjacent to the property line.

Two adjacent properties may share equally in the establishment of a seven-foot (minimum) planting strip along the common property line. In instances where the common perimeter planting strip is part of a plan for shared access, each owner may count the respective area contributed toward that common planting strip toward the interior planting area requirements for the lot.

Berms are not permitted in any landscape strips.

Interior Planting Requirements

Parking areas shall be landscaped in accordance with the interior planting requirements of Title 17.24.160.

Parking areas with less than twelve thousand square feet in total area shall be exempt from the interior and side lot line planting requirements.

Landscape Materials

Perimeter landscape strips along public streets, open space and side lot lines.

Trees shall be installed at a rate of one tree for every thirty feet of frontage. Spacing may be adjusted with the approval of the Urban Forester based upon tree species, the presence of utilities, and the dimensions of the planting strip.

Evergreen shrubs and trees shall be installed at appropriate spacing to fully screen vehicles to a minimum height of two and one-half feet.

Plantings within fifteen feet of driveways or street intersections shall be maintained to a maximum height of two and one-half feet.

Plantings shall not obstruct views onto site as to impede the security of users.

Tree and shrub species shall be chosen from the Urban Forestry Recommended and Prohibited Tree and Shrub List or an alternative species deemed appropriate by the Urban Forester.

At planting, trees shall be a minimum of six feet in height and two caliper inches.

All landscaping shall be in a functioning bioswale, or irrigated using drip irrigation or sub-surface irrigation. If drought-tolerant species are used, no irrigation is required.

At planting, all landscaping shall meet the standards for size, form and quality set out in the American Standard for Nursery Stock (ANSI Z60.1, latest edition).

All nursery stock shall be vigorous, healthy and free of diseases or infestation.

Section IV: General Standards

Mechanical, Service, and Loading

Applicability

The following elements shall be shielded from view from adjacent public streets, pedestrian corridors, and open spaces.

- Refuse collection, dumpsters, recycling bins, and refuse handling areas that accommodate a dumpster or five or more trash or recycling cans.
- Building or ground-mounted mechanical equipment, including, but not limited to, transformers, backflow preventors, telephone risers, equipment cabinets, generators, or similar devices.
- Mechanical equipment on roofs.
- Air conditioning or similar HVAC equipment.
- Loading docks, berths, or similar spaces including, but not limited to, service entrances and maintenance areas.
- Outdoor storage of materials, equipment, and vehicles.

Location and Access

- Applicable site elements shall be located along the alley, along an interior property line, or internal to the property.
- Service elements, such as loading docks, should not be accessible from Primary streets, unless a Primary street is the only frontage.
- Trash and recycling collection shall be located below grade or internalized within blocks. Direct access to street frontage is prohibited.
- Where access to loading areas and service elements cross the Sidewalk Corridor, priority shall be given to the pedestrian realm and the following design elements shall be required:
 - » The DTC and MCSP sidewalks and tree planting standards shall be maintained for any pedestrian islands created.
 - » Bollards or other protective device shall be used to separate pedestrian and vehicular areas.
 - » Distinction between vehicular lane and pedestrian areas shall be indicated through changes in grade, color, texture and/or material.

Screening Standards

- Applicable site elements shall be fully screened at all times, including immediately following planting if vegetative materials are to be used.

- Refuse collection and refuse handling areas shall be screened by a walled enclosure with gates in accordance with the Fence and Wall Standards of the DTC.

Screening Methods

- Vegetative Materials:
 - » Vegetative materials shall be planted in two rows in staggered fashion.
 - » All trees shall be evergreen with a minimum height at time of planting of at least six feet above the root ball.
 - » All shrubs shall be evergreen with the minimum height and spacing necessary to fully screen the item intended for screening (but no less than thirty inches in height) at the time of planting.
 - » Vegetative material shall be located immediately adjacent to the element being screened in a planting area a minimum of four feet wide.
- Fencing and Walls
 - » Screening is permitted through the use of a fence or wall constructed in accordance with the Fences and Walls Standards of the DTC.
- Parapet Walls
 - » Parapet walls or other techniques included as an integral part of the building design shall be used to totally screen any rooftop mechanical equipment from view from adjacent public rights-of-way or open space.
- Integrated Building Elements or Features
 - » Building design or other structural features (e.g., knee walls, alcoves, wing walls, roof extensions, etc.) may also be used to fully or partially enclose site features required to be screened.
- Alternative Screening Methods
 - » Alternative screening methods or materials that are not listed may be used following approval by the Planning Commission or its designee, provided that they are determined to be comparable to screening methods described in this subsection.

**In order to properly locate and screen mechanical equipment, approval may be required from applicable Metro departments and agencies.

Section IV: General Standards

Fences and Walls

Location

- Permitted Locations: Fences and walls constructed in accordance with the standards in this section may be constructed within:
 - » The Build-to Zone.
 - » A utility easement only through the express written consent from the utility or entity holding the easement.
 - » A required landscape area, Tree Protection Zone, or open space.
- Prohibited Locations: No fence or wall shall be installed that:
 - » Encroaches into a right-of-way (without approval through the Mandatory Referral process).
 - » Blocks or diverts a natural drainage flow on to or off of any other land.
 - » Compromises safety by blocking vision at street intersections or obstructs the visibility of vehicles entering or leaving driveways or alleys.
 - » Blocks access to any above ground or pad-mounted electrical transformer, equipment vault, fire hydrant or similar device.

Appearance

- All fences shall be installed so that the finished side shall face outward; all bracing shall be on the inside of the fence.
- Fences and walls shall be constructed of any combination of brick, stone, masonry materials, treated wood posts and planks, rot-resistant wood, or metal. Chain link fencing shall be coated with dark green or black vinyl when visible from a public street or open space (excluding alleys).
- Chain-link fences are prohibited within the Build-to Zone.
- Razor wire is prohibited within the Build-to Zone.
- Fences and walls used to screen refuse areas shall be opaque and include gates that prohibit unauthorized users to access the area.

Standards by function and location

- Fences and walls within the Build-to Zone shall not exceed four feet in height.
 - » Modifications may be made in order to properly secure playgrounds and parks.
 - » The height of fences and walls along a sidewalk shall be measure from sidewalk grade.
- Fences and walls within the Build-to Zone that are greater than three feet high shall be a minimum of thirty percent transparent to allow visibility into the property.
- Fences and walls used to screen parking shall be a minimum of two and one-half feet above the grade of the parking lot.
 - » When a fence or wall is combined with plantings the majority of the plantings shall be between the right-of-way and the fence or wall.
- Fences and walls used to screen mechanical, loading and refuse elements shall be a minimum of two feet taller than the element being screened.
- All other fences and walls shall have a maximum height of ten feet measured from grade.
- Fences surrounding athletic fields and courts may exceed the previous height limitations.

This page left intentionally blank

Section IV: General Standards

Outdoor Space

Introduction

NashvilleNext envisions enjoyable outdoor spaces as vital elements of Downtown’s urban neighborhoods, integral to livability, and accessible within one-quarter mile to any Downtown resident. The Downtown Code (DTC) incorporates the goals of NashvilleNext and promotes a range of outdoor space types – that can form a cohesive network that serves the diverse needs of residents and visitors, while bolstering environmental resiliency and a vibrant public realm. As functional infrastructure, outdoor spaces should link adjacent greenways, parks, play areas, plazas, natural areas, as well as passive and recreational facilities to form an expansive and universally accessible public realm.

All proposed outdoor spaces shall comply with this section, whether publicly- or privately-owned.

Metro-Owned Outdoor Spaces

Metro Parks and Greenways are a critical and valued component of Downtown’s public realm, operated and maintained by the Metro Parks Department. In addition, some alleys and shared streets may function as outdoor spaces, for a specific event or throughout the year, though they are located within Metro rights-of-way (ROW). These outdoor spaces shall follow the standards set out by their respective governing departments with consideration for applicable easements and operating agreements.

Privately-Owned Public Spaces (POPS)

Privately-owned public spaces (POPS) are publicly accessible and welcoming outdoor spaces owned, operated, and maintained by a private entity, on privately-owned property. POPS proposed within the DTC shall meet the design and operations standards set forth in “Outdoor Space General Design Standards” (page 90). POPS that meet pertinent eligibility requirements and design criteria may be eligible for the POPS Bonus Option within the DTC Bonus Height program (page 100).

As a vital and welcoming element of the DTC’s public realm, POPS shall:

1. Be accessible and enjoyable for all users regardless of ability, by complying with applicable code standards for access for persons with disabilities.
2. Provide clear signage at each street frontage that describes the space as publicly accessible and outlines the terms of use for the space.
3. Be generally accessible during daylight hours, with minimal closures, throughout the year.

Overview

Any proposed outdoor space in the DTC shall be reviewed for how they address four fundamental design components (page 90-96):

- | | |
|------------------------------------|-----------------------------------|
| A Site Context and Response | C Fixtures and Furnishings |
| B Site Design and Layout | D Materials |

Depending on the outdoor space’s typology (page 89), type-specific requirements may apply (page 97-98).

How to Use this Section

Throughout the rest of this section, *intent*, *requirements*, and *recommendations* are included for outdoor space design and operations standards. *Intent* statements are included to guide applicants, the DRC, and Staff in their interpretations of the section. The *requirements* are mandatory and, as such, are subject to the typical DTC modification procedure for any proposed variance from the standard. *Recommendations* are not mandatory, but are provided as suggestive guidance to demonstrate best practices. Variance from the *recommendations* shall not be subject to the DTC modification process.

Section IV: General Standards

Outdoor Space

Typology

The DTC is comprised of a diverse array of outdoor spaces, categorized by the types listed below. Several typologies have type-specific requirements (page 97-98).

While some types in this list—such as alleys or outdoor dining areas—could be found on private property or within public right-of-way, the standards in this section apply only to private property.

DTC Outdoor Space Types without type-specific requirements	DTC Outdoor Space Types with type-specific requirements (page 97-98)
<ul style="list-style-type: none"> • Court or Courtyard: an enclosed outdoor space adjacent to and associated with a neighborhood building. • Paseo (Passage): a narrow, pedestrian-only connection between buildings, which may be roofed over and/or lined by active uses. • Play Structure: a play fixture or facility designed for active use for all age groups, which may or may not be enclosed. • Plaza: a paved public space intended to support civic, religious, or commercial gatherings, accommodating air and light in the urban fabric. • Pocket Park: small, publicly accessible outdoor spaces—usually less than 0.5 acres—typically found in dense urban areas where access to larger parks or green spaces is limited. • Greenway or Shared-Use Path: paved off-road facilities designed for travel by a variety of nonmotorized users, including pedestrians, bicyclists, skaters, joggers, and others. • Other, as deemed appropriate by MPC staff. 	<ul style="list-style-type: none"> • Alley (private only): a narrow access point serving the non-primary frontage of buildings, typically paved to the edges without curbs, designed for either vehicular or pedestrian use. • Dog Park (Dog Run): an outdoor, enclosed space intended to meet the physical needs of dogs in the urban environment. • Green Infrastructure: natural or semi-natural areas designed and managed to deliver ecosystem services such as purifying stormwater, mitigating stormwater runoff, improving air quality, enhancing biodiversity, providing habitat, mitigating the urban heat island effect, offering space for recreation, and assisting in climate mitigation and adaptation. • Outdoor Dining Areas: outdoor spaces designated for the consumption of food or drinks. • Playground: a play area intended for active recreation primarily designed for children. • Splash Pad (Spray Park): a recreation area featuring interactive water elements for play and cooling. • Through Block Plazas: outdoor spaces located midblock that connect two street frontages.

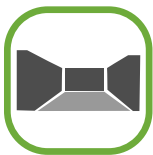

Court or Courtyard



Play Structure

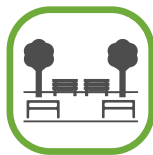

Pocket Park



Alley (Private Only)



Dog Park (Dog Run)



Outdoor Dining Areas



Playground



Paseo (Passage)



Plaza



Greenway or Shared-Use Path



Green Infrastructure



Splash Pad (Spray Park)



Through Block Plazas

Section IV: General Standards

Outdoor Space: Design Standards

A Site Context and Response Design Standards

Outdoor spaces shall intentionally respond to and complement the existing site context and urban fabric, including a sensitive consideration of topographical conditions, slope, aspect, circulation patterns, and surrounding buildings and infrastructure.

- Requirements:
 - » Solar orientation studies shall be provided at summer and winter solstice to ensure both sunny and shaded areas to optimize seasonal comfort.
 - » POPS shall be visible from the primary street frontage or next hierarchical street type.
 - » POPS shall generally be located at the same grade level as adjoining sidewalks and streets. Minor changes in elevation, not to exceed 30 inches above or below the adjacent sidewalk, are permitted. Additional flexibility may be considered for POPS larger than 10,000 square feet.
 - » Sites adjacent to rail corridors or the Interstate shall provide noise buffers. Sight lines for railroads may be maintained.

Outdoor spaces shall improve multimodal connectivity within Downtown.

- Requirements:
 - » Internal paths for circulation are required to connect each of the street frontages on which an outdoor space fronts to building entrances and major design features.
 - » If a site is adjacent to or abuts an existing or planned Metro Park or Greenway, it shall provide an accessible and direct pedestrian connection to that resource. (Refer to Plan to Play for planned Metro Parks and Greenways.)
 - » If a site is within 100 feet of a transit stop, an accessible and direct pedestrian path shall be provided to connect the outdoor space to the transit stop or adjacent sidewalk.

Outdoor spaces shall maximize their relationship to and views of the Cumberland River, where relevant.

- Requirements:
 - » If a sight line to or view of the Cumberland River exists from a proposed site, the sight line shall

be preserved through the orientation of the outdoor space where feasible.

- » If public access to the waterfront is currently provided on a site, it shall be preserved and enhanced.
- Recommendations:
 - » WEDG (Waterfront Edge Design Guidelines) are encouraged for riverfront properties.

Outdoor spaces shall respect historic and culturally significant structures and landmarks, where relevant.

- Requirements:
 - » If a sight line to or view of a nationally or locally designated historic place or landmark exists from a proposed site, the sight line shall be preserved through the orientation of outdoor space where feasible.
 - » If an outdoor space is proposed adjacent to a national or locally designated place or historic landmark, the design shall acknowledge the historic resource using at least one of the following design techniques:
 - ◇ Site design that enhances visual or physical connectivity to the resource
 - ◇ Site layout that complements the resource
 - ◇ Programming that complements the use or character
 - ◇ Best practices for designing in a historical context shall be followed, including utilizing complementary building materials, vegetation, and design styles. Department of Interior Standards shall be used when designing adjacent to historic landmarks.

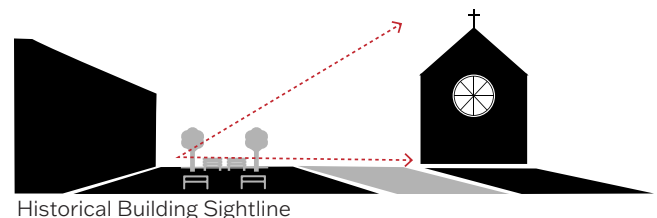

Section IV: General Standards

Outdoor Space: Design Standards

B Site Design and Layout Design Standards

Outdoor spaces shall maximize human comfort, support livability, and advance quality of life.

- Requirements:
 - » A site shall be designed so that occupiable outdoor spaces receive at least partial shade during the summer.
 - » Refuse collection:
 - ◇ Refuse bins shall be placed in visible locations, near seating areas and within 10-20 feet of each entrance or access point.
 - ◇ One refuse bin shall be required for every 1,500 square feet of outdoor space to ensure convenient access throughout the site.
 - ◇ All refuse bins shall be covered.
- Recommendations:
 - » A site should strive to be designed in a way that occupiable outdoor spaces receive sun for at least one hour on a winter day.
 - » Refuse bins should be located throughout the site.

Outdoor spaces shall engender safety and security.

- Requirements:
 - » Provide lighting as specified by section 17.28.100 of the Metro zoning code for safety, visibility and expected nighttime activity.
- Recommendations:
 - » Specify light fixtures that complement the design of the space and enhance the overall ambiance.
 - » Consider solar-powered and energy efficient fixtures, as well as energy-saving features such as timer and motion control.
 - » Minimize short-wavelength (bluish) light.

Outdoor spaces shall encourage gathering, socialization, and active use within public spaces.

- Requirements:
 - » A minimum of half of the seating provided shall be primary seating—i.e. chairs or benches with backs and arm rests. The other half of the seating may be informal seating such as steps,

planters, pedestals, seat walls, etc.

- Recommendations:
 - » In busy pedestrian areas or along expected pedestrian routes seating should be spaced at a rate of one linear foot of seating per 200 feet of outdoor space. In outdoor spaces such as plazas, seating may be placed at one linear foot of seating for every 30 square feet of plaza to ensure easy accessibility and inclusive mobility.
 - » Hostile or unwelcoming architectural elements, such as spikes and the excessive use of bollards, are discouraged.
 - » Provide a range of seating options, including benches with backs and armrests, as well as tables that accommodate wheelchairs.
 - » Pair seating areas with shade, water features, outdoor dining, views, and children’s play areas.
 - » Consider modular designs that can be rearranged to accommodate different activities and events.
 - » Design seating arrangements at a variety of scales and groupings for a range of gatherings, from smaller and informal to larger programmed events.

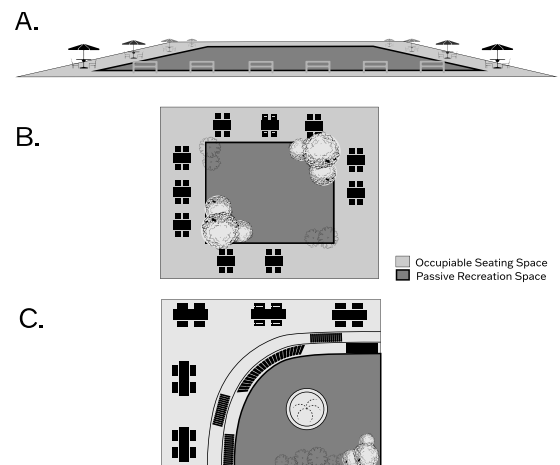

Seating examples for occupiable outdoor space

Section IV: General Standards

Outdoor Space: Design Standards

C Fixtures and Furnishings Design Standards

No single fixture or furnishing in this section is mandatory within the DTC. However, if one from the provided list is proposed, it shall comply with the associated design requirements.

C1 Art Fixtures and Furnishings

Intent:

To enrich the cultural and visual character of a place by showcasing creative works that reflect the community's identity, values, and history, while offering opportunities for reflection, inspiration, and public engagement. Art, including but not limited to sculpture, murals, water features, and environmental artwork are encouraged within or adjacent to outdoor space.

Requirements:

- Art shall not obstruct pedestrian or vehicular circulation patterns or contribute to congestion.
- Art shall be reviewed for potential safety hazards for pedestrians or motorists, including but not limited to, obstructed site lines and creation of potentially adverse distractions or movements.
- Art shall be of an appropriate size and scale for the space in which it is being proposed.
- Art shall be appropriately lit.
- Art shall not interfere with the entrance or egress areas at driveways, bus stops and parking bays.
- Art shall not disrupt curb use activities such as crosswalk ramps, access to benches, loading zones, access to parked vehicles, fire hydrants, traffic signals, and utilities.
- Art shall maintain unobstructed access to above and below ground utilities.
- A declaration of the entity responsible for the ongoing maintenance of the work shall be included in the final site plan for the site.

Recommendations:

- Art should be relevant to the community, reflecting the local culture, history, or community values, ensuring it resonates with users of the space.

- Ensure that art pieces are thoughtfully integrated into the site design— placed and positioned to enhance the space and overall design intent.
- Consider pieces that encourage interaction, such as sculptures that can be touched or sound installations that respond to movement. Art should be damage resistant.

C2 Bicycle Racks and Corrals Fixtures and Furnishings

Intent:

To provide the necessary support for bicycle transportation to and from the site and within the surrounding area.

Requirements:

- Bike parking provided for designated open space may count towards the minimum publicly available spaces required for principle uses located within the UZO per section 17.20.135 of the Metro zoning code.
- Short-term bike parking shall be provided at 0.5 spaces per acre, with a minimum of 4 spaces per open space.
- Required bike parking shall be dispersed among visible and accessible locations including:
 - » along each street fronted by the open space.
 - » within a maximum distance of 50 feet from an entrance
- Bike parking shall be visible from within the Outdoor Space.
- Locate bike racks in well-lit, highly visible areas for security and ease of access.
- Materials shall be selected for high durability, low maintenance, and rust resistance.
- Bike racks shall provide two points of contact (such as an inverted U). Components of rack shall be less than 2" in diameter to allow for locking of bicycle to the frame.
- Bike racks shall be spaced at a minimum 36" to accommodate to bikes between racks.
- When adjacent to a wall, vegetation, or curb, bike racks shall have a minimum clearance to surroundings by 24" minimum.

Section IV: General Standards

Outdoor Space: Design Standards

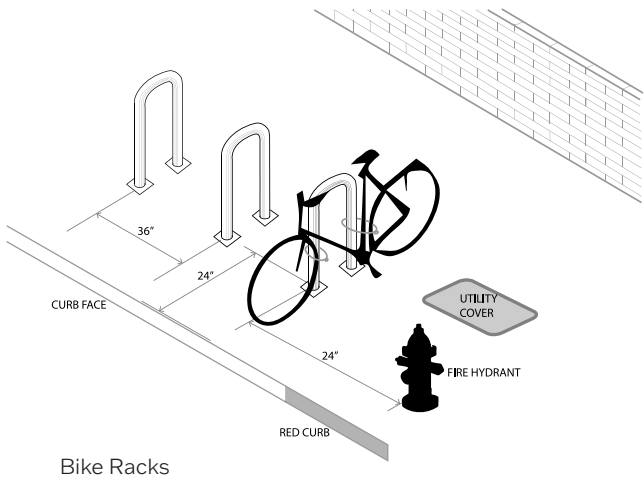

Bike Racks

Recommendations:

- Rack use should be intuitive and recognizable for first-time users. Wayfinding signage accompanying the racks or station is encouraged.
- Racks should be provided at seating areas and at entrances to the space or intersection points with greenways or other walking paths.
- Parking stations should accommodate a variety of bicycle sizes, shapes, and attachments.
- Consider providing lighting for bike racks proposed in a location likely to see use outside of daylight hours or locating racks near existing lighting.
- Racks should be sturdy and well anchored. Security features such as specialty racks, tamper-proof mounting techniques, or active surveillance are encouraged.

C3 Bollards Fixtures and Furnishings

Intent:

To enhance safety, direct circulation by creating a barrier between pedestrian-oriented spaces, cycle paths, and vehicular zones, and to secure vulnerable sites.

Requirements:

- A minimum of 36 inches of clearance to any streetlight pole, traffic signal pole, or other utility pole is required.
- A minimum of 72 inches of clearance to base of any tree without a tree-well is required.
- A minimum of 72 inches of clearance to installed seating is required.
- A minimum of 36 inches of spacing between bollards is required.

Recommendations:

- Explore alternative methods of creating a perimeter around or within a site as a first option, including but not limited to grade or material changes, vegetation, lighting, signage, and sculptural or architectural elements that contribute to the overall design intent.
- Bollards with internal lighting are encouraged.
- Retractable or removable bollards are preferred.

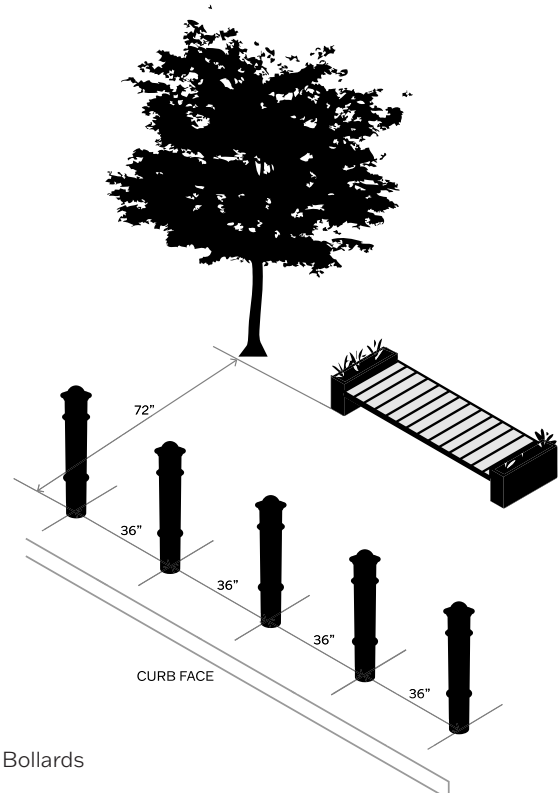

Bollards

Section IV: General Standards

Outdoor Space: Design Standards

C4 Drinking Fountains Fixtures and Furnishings

Intent:

To improve comfort and safety for visitors, especially in warmer weather and for those participating in active recreation or transportation.

Requirements:

- Ensure fountains are ADA-compliant, with options for users of different heights and abilities.

Recommendations:

- Consider fountains that include bottle-filling stations to reduce plastic waste and accommodate modern user needs.
- Position fountains within 3-5 feet of pathways to make them easily accessible.
- Position fountains within 10-20 feet of seating areas to provide convenient access to drinking water without disturbing those seated.
- Position fountains in easily accessible, high-traffic areas, ideally near restrooms, playgrounds, and seating areas.

C5 Shade Structures and Canopies Fixtures and Furnishings

Intent:

To increase comfort and safety of the public realm by providing a place of respite for visitors, especially in warmer months and in areas with little shade.

Requirements:

- Freestanding shade structures shall not be located within the right-of-way or in conflict with circulation paths.
- All portions of the shade structure shall be a minimum of 8 feet from grade to provide vertical clearance.

Recommendations:

- Shade elements can include natural features such as canopy trees, plant foliage, and/ or built structural elements such as awnings, pergolas, etc.
- Position shaded structure to have comfortable spaces along walking pathways, seating areas, waiting areas, and children's play areas, etc.

C6 Steps Fixtures and Furnishings

Intent:

Minimum and maximum step dimensions are specified to ensure that changes in elevation are comfortable, safe, and appropriate to an outdoor space.

Requirements:

- Steps are to have a height between 4 and 6 inches, and a tread depth no less than 15 inches.

Recommendations:

- Landings should be provided at regular intervals.
- Bike channels are recommended for staircases with over four treads.

C7 Water Features Fixtures and Furnishings

Intent:

To enhance the sensory experience of the space, encourage social gathering, and mitigate heat.

Requirements:

- A water feature shall be located where it is highly visible to and usable by the occupants.
- Water features shall be designed to optimize safety—following safe water depth standards, signage best practices, etc.
- Features shall be designed to properly drain and prevent standing or still water.
- Features shall be designed to turn-off during freeze conditions and reduce water-use during droughts.
- When a water feature is specified, outdoor seating shall be provided within 25 feet of the feature.

Recommendations:

- Incorporation of interactive and/or educational water elements are encouraged.
- Features shall be regularly cleaned and treated to prevent algae growth and ensure operations.
- Water features that are usable or visually pleasing when winterized are encouraged.

Section IV: General Standards

Outdoor Space: Design Standards

D **Materials** Design Standards

D1 **Paving and Hardscape** Materials

Intent:

To provide accessible, durable hardscape areas that contribute to the beauty, comfort, and functionality of the public realm.

Requirements:

- Paving materials within pedestrian and movement zones shall meet applicable ADA requirements.
- Paving materials shall have a solar reflectance index (SRI) value of at least 29.
- Pervious paving materials shall meet the Metro Stormwater LID standards.

Recommendations:

- Pervious paving materials such as permeable concrete, permeable pavers, decomposed granite, pea gravel, crushed stone, mulch, flexi-pave, and turf-cells are encouraged.
- Use of paving comprised of at least 15% recycled content is encouraged.
- Pervious pavements must account for the native soil infiltration rate, void space, and result in the desired storage and decreased runoff volume.
- The placement of pervious paver systems shall not obstruct the growth of trees.
- Pavement patterns, scouring, coloring, and texture should help to define the function and travel paths of outdoor spaces.

D2 **Vegetation** Materials

Intent:

To support livability, bolster environmental performance, provide shade, and enhance the character of the public realm.

Requirements (Trees and Shrubs):

- Metro's Urban Forestry and TDU requirements shall be followed.
- A minimum of fifteen percent of trees and shrubs shall be of species native to the Southeastern USA Plains Ecoregion (US EPA Level II, 8.3) and their variants and cultivars (e.g. Dura Heat® River Birch).
- Proposals with ten or more trees shall incorporate minimum of two genera (genus).
- Non-natives shall be of hardy, climate-adapted species that are low-maintenance and urban tolerant.
- Trees shall be spaced according to their mature size and to provide shade to occupiable areas during the warm season months (May-September) at maturity.
- Automatic irrigation systems shall be provided.

Recommendations (Trees and Shrubs):

- Strategically plant trees to provide shade, reduce heat islands, and enhance the space's visual appeal.
- Consider sightlines and ensure trees don't obstruct important views.
- Implement a regular maintenance plan that includes pruning, watering, and monitoring for pests or disease.
- Habitat supportive tree selection is encouraged.
- Enhancing the space's visual appeal by appropriate tree selection is encouraged.

Requirements (Herbaceous and Non-Woody Plants):

- Metro's Urban Forestry and TDU requirements shall be followed.
- A minimum of ten percent of herbaceous plants shall be species native to the Southeastern USA Plains Ecoregion (US EPA Level II, 8.3), their variants or cultivars—e.g. Echinacea purpurea 'White Swan' or Panicum virgatum 'Shenandoah'.
- Plants shall be spaced according to their mature size (typically 12-24 inches for perennials and grasses) to achieve 90 percent or more surface coverage after establishment.
- Automatic irrigation systems shall be provided.

Section IV: General Standards

Outdoor Space: Design Standards

Recommendations (Herbaceous and Non-Woody Plants):

- Landscaping should enhance the visual appeal of the space, providing a mix of textures, colors, and heights.
- Planting designs should consider multi-season interest.
- Lush planting is encouraged to achieve maximum coverage in two to three years.
- Habitat supportive species are encouraged.

D3 Soils Materials

Intent:

To create a beautiful, sustainable, and functional public realm and ensure the health and longevity of the urban forest.

Requirements:

- Soil depth shall be between 3 and 3.5 feet. Soil depth deeper than 4 feet shall not count towards soil volume.
- Large and medium canopy trees shall be provided with a minimum of 480 cubic feet of soil per tree and a minimum 25 square foot permeable surface area around the trunk (mulch, decomposed granite, tree grate, etc.).
- Understory trees shall be provided with a minimum 240 cubic feet of soil per tree and a minimum 16 square foot permeable surface area around the trunk.
- Tree grates, when proposed, shall be modular and allow for removal as the tree grows in circumference.

Recommendations:

- Soils should be crumbly and loose textured with enough compactness to prevent settlement but loose enough to allow drainage, tree root growth, and infiltration when located within a green infrastructure project. A loam mixture of 40% sand, 40% silt, and 20% clay is recommended.
- Soils specifications located within Low Impact Design or Green Infrastructure projects should provide a medium for plantings to flourish and prevent sedimentation.
- Tree cells are encouraged to maximize soil volumes and urban tree health.

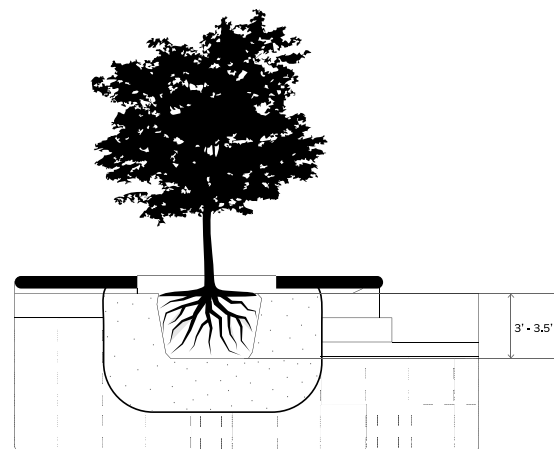

Soil Depth

Section IV: General Standards

Outdoor Space: Operations and Maintenance

E Type Specific Requirements Operations and Maintenance

Property owners are responsible for the timely operations and continued maintenance of all POPS and respective component including fixtures, furnishings, and materials. All outdoor spaces shall be operated and maintained so that they are safe, secure, clean, functional, welcoming, and accessible throughout the year.

E1 Dog Parks and Dog Runs Type-Specific Requirements

Intent:

To enhance livability by providing safe, enclosed recreation spaces for dogs in our urban environment.

Requirements:

- Dog parks entrances shall not be located immediately adjacent to arterials or major roads. Exceptions may be permitted for spaces proposing a landscape buffer or generous setback from the road or corridor, subject to staff discretion.
- Signs describing terms of use shall be placed at the entrance of all dog parks.
- Dog parks shall be enclosed and lit to ensure safety and security.
- Dog parks shall be equipped with double gates for safe ingress and egress.
- Dog parks shall provide waste bags and waste receptacles near all gates and entry points.
- Dog parks shall provide shade and seating.
- Dog parks shall provide water fountains for dogs.
- Dog parks shall provide a hose bib for maintenance and washing.

E2 Green Infrastructure Type-Specific Requirements

Intent:

Green infrastructure shall be designed to enhance stormwater management, bolster environmental resiliency, and contribute to the beauty and character of the public realm.

Requirements:

- Green infrastructure shall comply with Metro Water Services Low Impact Development Standards.
- Green infrastructure areas shall be planted to ensure 90% coverage of the surface area at maturity.
- Green infrastructure shall be composed of a diverse matrix of flood tolerant plants, including those native to the Southeastern USA Plains Level II Ecoregion.
- Green infrastructure shall not be sited to conflict with other programmatic elements or obstruct pedestrian pathways.

Recommendations:

- Bioswales shall be meticulously maintained: regularly remove debris and sediment, manage invasive species, and monitor the health of plantings.
- Ensure that the chosen plantings add to texture and habitat value of the surrounding environment.
- Educational signage is encouraged.

E3 Playgrounds Type-Specific Requirements

Intent:

Play spaces create safe, inclusive, and stimulating environments that promote physical activity, social interaction, and cognitive development for children of all ages and abilities.

Requirements:

- Playgrounds shall provide shade and seating with clear site lines and within 15 feet of play areas for adult supervision of children.
- Playgrounds shall adhere to standards ensuring safety and accessibility, such as the provision of soft surfaces in fall zones.
- Playgrounds shall provide accessible water fountains.

Recommendations:

- These areas should be thoughtfully planned for year-round enjoyment, incorporating shade,

Section IV: General Standards

Outdoor Space: Design Standards

protection from wind, by using materials that suit seasonal changes, all while harmonizing with the surrounding built environment.

- Include elements that cater to a range of ages and abilities, ensuring ADA compliance.
- Establish a regular cleaning and inspection schedule to ensure the area remains safe and inviting.
- Interactivity: Provide a mix of physical and sensory play opportunities, such as climbing structures, water play, and musical elements.
- Provide separate play zones with appropriate equipment for younger and older children. Splash pad or spray parks.

E4 Outdoor Dining Areas Type-Specific Requirements

Intent:

Provide valuable food-service amenities to users of outdoor spaces.

Requirements:

- Outdoor dining within right-of-way—e.g. sidewalk cafes or streateries--shall comply with all applicable regulations of Metro departments regarding use of this space.
- The perimeter of outdoor dining areas shall be clearly defined. Barriers of a minimum height of 30 inches and maximum height of 42 inches shall be provided on the curb side of outdoor dining adjacent to a vehicular travel lane.
- Outdoor dining facilities shall provide appropriate waste receptacles within 10 feet of the primary entrance.
- Outdoor dining on private property (e.g. food vendors, kiosks, and shared outdoor dining spaces) shall be publicly accessible.

Recommendations:

- Provide heating devices during the cool season and shade structures during the warm season to extend the seasons.
- Provide generous entrances and circulation paths to accommodate the various demands of an outdoor dining facility.

E5 Splash Pads and Spray Parks Type-Specific Requirements

Intent:

To engender vibrancy, livability, and provide spaces for multigenerational play.

Requirements:

- Splash pads shall be equipped with adequate, shaded seating within 20 feet for adult supervision.
- Splash pads surfaces shall meet NSF/ANSI 50 Safety standard for slip resistance, impact absorption, and cleanability.
- Splash pads shall provide appropriate signage outlining terms of use.

Recommendations:

- Design areas appropriate to different age groups with gentler water features for younger children.
- Design gentle slopes for water features to drain into depressions and other desired areas.
- For safety of younger children any features within water play areas, should be smooth and rounded, avoid sharp angular surfaces.
- Splash pads are encouraged on South-facing sites with ample sun during the warm season.

E6 Through-Block Plazas Type-Specific Requirements

Intent:

Increase pedestrian connectivity by providing through-block passageways and spaces.

Requirements:

- Through block plazas shall contain at least one circulation path at least 10 feet in width connecting the two streets. This path is not required to be direct or linear—that is, it can meander.

Recommendations:

- Provide human-scale plantings and furnishings to engender a comfortable scale.
- Program with '18-hour' uses—such as outdoor cafes—to bolster safety and security.

This page left intentionally blank

Section IV: General Standards

Bonus Height Program

Introduction

The Bonus Height Program (BHP) is a voluntary program available to properties zoned Downtown Code (DTC). It allows properties to earn additional building height in exchange for contributing to specified programs that provide benefits to the public or advance the quality of urban design required by the DTC's base standards. The Bonus Height shall be permitted, up to the sites Bonus Height Maximum, if the proposed development contributes to specific public benefits in the amount and manner set forth herein. The BHP is entirely optional and compliance with the specified programs is only required if an applicant is requesting Bonus Height. The BHP does not prohibit applicants from achieving by-right entitlements, outlined in the DTC.

The DTC, the Downtown Plan, other policies, official guidelines (such as the Downtown Code Design Guidelines), regulations from governing agencies, and other best practices shall be consulted when considering a DTC Concept Plan. No standard within the DTC shall relieve a project of the review process associated with a Concept Plan application.

The contents hereinafter, developed over a two-year public process and becoming effective on _____ (BL2025-____), should be considered as phase one of an update to the BHP. A second phase, that will introduce an attainable housing bonus, will be developed and incorporated into the DTC in 2025.

General Standards

- Multiple Bonus Options may be utilized insofar as the total Bonus Height does not exceed the site's Bonus Height Maximum.
- Transfer-Eligible Bonus Height may be transferred one time to a Receiving Site within the DTC, provided it does not exceed the Bonus Height Maximum of the Receiving Site.
- Transfer-Eligible Bonus Height that has been earned through previous iterations of the DTC Bonus Height Program may still be Transfer-Eligible in its full amount, provided it does not exceed the Bonus Height Maximum of the Receiving Site and provided that the original site remains vested in its BHP entitlements.
- Earned Bonus Height and Transfer-Eligible Bonus Height may NOT be applied on top of any Historic Asset.
- Earned Bonus Height and Transfer-Eligible Bonus Height may NOT be applied to a site in which a Historic Asset was demolished after the effective date of this bill, and within the 10 years prior to the request for Bonus Height, unless the demolition was caused by events outlined under "Civil Emergency" in Chapter 2.08, Article II of the Metropolitan Code of Ordinances.

Bonus Height Certification

- Prior to obtaining building permits, any project seeking Bonus Height must submit a Bonus Height Certification application for review. This application is certified by the Metropolitan Planning Commission at their regular meetings as an administrative action. No public hearing is required.
- The Bonus Height Certification application may require exhibits including, but not restricted to, those that demonstrate a project's compliance with the BHP, a declaration of restrictive covenants, and/or other commitments to adhere with the standards outlined within this section. A full list of submittal requirements can be found on the Metropolitan Planning Department's website.

Section IV: General Standards

Bonus Height Program

Baseline Requirements

Applicability: In order to earn Bonus Height through Bonus Options or Transfer-Eligible Bonus Height, new development of 50,000 GSF (gross square feet) or greater shall fulfill Baseline Requirements.

New development under 50,000 GSF is not required to meet the Baseline Requirements. However, if the development does meet the Baseline Requirements, it shall be eligible for the corresponding Bonus Height Award, described below.

Bonus Height Award: Fulfillment of the Baseline Requirements shall yield a flat-rate two stories of Bonus Height – each equal to the Typical Bonus Floorplate Area (in SF) of the proposal.

Modifications: The DTC modification types and decision processes, outlined on page 14, shall be used when evaluating modifications to the BHP's Baseline Requirements. However, modifications to the BHP's Baseline Requirements may also be considered based on site-specific conditions that make the fulfillment of said requirement an unsuccessful implementation of the desired use(s) on the site or an unsuccessful result of site or architectural design.

Bonus Height Program Overview

Baseline Requirements (page 104-105)

- A** Green Building Certification
- B** Upper-Level Garage Liner Building
- C** Active and Sustainable Transportation

Fulfillment of the BHP's three Baseline Requirements yields a flat-rate **+2 Stories** of Earned Bonus Height.

Bonus Options (page 106-110)

- 1** Elevated Green Building Certification
- 2** Preservation
- 3** Privately-Owned Public Spaces (POPS)
- 4** Neighborhood Support Space
- 5** Reduction of Vehicular Parking
- 6** Underground Parking

Fulfillment of any Bonus Option yields an amount of Earned Bonus Height, determined by the Bonus Option's *Bonus Height Calculation* methodology.

Note:

When Bonus Option 2 (Preservation) is utilized, Baseline Requirement A (Green Building Certification) will not be required to be fulfilled to earn the **+2 Story** flat-rate Bonus Height Award.

Section IV: General Standards

Bonus Height Program

Definitions

In addition to the following definitions, which are intended to be used solely for DTC properties, please reference Section 17.04.060 - Definitions of general terms, as outlined in the Metropolitan Code of Ordinances.

- **Applied Bonus Height:** Earned Bonus Height that has been constructed on the same site where it was earned.
- **Available Bonus Height:** The difference between a site's Bonus Height Maximum and Maximum Height.
- **Baseline Requirement:** Requirements that must be fulfilled before Bonus Options become available for use.
- **Bonus Height:** Any building height that exceeds a site's Maximum Height.
- **Bonus Height Maximum:** The height (in stories) a site can build by utilizing the Bonus Height Program.
- **Bonus Option:** Optional requirements that, if fulfilled, yield Bonus Height.
- **Cultural Asset:** A structure or site that is not a Historic Asset, but that still is important to history, culture, and/or worth preserving for other reasons. These assets may or may not be identified by the Metropolitan Historic Zoning Commission as eligible for listing on the National Register of Historic Places (NRE) or worthy of conservation (WOC).
- **Earned Bonus Height:** Bonus Height earned through the culmination of one or more Bonus Options.
- **Gross Square Feet (GSF):** The entire square footage of a building, whether used by the building's occupants or not. GSF typically includes areas such as the building core, maintenance and operations areas, stairwells, elevator shafts, equipment areas, attics, garages, balconies, excavated basement areas, mezzanines, corridors and walkways.
- **Historic Asset:** A structure or site listed on the National Register of Historic Places (NR) OR designated as a National Historic Landmark (NHL).
- **Maximum Height:** The entitled height (in stories) a site can build without utilizing the Bonus Height Program.
- **Protected Asset:** At least one of the following must be true:
 - » The structure or site is located within a local historic overlay (as outlined in Chapter 17.36, Article III, of the Metropolitan Code of Ordinances).
 - » The structure or site is protected pursuant to a declaration of restrictive covenants (per the requirements of Path #2 under the Preservation Bonus) on file with the Davidson County Register of Deeds.
 - » The structure or site has a Preservation Easement held by Historic Nashville, Inc. (HNI), or another similar entity.
 - » The structure was built pre-1865 (see Chapter 16.28.195 of the Metropolitan Code of Ordinances) and therefore has additional protections against demolition.
- **Receiving Site:** A single parcel or group of adjacent parcels with common ownership, or up to two adjacent parcels without common ownership on which Transferred Bonus Height can be constructed.
- **Transfer-Eligible Bonus Height:** Earned Bonus Height that has not been applied at the same site where it was earned, or Earned Bonus Height that exceeds the earning site's Bonus Height Maximum.
- **Transferred Bonus Height:** Bonus Height that has been transferred from the site where it was earned and constructed on another site.
- **Typical Bonus Floorplate Area:** The average size of a building's bonus floorplates, calculated as the GSF of the building's bonus floors divided by the number of stories that exceed the site's Maximum Height.

Section IV: General Standards

Bonus Height Program: Bonus Height Chart

	Maximum Height	Bonus Height Maximum
Central		
James Robertson		
	560' above sea level	560' above sea level
Core		
	30 stories	unlimited stories
Core-Historic		
	6 stories on the interior of blocks; 10 stories on the corners	10 stories
Upper Broadway		
	100'	100'
Second and Broadway		
Second	8 stories in 105'	8 stories in 105'
Broadway	5 stories in 65'	5 stories in 65'
SoBro		
General, or 8th Avenue frontage south of roundabout (beyond 100' from frontage)	30 stories	unlimited stories
West side of 1st and East side of 2nd 8th Ave frontage south of roundabout (within 100' frontage)	15 stories	30 stories
	8 stories	11 stories
River		
	10 stories	10 stories
South		
Lafayette		
General	8 stories	18 stories
Transitional Properties	15 stories	22 stories
Lafayette Street	12 stories	20 stories
Rutledge Hill		
Primary and secondary	6 stories	7 stories
Tertiary	3 stories	3 stories
Rolling Mill Hill		
	65' with a SEP of 1:1.5	65' with a SEP of 1:1.5
Rutledge River		
	9 stories	12 stories
West		
Gulch North		
General	7 stories	10 stories and below 560' above sea level
Fronting Herman Street	4 stories	4 stories
Gulch South		
General	10 stories	18 stories
Mid-Gulch Properties	10 stories	18 stories
Fronting Church, Broadway, Demonbreun	15 stories	23 stories
Gulch South Intersections	20 stories	30 stories
Mid-Gulch Intersections	20 stories	30 stories
North		
Hope Gardens		
Primary	7 stories	8 stories
Secondary	4 stories	5 stories
Tertiary	3 stories	3 stories
Sulphur Dell		
Primary	7 stories	8 stories
Secondary	5 stories	6 stories
Tertiary	4 stories	5 stories

Section IV: General Standards

Bonus Height Program: Baseline Requirements

A Green Building Certification Baseline Requirement

Significance: Green building certification helps ensure the longevity of Downtown Nashville's building stock by requiring sustainable design, construction, and operational practices that reduce carbon, water, energy, and waste. By establishing baseline sustainability targets for new development, Downtown Nashville will become more future-focused and ecologically friendly.

Requirements:

1. Sites located in a LEED for Neighborhood Development (LEED ND) [see below note] neighborhoods shall be LEED Certified.
2. All other sites shall obtain LEED Silver Certification.

Alternative Compliance: Applicants may propose an equivalent, nationally recognized, third-party system of overseeing green building and/or sustainable development practices uses to Planning Staff. If proposing to use an alternate certification system, applicants must demonstrate how each credit in the proposed system is directly comparable to the LEED-equivalent credit.

Notes:

Bonus Height may be earned through the Green Building Certification Bonus Option (page 106) for Gold-level or higher certification.

When Bonus Option 2 (Preservation) is utilized, Baseline Requirement A (Green Building Certification) will not be required to be fulfilled to earn the +2 Story flat-rate Bonus Height Award.

Only sites within the following LEED ND neighborhoods shall qualify for the 'LEED Certified' Green Building Certification Baseline Requirement: The Gateway to Nashville (ID:0010102848) and The Gulch (ID:0010102851).

B Upper-Level Garage Liner Building Baseline Requirement

Significance: The Downtown Code does not require any vehicular parking; however, vehicular parking spaces may be provided up to the maximum number prescribed in Chapter 17.20, Article II of the Metropolitan Code of Ordinances. Reducing the visual and physical impacts of vehicular parking by locating upper-level structured parking behind liner buildings, enhances Downtown Nashville's pedestrian experience and architectural design quality.

Requirements:

1. All upper-level structured parking must include habitable liners (conditioned space), at least 15 feet in depth, along all street, interstate, and outdoor space frontages.
2. Upper-level structured parking on non-street-facing property lines does not require habitable liners, but must be enclosed with solid, fire-rated materials, ensuring compatibility with potential future adjacent redevelopment.
3. The above requirements are encouraged but shall not apply to buildings with 80% or more of their GSF comprising of Office uses. However, these buildings must screen upper-level structured parking with solid wall cladding, along all street, interstate, and outdoor space frontages. In this scenario, the following shall also apply:
 - a. Screening elements should have a gap of no more than 18" from the outer face of the screen element to the wall.
 - b. Screening elements beyond 60' continuous length should be interspersed with different patterns and articulation strategies.
 - c. To screen vehicular headlights and mechanical equipment, screening elements, including rooftop parapets, shall be semi-opaque (minimum 60% transmission) up to 4 feet in height from each garage finish floor level. Otherwise, a mix of transparent and opaque materials shall be used.
 - d. Design of the screening elements should maintain appropriate relationships to building design and should be maintained in good condition at all times.

Note: Refer to DTC pages 82-83 for additional requirements for structured vehicular parking.

Section IV: General Standards

Bonus Height Program: Baseline Requirements

C Active and Sustainable Transportation Baseline Requirement

Significance: Downtown Nashville's recent growth has brought unprecedented amounts of single occupancy vehicle trips, traffic congestion, and air pollution. By integrating active and sustainable transportation modes in new development, traffic congestion will be reduced and moving around Downtown will become easier.

Requirements: Heightened bicycle parking standards, provisions for provided vehicular parking, and multimodal transportation information shall be required. Note: Any facilities required through this Baseline Requirement shall not be eligible for Bonus Height through the Neighborhood Support Space Bonus Option. However, facilities provided in excess of these requirements may be eligible for the Bonus Option.

- **Ample Bicycle Parking Capacity:** Bicycle parking shall be provided for all uses in a development (as outlined in Section 17.20.135 of the Metropolitan Code of Ordinances), however, the maximums on number of bicycle parking spaces shall not apply.
- **Bicycle Commuter Amenities:** Amenities for bicycle commuters, along with at least 50% of a development's required bicycle parking, shall be located together in a secure place, accessible by its users by either lock and key or key fob technology. The secure location shall be easily accessed from the exterior of the building and an access route plan shall be provided at Concept Plan submittal. The following bicycle commuter amenities must be provided:
 - » For any development with 100,000 GSF of non-residential uses, at least two combined shower/changing rooms and clothing lockers shall be provided. Two additional combined shower/changing rooms and additional clothing lockers shall be provided for every additional 200,000 GSF of non-residential uses in the development.
 - » Residential uses containing 10 or more units, and non-residential uses with more than 50,000 GSF shall provide at least one bicycle repair station or equivalent facility for bicycle repair and maintenance.
 - » For the purposes of charging e-bikes, one standard electrical outlet shall be provided for every five bicycle parking spaces.
 - » For the purposes of storing non-standard bicycles (such as cargo or adaptive bikes), at least one required bicycle parking space shall be 120 inches long and 30 inches wide.
- **Electric Vehicle Parking:** Where new vehicular parking is being provided, Electric Vehicle (EV) parking, in accordance with the DTC's EV Parking Standards (page 82), shall be provided as follows:
 - » For multifamily and hotel uses that provide more than 50 vehicular structured parking spaces, 2% of spaces shall be EVSE-Installed and 10% of spaces shall be EV-Capable.
 - » For office and institutional uses that provide more than 200 vehicular structured parking spaces, 2% of spaces shall be EVSE-Installed and 10% of spaces shall be EV-Capable.
- **Sustainable Vehicle Preferential Parking:** Where new vehicular parking is being provided, at least five of the most desirable vehicular parking spaces (meaning closest to the ground floor and the building's lobby) shall be reserved for tenants/employees/visitors who use a sustainable vehicle such as an EV, plug-in hybrid, carpool, or vanpool. These parking spaces shall be signed as "Reserved for Sustainable Vehicles (EVs, Plug-In Hybrids, Carpools, or Vanpools)". Two additional vehicular parking spaces should be signed as described above, for each 100,000 GSF of building space.
- **Multimodal Transportation Information:** Office, institutional, hotel, and multifamily lobbies shall include a display (e.g., information kiosk or digital screen) that provides information on the surrounding multimodal transportation options. Information shall be location-specific and shall include transit and shuttle maps and schedules, bike maps, location of car share, bike share, dockless mobility options, and any preferential carpool parking spaces.

Section IV: General Standards

Bonus Height Program: Bonus Options

1 Elevated Green Building Certification Bonus Option

Significance: Green building certification helps ensure the longevity of the building stock in Downtown Nashville by requiring sustainable design, construction, and operational practices that reduce carbon, water, energy, and waste.

Eligibility: New development that achieves LEED Gold, Platinum, or Zero Certification shall be eligible for this bonus.

Prior to Bonus Height Certification, applicants shall:

- For LEED Gold and Platinum, provide pre-certification scorecards.
- For LEED Zero, provide prescriptive design solutions that would confirm that LEED Zero is feasible once the building is occupied.
- For LEED Zero, execute a declaration of restrictive covenants committing the property owner to provide Planning staff with annual reports showing compliance with LEED Zero in perpetuity, which declaration shall be reviewed and signed by the Executive Director of the Metropolitan Planning Commission, or their designee and recorded with the Davidson County Register of Deeds.

Alternative Compliance: Applicants may propose an equivalent, nationally recognized, third-party system of overseeing green building and/or sustainable development practices uses to Planning Staff. If proposing to use an alternate certification system, applicants must describe how each credit in the proposed system is demonstrably similar to the LEED-equivalent credit.

Bonus Height Calculation: The bonus height awarded shall be:

- 4 Stories for LEED Gold or equivalent
- 20 Stories for LEED Platinum or equivalent
- 40 Stories for LEED Zero or equivalent

Notes:

Each story of bonus height shall be equal to the Typical Bonus Floorplate Area (in SF) of the proposal.

A site receiving Transfer-Eligible Bonus Height from a Sending Site that used the Preservation Bonus Option, and seeking its own Bonus Height through the BHP, shall not be required to fulfill the Green Building Certification Baseline Requirement. However, the Receiving Site shall be eligible to use the Green Building Certification Bonus Option and receive two stories of Bonus Height for Silver-level certification, or what is already offered for Gold-level or higher certification.

Section IV: General Standards

Bonus Height Program: Bonus Options

2 Preservation Bonus Option

Significance: The preservation and/or re-use of Downtown Nashville's historic or otherwise culturally significant structures and sites is critical to maintaining the history and identity of our city.

Required Applicability: This Bonus Option must be used for sites containing an unprotected Historic Asset(s), that are seeking Bonus Height through the BHP.

Eligibility: Any Historic Asset – or any Cultural Asset that receives written permission from the Metropolitan Planning Commission, or its designee – shall be eligible for this bonus if the asset's preservation is formalized through one of the following paths:

- **Path #1:** An asset eligible for an Historic Overlay (as defined in Chapter 17.36, Article III of the Metropolitan Code of Ordinances) shall apply for and receive approval to place an Historic Overlay on the property from the Metropolitan Council. This requires recommendations from the Metropolitan Historic Zoning Commission and the Metropolitan Planning Commission.
- **Path #2:** An asset ineligible for an Historic Overlay (as defined in Chapter 17.36, Article III of the Metropolitan Code of Ordinances) must obtain a determination as to its ineligibility from the Metropolitan Historic Zoning Commission. The owner shall then record a declaration of restrictive covenants (to be reviewed and signed by the Executive Directors of the Metropolitan Planning Commission and the Metropolitan Historic Zoning Commission, or their designees) with the Davidson County Register of Deeds, containing the following information:
 - » A list/description of the features of the structure or site to be preserved and general guidance on preservation created by the Metropolitan Planning Commission and Historic Zoning Commission, as to matters within their jurisdiction, or their designees.

- » An agreement to preserve those defining features of the structure or site, as identified by the Metropolitan Planning Commission and Historic Zoning Commission, as to matters within their jurisdiction, or their designees, in perpetuity by requiring that any exterior alterations, including demolition in whole or in part, be reviewed and approved by the Metropolitan Planning Commission and Historic Zoning Commission, as to matters within their jurisdiction, or their designees, following the Commission's processes and policies. If applicable, The Secretary of Interior's Standards for the Treatment of Historic Properties with Guidelines for Preserving, Rehabilitating, Restoring & Reconstructing Historic Buildings, and any other design guidance may be referenced.
- » An agreement to forfeit any future claim for additional building intensity or development, including any type of variance of the preserved building.
- » The building/site area being preserved (in square feet), and the amount of bonus height (in square feet) being derived from its preservation.

Bonus Height Calculation: The bonus height awarded shall be the greater of the two calculations:

- 16,000 SF of bonus height for each unbuilt story, up to the site's Maximum Height.
- 24,000 SF of bonus height for every 10,000 GSF of preserved structure or site.

If the Earned Bonus Height yielded from this Bonus Option is unable to be applied on the same site, or on an adjacent site, without applying the Bonus Height on top of the preserved structure (or another similar impact to the preserved structure), the Earned Bonus Height will be doubled and shall only be permitted to be transferred off-site.

Section IV: General Standards

Bonus Height Program: Bonus Options

3 Privately-Owned Public Space (POPS) Bonus Option

Significance: A vibrant public outdoor space network is essential to a functional and livable Downtown Nashville. These spaces improve quality of life by promoting mental and physical health and providing a sense of community and social cohesion. Furthermore, public outdoor spaces provide opportunities for built-in resiliency through quality design.

Eligibility: Any POPS proposed in the DTC that meets the Outdoor Space General Standards (page 88), the POPS Performance Requirements outlined hereinafter, and fulfills at least one of the following two paths, may be eligible for this bonus:

- **Path #1: Sustainable Site Design.** The proposed POPS shall obtain SITES certification or WEDG verification.

Alternative Compliance: Applicants may propose an equivalent, nationally recognized, third-party system of overseeing resilient or sustainable site design to Planning Staff. If proposing to use an alternate certification system, applicants must describe how each credit in the proposed system is demonstrably similar to the SITES or WEDG-equivalent credit.

- **Path #2: Priority Outdoor Programming.** The proposed POPS shall incorporate outdoor programming (see table to the right), as follows:

Area of POPS	Minimum Requirement
Less than 5,000 SF	1 priority element + 1 amenity
5,000 - 10,000 SF	1 priority element + 2 amenities OR 2 priority elements + 1 amenity
Greater than 10,000 SF	2 priority elements + 2 amenities

Priority Elements
<ul style="list-style-type: none"> • Active recreation feature—e.g. bocce, lawn bowling, corn hole, basketball court, pickleball court • Conditioning element—mistert, shade structure, shelter, or pavilion • Outdoor food service such as open-air café, concessionaire, or retail kiosk • Fountain or reflecting pool • Play facility or play area—e.g. swings, see-saws, slides • Playground • Passive recreation feature—e.g. game tables and seating • Interactive public art other than murals • Public restrooms • Water feature—e.g. splash pad • Docked bike-share (pending NDOT approval) • Stairs or vertical connection to a viaduct or other elevated public space • Greenway connections
Amenities
<ul style="list-style-type: none"> • Bike parking and repair station • Community garden • Dog Park • Fitness Equipment • Sculpture art • Gathering space with flexible seating and tables • Performance Stage • Pollinator or sensory garden • Water fountain

Notes:

Applicants are encouraged to propose other Priority Elements and Amenities, similar to those described above, to Planning Staff for consideration. Appeals to Staff decisions may be made to the DRC.

Transfer-Eligible Bonus Height may be transferred one time to a Receiving Site within the DTC, provided it does not exceed the Bonus Height Maximum of the Receiving Site.

Section IV: General Standards

Bonus Height Program: Bonus Options

POPS Performance Requirements:

- *Maximize Human Comfort and Safety*
 - » Occupiable outdoor spaces shall be designed with shade elements or canopy trees, so that the habitable or occupiable area has a minimum of 15-20% shade coverage during the warm season months of May through September.
 - » Specified light fixtures shall be Dark Sky compliant
- *Bolster Sustainability and Resilience to Climate Change*
 - » Refuse bins shall be provided and shall accommodate trash and recycling separately with clear, distinguishing labels.
 - » A minimum of twenty-five percent of trees and shrubs shall be of species native to the Southeastern USA Plains Ecoregion (US EPA Level II, 8.3) and their variants and cultivars—e.g. Dura Heat® River Birch.
 - » A minimum of fifteen percent of proposed herbaceous plants shall be species native to the Southeastern USA Plains Ecoregion (their variants or cultivars—e.g. Echinacea purpurea ‘White Swan’ or Panicum virgatum ‘Shenandoah’).

Bonus Height Calculation: The bonus height awarded shall be equal to the area of the POPS (in SF) multiplied by the total number of unbuilt stories over the POPS, up to the proposed building height, or the site’s Bonus Height Maximum – whichever is greater.

POPS (or portions thereof) that are located underneath cantilevered building footprint are not eligible for Bonus Height unless the space is activated by a civic, institutional, or neighborhood support use.

Additional multipliers, outlined below, may be used to increase the Earned Bonus Height yielded by this Bonus Option.

- *Pervious Surface:* For POPS that include pervious surfaces that meet the DTC’s Open Space General Standards (page 88) within their boundaries, an additional two SF of Bonus Height shall be awarded for every square foot of pervious surface provided (landscaped areas excluding turf or sod and tree canopy), and an additional one SF of Bonus Height shall be awarded for every one square foot of semi-pervious surface (turf, permeable pavers, or permeable asphalt).
- *Deficiency Area:* For POPS located within a deficiency area (an area that lacks another publicly accessible open space within a ¼-mile radius), an additional two SF of Bonus Height shall be awarded for every square foot of POPS provided.
- *Sustainable Site Design:* For POPS that demonstrate sustainable site design by obtaining either SITES or WEDG certification, an additional two SF of Bonus Height shall be awarded for every square foot of POPS provided.
- *Priority Outdoor Programming:* For POPS that include at least one priority element from the list above, an additional five SF of Bonus Height shall be awarded for every square foot of space dedicated to the priority element(s) and amenities provided.

Section IV: General Standards

Bonus Height Program: Bonus Options

4 Neighborhood Support Space Bonus Option

Significance: Downtown Nashville is made up of several distinct neighborhoods, with thousands of residents. Complete neighborhoods are places where residents' daily needs can be met. Spaces for services, amenities, or businesses that contribute to these needs are important to ensuring Downtown Nashville's neighborhoods are complete.

Eligibility: Neighborhood Support Spaces shall be occupied by those uses that are generally located on the ground floor (with possible exceptions for upper or lower levels with direct access to the public ROW) and that achieve one of the following:

1. Spaces that fulfill an individual's daily or weekly needs
2. Spaces that strengthen the surrounding community
3. Spaces for non-profits or other organizations that directly serve a community

Applicants shall propose the list of potential uses for the space at Concept Plan submittal for review by Staff. Appeals to Staff decisions may be made to the DRC.

Prior to Bonus Height Certification, a declaration of restrictive covenants with the following information shall be reviewed and signed by the Executive Director of the Metropolitan Planning Commission, or their designee and recorded with the Davidson County Register of Deeds:

- The reservation of the Neighborhood Support Space for at least 15 years. Adherence to this standard shall be checked annually by the Metropolitan Planning Commission or its designee. The Neighborhood Support Space may be occupied by one or multiple tenants in the 15-year timeframe.
- The building area being reserved for the Neighborhood Support Space (in square feet), and the amount of bonus height (in square feet) being derived from it.

Bonus Height Calculation: The bonus height awarded shall be the area (in square feet) reserved for Neighborhood Support Space(s), multiplied by 15.

5 Reduction of Vehicular Parking Bonus Option

Significance: Already the most walkable, bike-friendly, and transit-focused part of the city, Downtown Nashville does not require vehicular parking spaces by code. Parking maximums exist to limit the number of parking spaces that new development can include. The reduction of vehicular parking spaces within a Downtown Nashville development further supports our shared mobility goals – encouraging pedestrian activity, bicycling, and transit ridership.

Eligibility: Developments that provide fewer vehicular parking spaces than what parking maximums allow (as outlined in Chapter 17.20, Article II of the Metropolitan Code of Ordinances) shall be eligible for this bonus.

Bonus Height Calculation: The bonus height awarded (in square feet) shall be equal to the number of vehicular parking spaces that the development would be allowed, but is not providing, multiplied by 255 (the typical area needed for one parking space and its portion of the drive aisle).

6 Underground Parking Bonus Option

Significance: The DTC does not require any vehicular parking, however, vehicular parking spaces may be provided up to the maximum number prescribed in Chapter 17.20, Article II of the Metropolitan Code of Ordinances. Reducing the visual and physical impacts of vehicular parking, enhances Downtown Nashville's pedestrian experience and architectural design.

Eligibility: Developments that provide either a portion of or all vehicular parking spaces within an underground structured parking garage shall be eligible for this bonus.

Bonus Height Calculation: The bonus height awarded shall be:

- 1 Story for developments where the number of upper-level structured parking levels with habitable liners on all public street frontages and open spaces do not exceed the number of underground parking levels.
- 2 Stories for developments where all vehicular parking is located underground.

Note: Each story of bonus height shall be equal to the Typical Bonus Floorplate Area (in SF) of the proposal.

Section V : Sign Standards

Section V: Sign Standards

Introductory Provisions

Intent

The purpose of these regulations is to set specific sign standards that accomplish the following:

- Establish reasonable and improved standards for Downtown business identification;
- Encourage creative and innovative approaches to regulating signs consistent with the principles of the Downtown Community Plan;
- Promote economic vitality in Downtown;
- Enhance the overall visual environment in Downtown by discouraging signs that contribute to the visual clutter of the streetscape;
- Ensure signs are designed for the purpose of identifying a business in an attractive and functional manner; and
- Ensure signs reinforce the existing and envisioned character and are complementary to the architectural design of Downtown.

Applicability

- These sign regulations apply to all properties zoned DTC and are not in an Historic Zoning Overlay. See map on Page 107.
- In addition to the standards set forth within this section, the following Sections of the Metro Zoning Code shall apply to all regulated signage within the DTC.
- Section 17.04.06 - Definitions of general terms
- Within Chapter 17.32 SIGN REGULATIONS:
 - » Section 17.32.020 - General Provisions
 - » Section 17.32.040 - Signs allowed without a permit
 - » Section 17.32.050 - Prohibited signs
 - » Section 17.32.060 - Permitted on-premises temporary signs
 - » Section 17.32.145 - Landmark signs
 - » Section 17.32.160 - Computations
- Within Article XI. Sign Procedures
 - » 17.40.490 - Permits and compliance tag.
 - » 17.40.510 - Unsafe, illegal, dilapidated and abandoned signs

Sign Permit Applications

Applications for sign permits shall be made with and reviewed by the Codes Department. All sign

applications that do not involve Modifications shall only require Codes Department approval, regardless of whether the property is subject to additional design guidelines (e.g. MDHA redevelopment districts).

Applicants for sign permits shall submit the following information. Incomplete applications will not be accepted.

- Design and details of the signage depicting size and shape (including height, width and depth), anchoring, materials, lighting and other data necessary to determine compliance with the requirements of this section and with the requirements of the Metropolitan building code and the Metropolitan electrical code. Additional information may be required by Codes.
- Drawings and specifications, including building elevations or artist's rendering depicting the sign faces, and dimensions indicating sign placement on the building.
 - » For ground signs and signs seeking a ROW encroachment, the distance of the signs from the corner of the building or property line should be included.
- A site plan, drawn to scale, depicting the location of the proposed signage and all relevant features of the site, including location and size of other regulated signs.
- The property address, applicant and sign designer's name and contact information.

Common Sign Plan

A common signage plan regulates signage for multiple businesses or tenants within one building or complex. A common sign plan is mandatory for all new developments and sign Modifications.

- A common signage plan shall provide for consistency among signs with regard to at least four of the following: materials; location of each sign on the building; sign proportions; color scheme; lighting; lettering or graphic style.
- The common signage plan shall establish an allowable area of signage for existing and future tenants with regard to all allowed signs types.
- The common signage plan shall indicate existing nonconforming signs as well as the amount and location of on-premises signage to be allocated to each tenant under the new plan.

Section V: Sign Standards

Modifications

Sign Permit Modifications

Requests for modifications to sign standards are reviewed through the process outlined on pages 14 and 15. Modifications are reviewed by Planning staff and either the MDHA Design Review Committee or the DTC Design Review Committee. The applicant may appeal a decision through the process described on pages 14 and 15. All sign Modifications are Major Modifications. Two additional types of Modifications for signage related permits may be requested and are outlined below.

Modifications for Exceptional Design

Creative signage that does not fit the specific regulations of this section may be considered by the appropriate reviewing body (listed above), based on its merits, as they relate to all of the following design criteria:

- architecture
- the configuration or location of the building or property
- building scale
- legibility
- technical competence and quality in design, construction and durability

Applications for this type of Modification require submittal of a common sign plan for the property in question. Approval of any related structures (i.e. canopy) will require review by all applicable agencies. Exceptional design modifications shall not permit electronic changeable copy where it is otherwise not permitted.

Modifications for Tourist-oriented Businesses

Tourist-oriented businesses within DTC zoning may receive Modifications to allow greater sign area and use of digital technology. To qualify as a tourist-oriented business a business shall:

- have a minimum permanent fixed seating capacity of 500; and
- offer lawful activities or services to the general public of cultural, historical, recreational, educational, or entertainment purposes.

Applications for this type of Modification require submittal of a common sign plan for the property in question. Approval of any related structures (e.g.

canopy) will require review by all applicable agencies. Tourist-oriented business Modifications shall be reviewed according the design criteria listed under Modifications for Exceptional Design, above, in addition to the following:

- Large electronic or illuminated signs shall not adversely impact residential or hotel uses.
- All signs shall conform to the lighting standards of the DTC.
- See page 119 for additional information on changeable copy.

Right-of-way Encroachments

Where a sign is proposed to encroach into the public right-of-way an application shall be made with the Public Works Department in addition to the sign permit application with the Codes Department. Both applications shall include the requirements of the Public Works Department available at their website: <http://www.nashville.gov/pw/permits.asp>, in addition to the submittal requirements listed on the previous page.

Nonconforming Signs

Nonconforming Signs

Sections 17.40.660 and 17.40.690 of the Metro Zoning Code apply. This section further clarifies them.

Building Signs

A sign shall be brought into compliance with the provisions of the above mentioned sections if a sign permit is required to rebuild the sign. This does not include a panel change in a non-conforming cabinet sign, which shall be permitted. All new panels shall conform to all illumination standards herein.

Ground Signs

An existing ground sign may change the face or panel of a sign that does not meet the area or height standards within this section. However, in no instance shall there be an increase in the degree of nonconformity. All new panels shall conform to all illumination standards herein.

A sign shall be brought into compliance with the provisions of this title if at any time the sign is altered, repaired, restored or rebuilt to the extent that the cost exceeds fifty percent (50%) of the estimated replacement cost of the sign (in current dollar value). All permits within any six consecutive calendar months

Section V: Sign Standards

General Standards

shall be aggregated for purposes of measuring the fifty percent standard.

Repair and Maintenance

If the alteration or repair is caused by involuntary damage or casualty, the sign may be altered or repaired to its pre-damaged condition. A sign may be removed and taken off-site for repair and maintenance. The sign must be returned to the original location within 120 days of removal.

Materials

All permanent, on-premises signs shall be constructed of a rigid, weatherable material such as hard plastic, wood, MDO plywood, aluminum, steel, PVC, glass and/or Plexiglas. On-premises, permanent signs shall not be constructed of nonrigid materials including, but not limited to, vinyl, fabric, canvas, or corrugated plastic. The provisions of this subsection shall not apply to approved, permitted canopies, awnings, and porticoes.

Voluntary Removal of a Legally Non-conforming Ground Sign

Any property voluntarily removing a legally non-conforming ground sign shall be permitted to a bonus to one hundred fifty percent (150%) of the building signs allocated to the property. For example, if a property is allocated 200 sq ft of building signs, the property will be allowed 300 sq ft of buildings signs if a legally non-conforming ground sign is removed.

Building Facade and Street Frontage Measurement

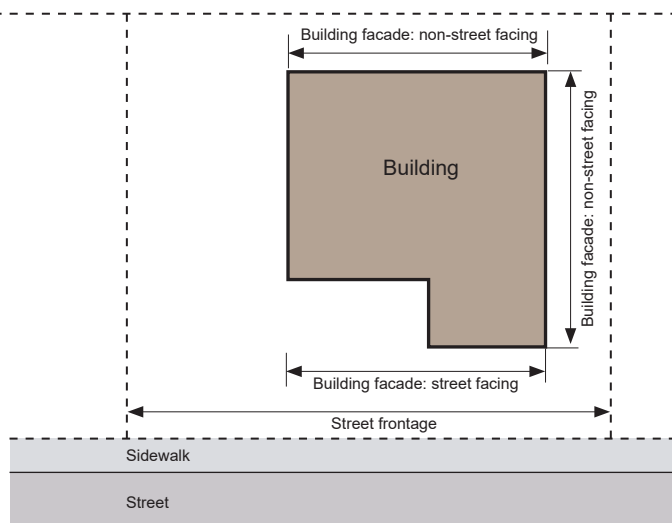

Other Sign Types

Non Street-Facing Signs

Non street-facing building facades and alley frontages, not otherwise regulated, are allocated 1 square foot of sign area per 1 linear foot of building facade, to a maximum of the sign area permitted for the primary street frontage.

This includes lots adjoining open spaces, pedestrian walkways, or parking areas. Ground signs are not permitted on non street-facing building facades or alley frontages.

Temporary Signs

Temporary signs shall follow the standards of 17.32.060.

Murals

Only the company name, text relating directly to products or services sold on site, and logos shall count toward the sign area allocation. Otherwise, murals are exempt from this code.

Auto-oriented canopy/awning Signs

The allocation of signage for auto-oriented canopies and awnings shall be measured as walls signs and shall only be used on the canopy/awning. See the Auto-oriented Canopies and Awnings section of the Downtown Code for information on the design of canopies and awnings.

Parking Lot Signs

A pole-mounted projecting sign is allowed for surface parking lots with no associated building. One sign per street frontage is allowed. The maximum size shall be 36 square feet per sign. The side of the sign shall be attached to the pole, and the pole will be considered the "building facade". All projecting sign standards shall apply (Page 114); parking lot signs shall follow the standards of a one-story building.

Section V: Sign Standards

Street Types

Pedestrian Streets

- Pedestrian streets are roadways with high pedestrian activity and slower moving vehicular traffic. Buildings along these streets are located at the back of the sidewalk creating a streetscape with active uses including retail, office and entertainment businesses.
- Pedestrian streets are generally located in the Downtown core, where more of the original street wall remains intact, and less opportunities exist for surface parking.
- Some streets outside of the Downtown core, such as Korean Veterans Boulevard (KVB), require Pedestrian designation. The MDHA and UDO standards for KVB require pedestrian-focused building design and streetscape. The standards for Pedestrian Street signage allow greater flexibility for such streets.

Gateway Streets

- Gateway streets are wider roadways that serve pedestrians, but focus primarily on automobile traffic and typically carry traffic at higher speeds than Pedestrian Streets.
- Generally located on the fringe of Downtown, Gateway streets serve as the key automobile entry points into Downtown.

Transitional Streets

- Transitional streets currently contain a mix of different building characters, transitioning from more auto oriented buildings and uses to a more mixed use pedestrian environment.
- As these street redevelop, buildings will be sited close to the sidewalk with a more pedestrian focus.

Interstate

- Many properties are visible from the interstate loop which moves vehicles into and through Downtown.
- The opportunity to advertise to the interstate must be balanced with the safety of drivers and preservation of Nashville's iconic skyline.

Printers' Alley





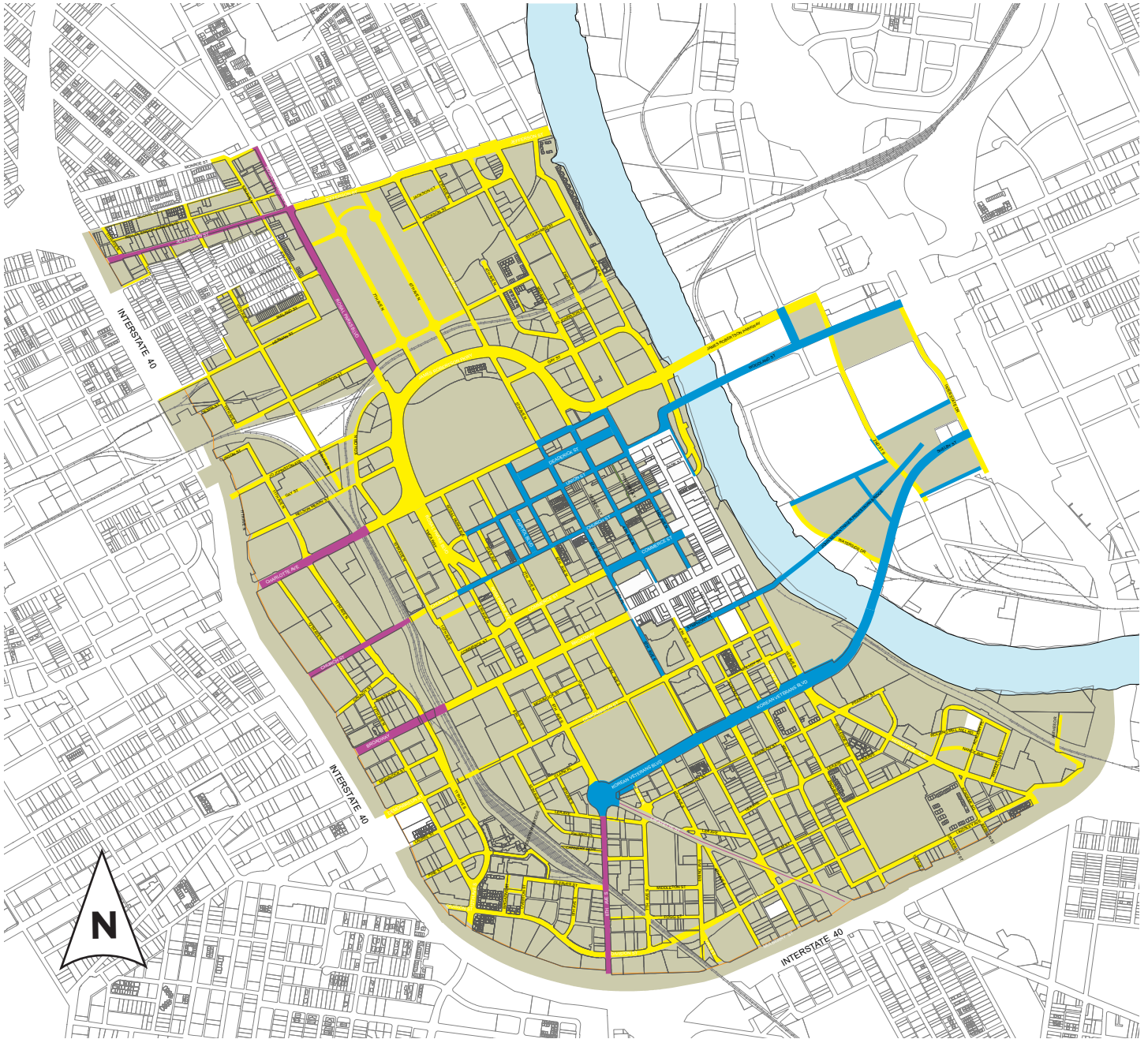

- Printers' Alley is a unique, iconic alley in Downtown. As a public, pedestrian-only street with businesses on the ground floor and upper floors, unconventional standards apply to this street only.

Section V: Sign Standards

Signs: Map of Street Types for Signage Standards



Legend

	Transitional Street		Interstate
	Pedestrian Street		Printers' Alley
	Gateway Street		Applicable properties

- New streets that are not in existence as of the adoption of this ordinance shall be categorized as Transitional Streets.
- Properties within an Historic Zoning Overlay and/or with SP zoning are not subject to the sign standards of DTC zoning.

Section V: Sign Standards

Determining Sign Entitlements

Use this page as a guide to determine the sign entitlements of a property. You will need to know the length of the building on all street frontages, the length of alley frontages, and the length of all interior property lines.

STEP 1

What Street Types is the property on? Page 106

- Pedestrian
- Transitional
- Gateway
- Interstate
- Printers' Alley

STEP 2

How much square footage of signage is allowed? Pages 109-110

- Pedestrian
 - Building _____
 - Ground _____
 - Skyline _____
- Transitional
 - Building _____
 - Ground _____
 - Skyline _____
- Gateway
 - Building _____
 - Ground _____
 - Skyline _____
- Interstate
 - Building _____
 - Skyline _____
- Printers' Alley
 - Building _____
 - Skyline _____

STEP 3

What are the standards for the signs? Pages 111-117

STEP 4

What are the illumination standards for signs? Pages 118-119

STEP 5

Is changeable copy allowed? Page 119

STEP 6

- For a multi-tenant development: submit a Common Sign Plan to the Codes Department. Page 103
- For an individual tenant: submit a Sign Plan Proposal to the Codes Department. Page 103
- Additional types of signs may be allowed, depending on site conditions. Page 105

KEEP IN MIND

- There is no limit to the number of Building Signs per property.
- Sign entitlements are limited only by the total amount of square footage of signs allowed on the property, the maximum sizes of signs and the required placement of signs.
 - » For example, if a building is allowed 100 sq ft of Building Signs, that can be used in one 100 sq ft sign or in five 20 sq ft signs. The only limit is the maximum dimensions of the sign type.
- Non street-facing facades are allowed signs. Page 105
- Contact the Codes Department with questions.

Section V: Sign Standards

Allocation of Sign Area by Street Type

The maximum sign area for each type of sign is determined by the Street Type and is established in the following tables. Specific requirements for each sign type are shown on the subsequent pages.

For each cell in the table below, there is a maximum allowed sign area that may be utilized with any combination and any number of signs associated with that cell, unless otherwise noted.

The measurements for "linear feet" shall be at grade.

Pedestrian Street Type	
Building Signs	
Wall Sign Awning Sign Canopy Sign Projecting Sign	1.5 square foot of sign area per 1 linear foot of building facade or 36 square feet, whichever is greater. When a Projecting Sign is used on the building, an additional 0.5 square feet of sign area per 1 linear foot of building facade shall be permitted, for a total of 2.0 square feet per 1 linear feet of building facade.
Shingle Sign	9 square feet per sign
Ground Signs	
Monument Sign	24 square feet
Skyline Signs - area determined by average height of building	
75' to 100'	480 square feet
101' - 200'	600 square feet
201' and taller	720 square feet

Transitional Street Type	
Building Signs	
Wall Sign Awning Sign Canopy Sign Projecting Sign	1.5 square foot of sign area per 1 linear foot of building facade or 36 square feet, whichever is greater. Where no ground sign exists, an additional 0.5 square feet of sign area per 1 linear foot of building facade shall be permitted for a total of 2.0 square feet per 1 linear feet of building facade.
Shingle Sign	9 square feet per sign
Ground Signs	
Monument Sign	32 square feet Properties with 300 or more feet of frontage are allowed one additional monument sign of an additional 32 square feet
Skyline Signs - area determined by average height of building	
75' to 100'	480 square feet
101' - 200'	600 square feet
201' and taller	720 square feet

Gateway Street Type	
Building Signs	
Wall Sign Awning Sign Canopy Sign Projecting Sign	1.5 square foot of sign area per 1 linear foot of building facade or 36 square feet, whichever is greater. Where no ground sign exists, an additional 0.5 square feet of sign area per 1 linear foot of building facade shall be permitted, for a total of 2.0 square feet per 1 linear feet of building facade.
Shingle Sign	9 square feet per sign
Ground Signs	
Monument Sign	64 square feet Properties with 300 or more feet of frontage are allowed one additional monument sign of an additional 64 square feet
Skyline Signs - area determined by average height of building	
75' to 100'	480 square feet
101' - 200'	600 square feet
201' and taller	720 square feet

More Street Types on next page

Section V: Sign Standards

Allocation of Sign Area by Street Type

The maximum sign area for each type of sign is determined by the Street Type and is established in the following tables. Specific requirements for each sign type are shown on the subsequent pages.

For each cell in the table below, there is a maximum allowed sign area that may be utilized with any combination and any number of signs associated with that cell, unless otherwise noted.

The measurements for "linear feet" shall be at grade.

Interstate Street Type	
Building Signs	
Wall Sign Awning Sign Canopy Sign Projecting Sign	1 square foot of sign area per 1 linear foot of street frontage
Shingle Sign	9 square feet per sign
Ground Signs	Not allowed
Skyline Signs - area determined by average height of building	
75' to 100'	480 square feet
101' - 200'	600 square feet
201' and taller	720 square feet

Printers' Alley Street Type	
Building Signs	
Wall Sign Awning Sign Canopy Sign Projecting Sign	Ground floor: 2.0 square foot of sign area per 1 linear foot of street frontage Second floor: 1.5 square foot of sign area per 1 linear foot of street frontage Upper floors: 1 square foot of sign area per 1 linear foot of street frontage Signage allowed for each floor shall be used on that floor and shall not be redistributed to other parts of the building.
Shingle Sign	9 square feet per sign
Ground Signs	Not allowed
Skyline Signs - area determined by average height of building	
75' to 100'	480 square feet
101' - 200'	600 square feet
201' and taller	720 square feet

Section V: Sign Standards

Building Sign: Wall Sign

Description

A wall sign is a building sign that is attached flat to, or mounted away from but parallel to, the building facade.

A wall sign may be painted on the building facade.

General Provisions

- A wall sign shall either be located lower than the window sills of the third story or at the top of the building, not to be placed below the windows of the highest floor.
- No portion of a wall sign may extend above the roof line or above a parapet wall of a building with a flat roof.
- No portion of a wall sign may extend above the lower eave line of a building with a pitched roof.
- A wall sign cannot cover windows or architectural details.
- An exposed raceway shall be finished to match the background wall or be integrated into the overall design of the sign.
- A wall sign can be externally or internally illuminated in accordance with pages 118.



Design Standards

- | | |
|---------------------------------|--|
| Ⓐ Overall area allocation (max) | See pages 109-110 |
| Ⓑ Projection (max) | 13 inches |
| Ⓒ Exposed Raceway height (max) | 50% of the letter height, OR if the Raceway is used as the sign background, the Raceway may extend 3 inches beyond the largest part of the sign. |

Refer to the Illumination section (pages 118) for additional raceways standards and permitted locations.



Example of raceway incorporated as sign background

Section V: Sign Standards

Building Sign: Awning Sign

Description

An awning sign is a type of building sign. Graphics and symbols are painted, sewn, or otherwise adhered to the awning material as an integrated part of the awning itself.

General Provisions

- Only awnings on first and second story windows may contain signs.
- A maximum of one sign is allowed per awning face.
- An awning sign may only be externally illuminated.
- See the Awnings section of the Downtown Code for additional information on the design of awnings.

Design Standards

A Overall area allocation (max)	See pages 109-110
B Sign Width (max % of awning width/depth)	75%
C Height of text and graphics on valance (max)	2 feet
D Max area of sloping plane covered by sign	50%

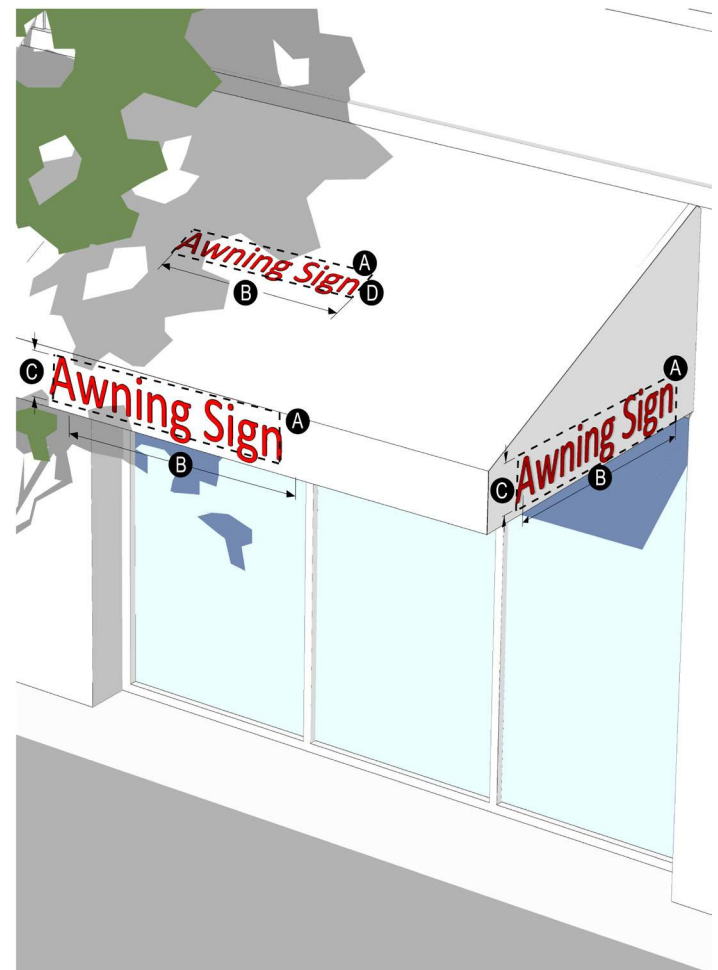

Section V: Sign Standards

Building Sign: Canopy Sign

Description

A canopy sign is a type of building sign that is attached above, below or to the face of a canopy.

General Provisions

- A canopy sign cannot extend outside the overall length or width of the canopy. However, a canopy sign may extend above or below the canopy provided the sign meets all other design standards.
- Maximum of one sign per canopy face.
- Raceways are permitted for signs extending below or above the canopy.
- A canopy sign can be externally or internally illuminated in accordance with page 118.
- Cabinet signs are not permitted as canopy signs.
 - » See the Canopies section of the Downtown Code for additional information on the design of canopies.
- This definition does not include freestanding canopies over fuel pumps. See the Auto-oriented canopy/awning Signs on page 105.



Design Standards

A Overall area allocation (max)	See pages 109-110
B Sign Width (max % of canopy length or depth)	75%
C Height of text and graphics (max)	2 feet
D Depth (max)	13 inches
E Exposed Raceway height (max)	50% of the letter height, OR if the Raceway is used as the sign background, the Raceway may extend 3 inches beyond the largest part of the sign.

Refer to the Illumination section (pages 118) for additional raceways standards and permitted locations.



Section V: Sign Standards

Building Sign: Projecting Sign

Description

A projecting sign is a type of building sign that projects outward from the facade, typically at a ninety degree angle. Projecting signs are typically, but not always, vertically oriented and generally mounted above the first floor.



General Provisions

- A projecting sign must be located at least 25 feet from any other projecting sign. When building width prohibits adherence to this standard, flexibility shall be permitted though a Minor Modification to be reviewed by staff.
- A projecting sign may be erected on a building corner when the building corner adjoins the intersection of two streets. Allocation of sign area from both streets may be used, however, in no case shall the sign exceed the maximum dimensional standards below.
- A projecting sign shall be located below the window sills of the fourth story.
- The top of a projecting sign shall not extend above the building eave or top of parapet, except on one story buildings where the top of a projecting sign may have a maximum of 20% of the sign height above the top of the building.
- A projecting sign can be externally or internally illuminated in accordance with pages 118.



Design Standards

A	Overall area allocation (max)	See pages 109-110
B	Height (max)	
	1 story buildings	10 feet
	2 and 3 story buildings	16 feet
	4 or more story buildings	20 feet
C	Spacing from facade (min)	1 foot
D	Projection Width (max)	6 feet
E	Depth of cabinet (max)	18 inches

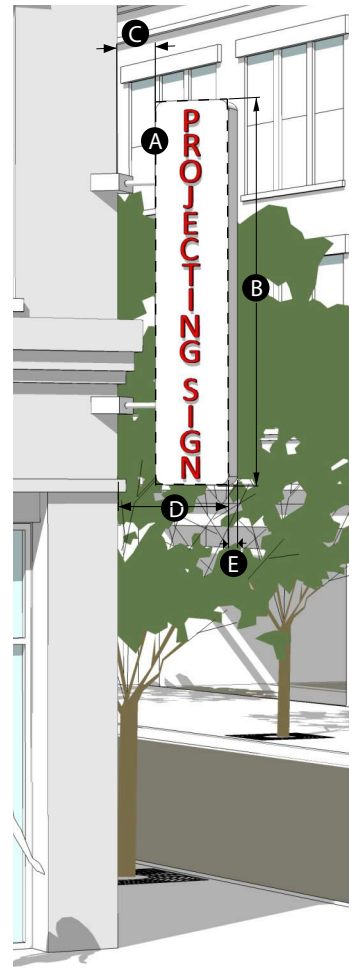
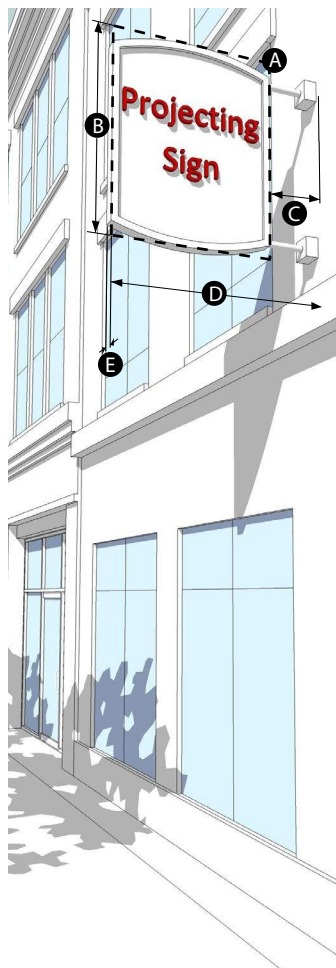

Section V: Sign Standards

Building Sign: Shingle Sign

Description

A shingle sign is a smaller building sign that projects outward, typically at a ninety degree angle, and hangs from a bracket or support that is located over or near a building entrance.

General Provisions

- Signs shall be located within 8 feet of an active pedestrian building entrance. This does not include service entries or entries that primarily remain locked.
- An active pedestrian entrance at the corner of a building is allowed signs on both streets.
- A shingle sign shall be located below the window sills of the second story.
- A shingle sign shall not be internally illuminated.



Design Standards

A Area (max)	9 square feet
B Height (max)	3 feet
C Spacing from facade (min)	6 inches
D Width (max)	3 feet
E Depth (max)	6 inches



Section V: Sign Standards

Ground Sign: Monument Sign

Description

A monument sign is a ground sign that is attached along its entire length to a continuous pedestal.

General Provisions

- Each property fronting on a Street Type which allows a monument sign is permitted one per street frontage. One additional monument sign is allowed for properties with 300 or more feet of street frontage on one street. Where more than one sign is permitted, signs along the same street frontage shall be spaced a minimum of 200 feet apart.
- A monument sign must be set back at least 5 feet from the front property line.
- A sign erected on the top of a retaining wall is required to meet the standards for a monument sign. The height of the wall shall be included in the overall height calculation. In this case, the 5 foot minimum setback is not required.
- A sign affixed to the face of a retaining wall or seat wall that is an integral part of a plaza or streetscape design may utilize the sign area allocated to wall signs. In this case, the 5 foot minimum setback is not required.
- A monument sign can be externally or internally illuminated in accordance with page 118.



Design Standards

<p>A Sign area (max per sign)</p> <p>B Height (max)</p> <p style="padding-left: 20px;">Pedestrian Street</p> <p style="padding-left: 20px;">Transitional Street</p> <p style="padding-left: 20px;">Gateway Street</p> <p>C Depth (max)</p>	<p>See pages 109-110</p> <p>5 feet</p> <p>10 feet</p> <p>15 feet</p> <p>18 inches</p>
---	---

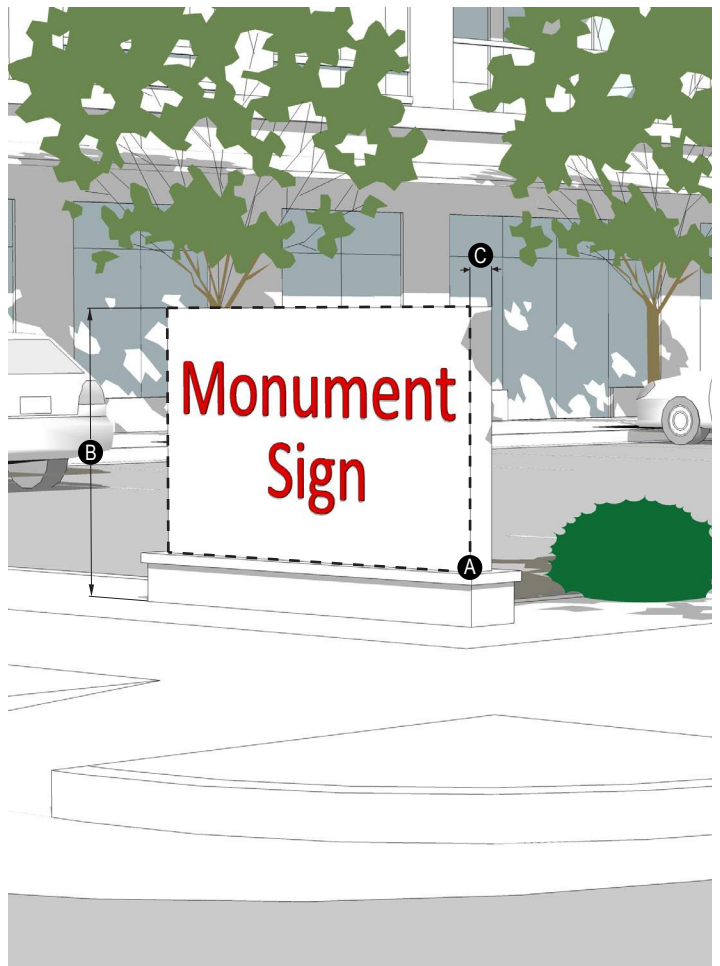

Section V: Sign Standards

Skyline Sign

Description

A building sign is attached flat to or mounted away from the building facade. Sign may be parallel to the building facade or vertical. Located on the upper band of a building.

General Standards

- A skyline sign is only allowed on buildings greater than 75 feet in height.
- A skyline sign must be located within the top third of the building.
- No portion of a skyline sign may extend above the roof line or above a parapet wall of a building with a flat roof.
- No more than one skyline sign per facade is allowed. However, additional skyline signs may be allowed as a Modification for Exceptional Design. See additional information on page 104.
- Raceways are not permitted on skyline signs.
- A skyline sign can be internally (but not externally) illuminated in accordance with page 118.
- Skyline signs may be placed on non street-facing facades through the minor modification process.

Design Standards

Ⓐ Area (max)	See pages 109-110
Ⓑ Height (max)	14 feet
Ⓒ Width (max % of facade length)	60%

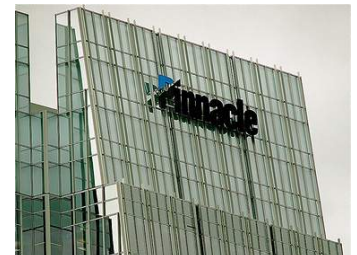

Section V: Sign Standards

Illumination

Illumination of signs shall be in accordance with the following requirements:

External Illumination

- External light sources shall be placed close to, and directed onto, the sign and shielded to minimize glare into the street, sidewalks or onto adjacent properties.
- Projecting light fixtures used for externally illuminated signs shall be simple and unobtrusive in appearance. They should not obscure the sign.

Internal Illumination

- Channel letters may be internally lit or back-lit.
- For cabinet signs, the background must be opaque. Only graphics, text and logos may be illuminated, and a halo of one inch around graphics, text, and logos may be non-opaque.
- Exposed neon may be used for lettering or as an accent.

Prohibited Light Sources

The following light sources are prohibited on every Street Type except Printers' Alley:

- Blinking, flashing, chasing, and sequential lighting.
- Bare bulb illumination.

Raceways and Transformers

- Within Redevelopment Districts, raceways may only be permitted by Modification.
- Visible transformers are prohibited.



External light sources



Internally lit channel letters



Back lit channel letters



Internally lit cabinet signs with darker backgrounds

Section V: Sign Standards

Changeable Copy Signs (Manual or Electronic)

Changeable copy signs shall be in accordance with the following requirements:

Description

- Manual changeable copy sign. A sign or portion of a sign that has a readerboard for the display of text information in which each alphanumeric character, graphic or symbol is defined by objects, not consisting of an illumination device. Changeable copy is changed or re-arranged manually or mechanically without altering the face or the surface of the sign.
- Electronic changeable copy sign. A sign or portion of a sign that displays information in which each alphanumeric character, graphic, or symbol is defined by a small number of matrix elements using different combinations of light emitting diodes (LED's), fiber optics, light bulbs or other illumination devices within the sign.

Usage

- Manual changeable copy is allowed in conjunction with a wall sign, pylon sign or monument sign.
- Electronic Changeable copy is allowed in conjunction with a wall sign or a monument sign provided the changeable copy portion is no greater than 50% of the built sign area.
- An electronic changeable copy sign is not allowed in a Redevelopment District or on Interstate frontage.
- Tourist-oriented businesses within Downtown Nashville may receive Modifications to allow greater sign area and use of digital technology in accordance to the process on page 104.

Spacing

- The closest edge of an electronic changeable copy sign must be a minimum distance of 100 feet from any residential zoning district or historic district boundary.
- An electronic changeable copy sign must be separated from another electronic changeable copy sign by at least 50 feet.

Duration

- Any image or message or portion of the image or message must have a static display for minimum duration of eight seconds.
- Transition time must be immediate.
- No portion of the image or message may flash, scroll, twirl, change color or in any manner imitate movement.

Brightness

- The sign must not exceed a maximum illumination of 7,500 nits during daylight hours and a maximum illumination of 750 nits between dusk to dawn as measured from the sign's face at maximum brightness.
- Electronic changeable copy signs must have an automatic dimmer control to produce a distinct illumination change from a higher illumination level to a lower level.